

20

P R I C E L I S T

26



A trustful relationship

After 30 years of success in the market of food service equipment, having acquired a remarkable network of branded customers and suppliers, as well as valuable associates, «VENTUS FOOD SERVICE EQUIPMENT & SOLUTIONS S.A.» was founded.

The main activities of «VENTUS FOOD SERVICE EQUIPMENT & SOLUTIONS S.A.» are:

- trading of professional equipment for hotels, restaurants, cafes and bars
- providing installation, maintenance and repair services for our products
- providing advisement, design and implementation services for our customers

Long-standing personal partnerships with branded factories and worldwide firms offers «VENTUS FOOD SERVICE EQUIPMENT & SOLUTIONS S.A.» the ability to provide high quality products and solutions at highly competitive prices.

The wide range of our products and our experienced partners are at your disposal.

Panagiotis Chaitaidis

CONTENTS

COOKING EQUIPMENT



- FRYERS [08]
- PASTA COOKERS [10]
- FOOD HEATING LAMPS [11]
- CONTACT GRILLS [12]
- GRIDDLE PLATES [14]
- TOASTERS [15]
- SALAMANDERS [15]
- INDUCTION COOKERS [16]
- POP CORN MAKER [17]
- KITCHEN UTENSILS [17]
- WAFFLE MAKERS [18]
- PANCAKE MAKERS [18]
- CREPE MAKERS [19]
- HOT DOG MAKERS [19]
- HEATED DISPENSERS [20]
- SOUS VIDE CIRCULATORS [21]
- FOOD DEHYDRATORS [21]
- SOUP COOKERS [21]
- BAIN MARIE [22]
- CHAFING DISH [23]
- POTATO SLICERS [24]
- BURGER PRESSERS [24]
- THERMOMETERS [25]
- SQUEEZERS [25]
- BLENDERS [26]
- PASTRY MIXERS [28]
- DOUGH MIXERS [30]
- TROLLEYS [32]

DISPLAYS



- DISPLAY REFRIGERATORS [36]
- SUBZERO BEER COOLERS [47]
- WINE COOLERS [48]
- BACK BAR COOLERS [50]
- COOLING DISPLAYS [51]
- COUNTERTOP DISPLAYS [55]
- NEUTRAL DISPLAYS [68]
- REFRIGERATED DISPLAYS [69]
- ICE CREAM [74]
- MEAT DISPLAYS [76]
- SELF SERVICE DISPLAYS [78]

FREEZERS

- CHEST FREEZERS [82]
- FLAT SLIDING GLASS LID FREEZERS [86]
- CURVED SLIDING GLASS LID FREEZERS [88]
- VERTICAL FREEZERS [89]
- ISLAND CHEST FREEZERS [90]

OVENS



- CONVECTION ELECTRIC OVENS [94]
- COMBI STEAM OVENS [99]
- PROVERS [102]
- TRAYS [103]
- GRILLS [104]
- OVEN CLEANERS [105]
- PIZZA OVENS [106]

DISHWASHERS



- NANSIE SERIES [112]
- UNDERCOUNTER [115]
- HOOD-TYPE [124]
- UTENSIL [127]
- TUNNELS [130]
- WATER SOFTENERS [132]
- ACCESSORIES [133]

ICEMAKERS



FULL ICE CUBE [138]
HOLLOW ICE CUBE [145]
FLAT ICE FLAKE [147]
STORAGE BINS [148]



HOLLOW ICE CUBE [150]
DICE ICE CUBE [151]
FLAT ICE FLAKE [153]
STORAGE BINS [154]

INOX

GREASE COLLECTORS [158]
HAND SINKS HACCP [159]
WASTE CONTAINERS [160]
WALL VENTILATION FUNNELS / FILTERS [160]
SHELVES [161]
RACKS [162]
GLASSWARE CABINETS [164]
WORKING TABLES [165]
TABLES WITH SINK [166]
REFRIGERATED COUNTERS [170]
REFRIGERATED SALAD COUNTERS [178]
CABINETS [179]
HEATING CABINETS [183]
BAR STATIONS [184]
COFFEE STATIONS [185]
GASTRONORME CONTAINERS [186]

BLAST CHILLERS SHOCK FREEZERS



BLAST CHILLERS/SHOCK FREEZERS [188]

KITCHEN EQUIPMENT



COUNTERTOP ELECTRIC STOVES [194]
COUNTERTOP GAS STOVES [195]
COUNTERTOP ELECTRIC FRYERS [196]
BAIN MARIE & NEUTRALS [197]
ELECTRIC GRIDDLE PLATES [198]
ELECTRIC CHROMIUM GRIDDLE PLATES [199]
GAS GRIDDLE PLATES [200]
GAS CHROMIUM GRIDDLE PLATES [201]
ELECTRIC WATER GRILLS [202]
ELECTRIC & GAS RANGES WITH OVEN [202]
FLOOR MOUNTED GAS FRYERS [203]
FLOOR MOUNTED ELECTRIC & GAS
PASTA COOKERS [204]
ELECTRIC & GAS TILTING BRATT PANS [204]
FLOOR MOUNTED INDUCTION COOKERS [205]
GAS FREE STANDING RANGES [205]

DOORS COLD ROOMS SHELVES



DOORS [208]
REFRIGERATION SYSTEMS [213]
COLD ROOMS [215]
COLD ROOM SHELVES [216]

SUPPLIERS



INDEX

- ACCESSORIES [133]
- BACK BAR COOLERS [50]
- BAIN MARIE [22, 197]
- BAR STATIONS [184]
- BLAST CHILLERS/SHOCK FREEZERS [188]
- BLENDERS [26]
- BURGER PRESSERS [24]
- CABINETS [179]
- CHAFING DISH [23]
- CHEST FREEZERS [82]
- COFFEE STATIONS [185]
- COLD ROOM SHELVES [216]
- COLD ROOMS [215]
- COMBI STEAM OVENS [99]
- CONTACT GRILLS [12]
- CONVECTION ELECTRIC OVENS [94]
- COOLING DISPLAYS [51]
- COUNTERTOP DISPLAYS [55]
- COUNTERTOP ELECTRIC FRYERS [196]
- COUNTERTOP ELECTRIC STOVES [194]
- COUNTERTOP GAS STOVES [195]
- CREPE MAKERS [19]
- CURVED SLIDING GLASS LID FREEZERS [88]
- DICE ICE CUBE [151]
- DISPLAY REFRIGERATORS [36]
- DOORS [208]
- DOUGH MIXERS [30]
- FLAT ICE FLAKE [147]
- FLAT SLIDING GLASS LID FREEZERS [86]
- FLOOR MOUNTED GAS FRYERS [203]
- FLOOR MOUNTED INDUCTION COOKERS [205]
- FOOD DEHYDRATORS [21]
- FOOD HEATING LAMPS [11]
- FRYERS [08]
- FULL ICE CUBE [138, 150]
- GAS CHROMIUM GRIDDLE PLATES [201]
- GAS FREE STANDING RANGES [205]
- GAS GRIDDLE PLATES [200]
- GASTRONORME CONTAINERS [186]
- GLASSWARE CABINETS [164]
- GREASE COLLECTORS [158]
- GRIDDLE PLATES [14]
- GRIDDLE PLATES [198]
- GRIDDLE PLATES CHROMIUM [199]
- GRILLS [104]
- HAND SINKS HACCP [159]
- HEATED DISPENSERS [20]
- HEATING CABINETS [183]
- HOLLOW ICE CUBE [145]
- HOLLOW ICE CUBE [150]
- HOOD-TYPE [124]
- HOT DOG MAKERS [19]
- ICE CREAM [74]
- INDUCTION COOKERS [16]
- ISLAND CHEST FREEZERS [90]
- KITCHEN UTENSILS [17]
- MEAT DISPLAYS [76]
- NANSIE SERIES [112]
- NEUTRAL DISPLAYS [68]
- NEUTRALS [197]
- OVEN CLEANERS [105]
- PANCAKE MAKERS [18]
- PASTA COOKERS [10]
- PASTA COOKERS [204]
- PASTRY MIXERS [28]
- PIZZA OVENS [106]
- POP CORN MAKER [17]
- POTATO SLICERS [24]
- PROVERS [102]
- RACKS [162]
- RANGES WITH OVEN [202]
- REFRIGERATED COUNTERS [170]
- REFRIGERATED DISPLAYS [69]
- REFRIGERATED SALAD COUNTERS [178]
- REFRIGERATION SYSTEMS [213]
- SALAMANDERS [15]
- SELF SERVICE DISPLAYS [78]
- SHELVES [161]
- SOUP COOKERS [21]
- SOUS VIDE CIRCULATORS [21]
- SQUEEZERS [25]
- STORAGE BINS [148, 154]
- SUBZERO BEER COOLERS [47]
- TABLES WITH SINK [166]
- THERMOMETERS [25]
- TILTING BRATT PANS [204]
- TOASTERS [15]
- TRAYS [103]
- TROLLEYS [32]
- TUNNELS [130]
- UNDERCOUNTER [115]
- UTENSIL [127]
- VERTICAL FREEZERS [89]
- WAFFLE MAKERS [18]
- WALL VENTILATION FUNNELS / FILTERS [160]
- WASTE CONTAINERS [160]
- WATER GRILLS [202]
- WATER SOFTENERS [132]
- WINE COOLERS [48]
- WORKING TABLES [165]

01

COOKING

EQUIPMENT

Cooking equipment

FRYERS [08]
PASTA COOKERS [10]
FOOD HEATING LAMPS [11]
CONTACT GRILLS [12]
GRIDDLE PLATES [14]
TOASTERS [15]
SALAMANDERS [15]
INDUCTION COOKERS [16]
POP CORN MAKER [17]
KITCHEN UTENSILS [17]
WAFFLE MAKERS [18]
PANCAKE MAKERS [18]
CREPE MAKERS [19]
HOT DOG MAKERS [19]
HEATED DISPENSERS [20]
SOUS VIDE CIRCULATORS [21]
FOOD DEHYDRATORS [21]
SOUP COOKERS [21]
BAIN MARIE [22]
CHAFING DISH [23]
POTATO SLICERS [24]
BURGER PRESSERS [24]
THERMOMETERS [25]
SQUEEZERS [25]
BLENDERS [26]
PASTRY MIXERS [28]
DOUGH MIXERS [30]
TROLLEYS [32]

COOKING EQUIPMENT
FRYERS

FRY EC04

ELECTRIC SINGLE FRYER

DIMENSIONS: 180x410x290 mm
BASKET DIMENSIONS: 10x23x9 cm
POWER: 2500 W - 230V
TEMPERATURE: 60 - 200°C
CAPACITY: 4 lt

INFO

Stainless steel casing
Safety thermostat
Basket with moulded handle
Removable oil container

89 € + V.A.T.

NEW



FRY EC06

ELECTRIC SINGLE FRYER

DIMENSIONS : 290x440x310mm
POWER : 2500 W - 220 V - 60 Hz
TEMPERATURE: 60 - 200°C
CAPACITY: 6 lt

INFO

Stainless steel casing
Safety thermostat
Basket with moulded handle
Removable oil container

65 € + V.A.T.

NEW



FRY EC066

ELECTRIC DOUBLE FRYER

DIMENSIONS: 550x440x300 mm
POWER: 2500+2500 W - 220 V - 60 Hz
TEMPERATURE: 60 - 200°C
CAPACITY: 6+6 lt

INFO

Stainless steel casing
Safety thermostat
Basket with moulded handle
Removable oil container

115 € + V.A.T.

NEW



FRY Z8

ELECTRIC SINGLE FRYER



DIMENSIONS : 270x430x350 mm
POWER : 3200 W - 230 V
TEMPERATURE: 60 - 200°C
CAPACITY: 8 lt

INFO

Stainless steel casing
Safety thermostat
Basket with moulded handle
Removable oil container

130 € + V.A.T.

NEW

FRY Z88

ELECTRIC DOUBLE FRYER



DIMENSIONS: 550x430x350 mm
POWER : 3200w+3200 W - 230 V - 50 Hz
TEMPERATURE: 60 - 200°C
CAPACITY: 8+8 lt

INFO

Stainless steel casing
Safety thermostat
Basket with moulded handle
Removable oil container

280 € + V.A.T.

NEW

FRY ST8

ELECTRIC SINGLE 3 PHASE FRYER



DIMENSIONS: 280x500x350 mm
BASKET DIMENSIONS: 20x22x12 cm
POWER: 5000 W - 380 V
TEMPERATURE: 60 - 200°C
CAPACITY: 10 lt

INFO

Stainless steel casing
Safety thermostat
Oil tap

298 € + V.A.T.

NEW

FRYERS

FRY ST9

ELECTRIC SINGLE 3 PHASE FRYER

DIMENSIONS: 310x510x370 mm
POWER: 6000 W - 380 V
TEMPERATURE: 60 - 200°C
CAPACITY: 13 lt

INFO

Stainless steel casing
Safety thermostat
Oil tap

315 € + V.A.T.

NEW



FRY ST99

ELECTRIC DOUBLE 3 PHASE FRYER

DIMENSIONS: 630x510x370 mm
POWER: 6000+6000 W - 380 V
TEMPERATURE: 60 - 200°C
CAPACITY: 13+13 lt

INFO

Stainless steel casing
Safety thermostat
Oil tap

590 € + V.A.T.

NEW



PASTA COOKERS

VEP 4

ELECTRIC PASTA COOKER 4 BASKETS

DIMENSIONS: 430x600x340 mm
POWER: 4000 Watt - 220 V

INFO

Stainless steel casing
Stainless steel resistors
Round wire basket
Oil tap

260 € + V.A.T.



FOOD HEATING LAMPS

KBS

HEATING

INFO

Intensity adjustment dimmer
Ceramic resistors
Suitable for shelf installation



MODEL	DIMENSIONS	POWER	
KBS 72	700x120x80 mm	700 Watt	210 € + V.A.T. NEW
KBS 92	900x120x80 mm	700 Watt	220 € + V.A.T. NEW
KBS 113	1100x120x80 mm	1050 Watt	235 € + V.A.T. NEW
KBS 133	1300x120x80 mm	1050 Watt	245 € + V.A.T. NEW
KBS 154	1500x120x80 mm	1400 Watt	260 € + V.A.T. NEW
KBS 174	1700x120x80 mm	1400 Watt	270 € + V.A.T. NEW
KBS 195	1900x120x80 mm	1750 Watt	300 € + V.A.T. NEW



522360

FOOD HEATING LAMP

DIMENSIONS: 600x335x580 mm
POWER: 500 Watt - 230 V

INFO

Stainless steel casing
2 lamps
Suitable for GN 1/1 containers

259 € + V.A.T.



VE 33BR/33BL/33SL

FOOD HEATING LAMP

POWER: 250 Watt - 230 V
DIAMETER: Ø 270 mm
COLOR: Copper | Black | Silver

INFO

Adjustable height 600-1800 mm

99 € + V.A.T.



VE 32BR/32BL/32SL

FOOD HEATING LAMP

POWER: 250 Watt - 230 V
DIAMETER: Ø 175 mm
COLOR: Copper | Black | Silver

INFO

Adjustable height 600-1600 mm

95 € + V.A.T.

COOKING EQUIPMENT
CONTACT GRILLS

811100

CONTACT GRILL SINGLE

DIMENSIONS: 310x320x210 mm
TOP PLATE DIMENSIONS: 213x213 mm
BOTTOM PLATE DIMENSIONS: 240x238 mm
POWER: 1.8 Kw / 220V / 50Hz
TEMPERATURE: 50 - 300°C
PLATE: Top & bottom ribbed cast iron plates

INFO

Stainless steel casing
Grease drawer

195 € + V.A.T.



812100

CONTACT GRILL MEDIUM

DIMENSIONS: 430x340x210 mm
TOP PLATE DIMENSIONS: 338x218 mm
BOTTOM PLATE DIMENSIONS: 358x233 mm
POWER: 2.2 Kw / 220V / 50Hz
TEMPERATURE: 50 - 300°C
PLATE: Top & bottom ribbed cast iron plates

INFO

Stainless steel casing
Grease drawer

225 € + V.A.T.



813100

CONTACT GRILL DOUBLE

DIMENSIONS: 570x305x210 mm
TOP PLATE DIMENSIONS: 218x218 mm
BOTTOM PLATE DIMENSIONS: 496x236 mm
POWER: 1.8+1.8 Kw / 220V / 50Hz
TEMPERATURE: 50 - 300°C
PLATE: Top & bottom ribbed cast iron plates

INFO

Stainless steel casing
Grease drawer

405 € + V.A.T.





813110

CONTACT GRILL DOUBLE

DIMENSIONS: 570x305x210 mm
TOP PLATE DIMENSIONS: 218x218 mm
BOTTOM PLATE DIMENSIONS: 496x236 mm
POWER: 1.8+1.8 Kw / 220V / 50Hz
TEMPERATURE: 50 - 300°C
PLATE: Top & bottom ribbed cast iron plates

INFO

Stainless steel casing
Grease drawer

405 € + V.A.T.

NEW



814100

CONTACT GRILL DOUBLE

DIMENSIONS: 835x390x210 mm
TOP PLATE DIMENSIONS: 320x210 mm
BOTTOM PLATE DIMENSIONS: 340x230 mm
POWER: 2.2+2.2 Kw / 220V / 50Hz
TEMPERATURE: 50 - 300°C
PLATE: Top & bottom ribbed cast iron plates

INFO

Stainless steel casing
Grease drawer

480 € + V.A.T.

NEW



815100

CONTACT GRILL MEDIUM

DIMENSIONS: 430x390x210 mm
POWER: 2.2 Kw / 220V / 50Hz
TEMPERATURE: 50 - 300°C
PLATE: Top & bottom smooth cast iron plates

INFO

Stainless steel casing
Grease drawer

235 € + V.A.T.

NEW



822100

CONTACT GRILL MEDIUM

DIMENSIONS: 430x390x210 mm
POWER: 2.2 Kw / 220V / 50Hz
TEMPERATURE: 50 - 300°C
PLATE: Top ribbed & bottom smooth cast iron plates

INFO

Stainless steel casing
Grease drawer

245 € + V.A.T.

NEW



COOKING EQUIPMENT

GRIDDLE PLATES

VEG 818A

ELECTRIC GRIDDLE PLATE

DIMENSIONS: 550x410x210 mm
POWER: 3000 W - 230 V
TEMPERATURE: 50 - 300°C
PLATE: Smooth

INFO
Stainless steel casing
Grease drawer

198 € + V.A.T.

NEW



VEG 818B

ELECTRIC GRIDDLE PLATE

DIMENSIONS: 360x390x190 mm
POWER: 1500 W - 230 V
TEMPERATURE: 50 - 300°C
PLATE: Smooth

INFO
Stainless steel casing
Grease drawer

115 € + V.A.T.

NEW



VEG 820Z

ELECTRIC GRIDDLE PLATE

DIMENSIONS: 735x510x220 mm
SURFACE DIMENSIONS: 725x400 mm
POWER: 4400 W - 230 V
TEMPERATURE: 50 - 300°C
PLATE: Smooth

INFO
Stainless steel casing
Grease drawer

215 € + V.A.T.

NEW



VEG 822Z

ELECTRIC GRIDDLE PLATE

DIMENSIONS: 735x510x220 mm
POWER: 4400 W - 230 V
TEMPERATURE: 50 - 300°C
PLATE: Half smooth / Half ribbed

INFO
Stainless steel casing
Grease drawer

245 € + V.A.T.

NEW

TOASTERS



VE 4AM

4-SLICE TOASTER

DIMENSIONS: 370x210x225 mm
POWER: 2300 Watt - 230 V
CAPACITY: 4 slots

INFO

Stainless steel casing
Timer

165 € + V.A.T.



VE 6AM

6-SLICE TOASTER

DIMENSIONS: 460x210x225 mm
POWER: 3240 Watt - 230 V
CAPACITY: 6 slots

INFO

Stainless steel casing
Timer

205 € + V.A.T.

SALAMANDERS



VE 450

SALAMANDER

DIMENSIONS: 450x520x520 mm
GRID DIMENSIONS: 440x320 mm
POWER: 2800 Watt - 230 V

INFO

Stainless steel casing
Top thermal resistor
Adjustable height top part
Chrome grid

890 € + V.A.T.



VE 600

SALAMANDER

DIMENSIONS: 600x520x520 mm
GRID DIMENSIONS: 590x320 mm
POWER: 4000 Watt - 230 V

INFO

Stainless steel casing
Top thermal resistor
Adjustable height top part
Chrome grid

965 € + V.A.T.

COOKING EQUIPMENT
INDUCTION COOKERS

300108

DIGITAL INDUCTION COOKER

DIMENSIONS: 340x440x120 mm
PLATE DIMENSIONS: 285x285 mm
POWER: 3500 Watt / 230 V
TEMPERATURE: 35°C - 240°C
FANS: 4

INFO

Stainless steel casing
Suitable for induction utensils Ø120-300 mm

320 € + V.A.T.



300112

DIGITAL INDUCTION COOKER

DIMENSIONS: 290x370x60 mm
PLATE DIMENSIONS: 290x370 mm
POWER: 2000 Watt / 230 V
TEMPERATURE: 60°C - 240°C
FANS: 1

INFO

Plastic casing
Suitable for induction utensils Ø120-260 mm

120 € + V.A.T.



600201

DIGITAL INDUCTION ANALOG

DIMENSIONS: 410x770x120 mm
PLATE DIMENSIONS: 340x585 mm
POWER: 3500+3500 Watt / 230 V
TEMPERATURE: 60°C - 240°C
FANS: 4

INFO

Stainless steel casing
Suitable for induction utensils Ø120-240 mm

1.190 € + V.A.T.



POP CORN



VE 6BC

POP CORN MAKER

DIMENSIONS: 560x420x760 mm

POWER: 1440 Watt - 230 V

INFO

Production 80z

320 € + V.A.T.

KITCHEN UTENSILS



 **stalgast**
professional catering equipment

249338-249558

MAGNETIC KNIVES' RACK

249338 | 330 mm

7,70 € + V.A.T.

249558 | 550 mm

11,90 € + V.A.T.

INFO

Knives not included.



099102-105

ALUMINIUM TAP GRAPPER

099102 | 450 mm

14,40 € + V.A.T.

099103 | 600 mm

19,20 € + V.A.T.

099104 | 900 mm

28,50 € + V.A.T.

099105 | 1200 mm

38 € + V.A.T.

COOKING EQUIPMENT

WAFFLE MAKERS



VE RW 1

ANALOG ROUND WAFFLE MAKER

DIMENSIONS: 250x540x300 mm
WAFFLE DIMENSIONS: Ø185 mm
TEMPERATURE: 50°C - 300°C
POWER: 1.2 Kw - 220 V / 50 Hz

INFO

Stainless steel casing
Non-stick plates
Rotating

215 € + V.A.T.



VE DRW 1

DIGITAL ROUND WAFFLE MAKER

DIMENSIONS: 250x540x300 mm
WAFFLE DIMENSIONS: Ø185 mm
TEMPERATURE: 50°C - 300°C
POWER: 1.2 Kw - 220 V / 50 Hz

INFO

Stainless steel casing
Non-stick plates
Rotating

335 € + V.A.T.

PANCAKES MAKERS



VEH 9

PANCAKE MAKER

DIMENSIONS: 310x350x180 mm
PLATE SURFACE: 250X250 mm
POWER: 900 W - 220 V / 50 Hz
CAPACITY: 9 spaces
BAKING MOLD DEPTH: 10 mm
WAFFLE DIAMETER: Ø76 mm

INFO

Stainless steel construction

160 € + V.A.T.



VEH 9 TOP

PANCAKE MAKER WITH TOP

DIMENSIONS: 320x370x240 mm
POWER: 1750 W - 220 V / 50 Hz
CAPACITY: 9 spaces
BAKING MOLD DEPTH: 10 mm
WAFFLE DIAMETER: Ø76 mm

INFO

Stainless steel construction

305 € + V.A.T.

CREPE MAKERS



VECR 1

1-PLATE ELECTRIC CREPE MAKER

DIMENSIONS: 430x485x240 mm
DIAMETER: Ø40 mm
TEMPERATURE: 50°C - 300°C
POWER: 3 Kw - 220 V / 50 Hz

INFO

Stainless steel construction
Drawer
Non-stick plates

210 € + V.A.T.



VECR 2

2-PLATES ELECTRIC CREPE MAKER

DIMENSIONS: 880x485x240 mm
DIAMETER: Ø40 mm
TEMPERATURE: 50°C - 300°C
POWER: 3+3 Kw - 220 V / 50 Hz

INFO

Stainless steel construction
Drawer
Non-stick plates

450 € + V.A.T.

HOT DOG MAKERS



VE HDO0

HOT DOG MAKER

DIMENSIONS: 305x320x420 mm
POWER: 450 W - 220 V / 50Hz
TEMPERATURE: 170°C

INFO

Stainless steel construction

205 € + V.A.T.



VE HDO3

STEAM HOT DOG MAKER WITH BREAD HEATERS

DIMENSIONS: 550x290x380 mm
POWER: 700W - 220 V / 50Hz
TEMPERATURE: 170°C

INFO

Stainless steel construction
3 sticks for heating or warming bread

290 € + V.A.T.

COOKING EQUIPMENT

DEHYDRATORS

VE FD6

6-GRIDS FOOD DEHYDRATOR

DIMENSIONS: 320x360x350mm
CAPACITY: 6 grids
GRID DIMENSIONS: 280x200 mm
SPACE BETWEEN GRIDS: 4.6 cm
POWER: 400W / 220 V / 50Hz
TEMPERATURE: 35°C up to 90°C

INFO
Stainless steel casing

230 € + V.A.T.



VE FD10

10-GRIDS FOOD DEHYDRATOR

DIMENSIONS: 420x460x440 mm
CAPACITY: 10 grids
GRID DIMENSIONS: 380x290 mm
SPACE BETWEEN GRIDS: 3.5 cm
POWER: 1000W / 220 V / 50Hz
TEMPERATURE: 35°C up to 90°C

INFO
Stainless steel casing

325 € + V.A.T.

SOUP MAKER

SK 10L

SOUP MAKER

DIMENSIONS: 320x320x360mm
CAPACITY: 10 Ltr
POWER: 400W - 220 V - 50Hz
TEMPERATURE: 30°C up to 80°C

85 € + V.A.T.



SOUS VIDE



SV 150A

SOUS VIDE CIRCULATOR

DIMENSIONS: 140x110x323 mm

POWER: 1500 Watt - 230 V

INFO

Digital display

Suitable for water container up to 30 lt

415 € + V.A.T.



HEATED DISPENSERS



CW 04

HEATED DISPENSER

DIMENSIONS: 230x420x390 mm

POWER: 550 Watt - 230 V

TEMPERATURE: up to 99°C

INFO

Heated nozzle

Stainless steel construction

Suitable for cheddar

425 € + V.A.T.



EXTRA

053048

Internal bowl for CW04

30 € + V.A.T.

BAIN MARIE

BM 1502V

COUNTERTOP BAIN MARIE

DIMENSIONS: 570x430x270 mm
CAPACITY: 2 GN 1/2 150 mm
POWER: 1.5 kW / 220 V
TEMPERATURE: 30°C up to 110°C

INFO

Stainless steel casing
Oil tap

175 € + V.A.T.



BM 1502VWT

COUNTERTOP BAIN MARIE

DIMENSIONS: 570x430x270 mm
CAPACITY: 2 GN 1/2 150 mm
POWER: 1.5 kW / 220 V
TEMPERATURE: 30°C up to 110°C

INFO

Stainless steel casing

165 € + V.A.T.



CHAFING DISH



VE 355

CHAFING DISH

DIMENSIONS: 600x350x320 mm
CAPACITY: 9 Ltr

INFO

Included:
2 fuel holders
1 GN 1/1-65 mm

85 € + V.A.T.



VE 357

CHAFING DISH ROLL TOP

DIMENSIONS: 640x440x450 mm
CAPACITY: 9 Ltr

INFO

Roll top 180°
Included:
2 fuel holders
1 GN 1/1-65 mm

175 € + V.A.T.



VE 359

CHAFING DISH

DIMENSIONS: 420x340x330 mm
CAPACITY: 9 Ltr

INFO

Included:
1 fuel holder

80 € + V.A.T.

COOKING EQUIPMENT

POTATO SLICERS



VEG 04 INOX

MANUAL POTATO SLICER

DIMENSIONS: 280x170x215 mm

INFO

Including 4 knives:
6 mm, 9 mm, 13 mm & for 8 pcs

160 € + V.A.T.

NEW



BURGER PRESSERS



VH 130

MANUAL BURGER PRESSER

DIMENSIONS: 275x230x300 mm
DIAMETER: Ø 130 mm

INFO

Anodised aluminium body
Stainless steel internal
Non-slip feet

210 € + V.A.T.



THERMOMETERS



THE 500UN

ANALOG THERMOMETER

TEMPERATURE: -40 up to +50°C

4 € + V.A.T.



THE 501UN

ANALOG THERMOMETER

TEMPERATURE: -40 up to +40°C

4 € + V.A.T.



THE 005UN

DIGITAL THERMOMETER WITH PROBE

TEMPERATURE: -50 up to +300°C

INFO

Stainless steel probe
Probe length 110 mm
Battery LR44 (included)

11 € + V.A.T.

SQUEEZERS



VE 180 N

ELECTRIC SQUEEZER

DIMENSIONS: 190x300x340 mm

POWER: 180 Watt

ROTATION SPEED: 1400 rpm

COLOR: Black

INFO

2 cones included

167 € + V.A.T.

COOKING EQUIPMENT
BLENDERS

1052

ANALOG BLENDER

DIMENSIONS: 210x210x540 mm
JAR CAPACITY: 2 lt
POWER: 1800 Watt - 220 V
ROTATION SPEED: 28000-30000 Rpm
SPEED SETTINGS: 10 levels & Pulse function

INFO

Stainless steel blades
Polycarbonate blender jar
Non-slip base

195 € + V.A.T.



010

ANALOG BLENDER

DIMENSIONS: 175x215x480 mm
JAR CAPACITY: 2 lt
POWER: 1500 Watt / 3Hp
ROTATION SPEED: 26000-28000 rpm
SPEED SETTINGS: Adjustable & Pulse function

INFO

Stainless steel blades
Polycarbonate blender jar
Non-slip base

158 € + V.A.T.





VBL 806

ANALOG BLENDER

DIMENSIONS: 210x220x460 mm
JAR CAPACITY: 2 lt
POWER: 1500 Watt
ROTATION SPEED: 22000-32000 Rpm
SPEED SETTINGS: Adjustable & Pulse function

INFO

Stainless steel blades
Polycarbonate blender jar
Non-slip base
Grey color

155 € + V.A.T.



VBL 836

DIGITAL BLENDER

DIMENSIONS: 220x230x490 mm
JAR CAPACITY: 2 lt
POWER: 1500 Watt
ROTATION SPEED: 22000-32000 Rpm
SPEED SETTINGS: Adjustable & Pulse function

INFO

Stainless steel blades
Polycarbonate blender jar
Non-slip base
Soundproof cover
Black color

310 € + V.A.T.

COOKING EQUIPMENT
PASTRY MIXERS



B7W 500

PASTRY MIXER

DIMENSIONS: 380x235x405 mm
CAPACITY: 7 lt
POWER: 500 Watt
SPEED: Adjustable 75-680 rpm
COLOR: White

INFO

Stainless steel bowl
Max flour quantity 750 gr
Mixing cream 1500 gr
Included: shovel, dough hook & balloon whisk

765 € + V.A.T.



B7R 500

PASTRY MIXER

DIMENSIONS: 380x235x405 mm
CAPACITY: 7 lt
POWER: 500 Watt
SPEED: Adjustable 75-680 rpm
COLOR: Red

INFO

Stainless steel bowl
Max flour quantity 750 gr
Mixing cream 1500 gr
Included: shovel, dough hook & balloon whisk

765 € + V.A.T.



B7S 500

PASTRY MIXER

DIMENSIONS: 380x235x405 mm
CAPACITY: 7 lt
POWER: 500 Watt
SPEED: Adjustable 75-680 rpm
COLOR: Inox

INFO

Stainless steel
Max flour quantity 750 gr
Mixing cream 1500 gr
Included: shovel, dough hook & balloon whisk

878 € + V.A.T.

B10S 500

PASTRY MIXER

DIMENSIONS: 380x235x445 mm
CAPACITY: 10 lt
POWER: 500 Watt
SPEED: Adjustable 75-680 rpm
COLOR: Inox

INFO

Stainless steel
Max flour quantity 1000 gr
Mixing cream 2000 gr
Included: shovel, dough hook & balloon whisk

1.035 € + V.A.T.



B20S

PASTRY MIXER

DIMENSIONS: 420x530x780 mm
CAPACITY: 20 lt
SPEED: 105/180/425 rpm
POWER: 1 100 Watt / 220V / 50Hz
WEIGHT: 60 kg
COLOR: Silver

INFO

Stainless steel bowl
3 levels adjustable speed
Included: shovel, dough hook & balloon whisk

1.078 € + V.A.T.



B30S

PASTRY MIXER

DIMENSIONS: 390x450x810 mm
CAPACITY: 30 lt
SPEED: 110/200/420 rpm
POWER: 1500 Watt / 220V / 50Hz
WEIGHT: 70 kg
COLOR: Silver

INFO

Stainless steel bowl
3 levels adjustable speed
Included: shovel, dough hook & balloon whisk

1.350 € + V.A.T.



B40S

PASTRY MIXER

DIMENSIONS: 530x610x1020 mm
CAPACITY: 40 lt
SPEED: 65/102/296 rpm
POWER: 2000 Watt / 380V / 50Hz
WEIGHT: 130 kg
COLOR: Silver

INFO

Stainless steel bowl
3 levels adjustable speed
Included: shovel, dough hook & balloon whisk

2.455 € + V.A.T.

COOKING EQUIPMENT

DOUGH MIXERS

VS 10

DOUGH MIXER

DIMENSIONS: 550x340x530 mm
CAPACITY: 10 Ltr
POWER: 750 Watt / 220 V
KNEADING SPEED: Adjustable 153-213 Rpm
BOWL ROTATION SPEED: 13-20 Rpm

INFO

Stainless steel bowl
Adjustable speed
Timer
Max flour quantity 4 kg

1.590 € + V.A.T.



VS 20

DOUGH MIXER

DIMENSIONS: 730x390x900 mm
CAPACITY: 20 Ltr
POWER: 1500 Watt / 220 V
KNEADING SPEED: Adjustable 150-200 Rpm
BOWL ROTATION SPEED: 15-20 Rpm

INFO

Stainless steel bowl
Adjustable speed
Timer
Max flour quantity 8 kg

1.790 € + V.A.T.

VS 30

DOUGH MIXER

DIMENSIONS: 750x435x900 mm
CAPACITY: 34 Ltr
POWER: 1500 Watt / 220 V
KNEADING SPEED: Adjustable 150-200 Rpm
BOWL ROTATION SPEED: 15-20 Rpm

INFO

Stainless steel bowl
Adjustable speed
Timer
Max flour quantity 12 kg

1.895 € + V.A.T.



VS 40

DOUGH MIXER

DIMENSIONS: 800x480x970 mm
CAPACITY: 45 Ltr
POWER: 3000 Watt / 220 V
KNEADING SPEED: Adjustable 150-200 Rpm
BOWL ROTATION SPEED: 15-20 Rpm

INFO

Stainless steel bowl
Adjustable speed
Timer
Max flour quantity 16 kg

2.390 € + V.A.T.

VS 50

DOUGH MIXER

DIMENSIONS: 850x510x970 mm
CAPACITY: 54 Ltr
POWER: 3000 Watt / 220 V
KNEADING SPEED: Adjustable 150-200 Rpm
BOWL ROTATION SPEED: 15-20 Rpm

INFO

Stainless steel bowl
Adjustable speed
Timer
Max flour quantity 20 kg

2.995 € + V.A.T.

VS 60

DOUGH MIXER

DIMENSIONS: 850x510x970 mm
CAPACITY: 64 Ltr
POWER: 3000 Watt / 220 V
KNEADING SPEED: Adjustable 150-200 Rpm
BOWL ROTATION SPEED: 15-20 Rpm

INFO

Stainless steel bowl
Adjustable speed
Timer
Max flour quantity 25 kg

3.090 € + V.A.T.

COOKING EQUIPMENT
TROLLEYS



X 1512

**SERVING TROLLEY
WITH 3 SHELVES**

DIMENSIONS: 780x430x950 mm

159 € + V.A.T.



VE 14X

**SERVING TROLLEY
WITH 2 SHELVES**

DIMENSIONS: 950x500x950 mm

160 € + V.A.T.



VE 15X

**SERVING TROLLEY
WITH 2 SHELVES**

DIMENSIONS: 850x450x900 mm

110 € + V.A.T.



VE 11X

**SERVING TROLLEY
WITH 3 SHELVES**

DIMENSIONS: 950x500x950 mm

145 € + V.A.T.



VE 121X

**SERVING TROLLEY
WITH 2 SHELVES
WITH COLLECTION BASIN**

DIMENSIONS: 950x500x950 mm

197 € + V.A.T.



VE 124X

**SERVING TROLLEY
WITH 2 SHELVES**

DIMENSIONS: 950x500x950 mm

120 € + V.A.T.



VE 131X

**INOX MOBILE RACK
FOR 15 TRAYS 40x60 cm**

DIMENSIONS: 470x620x1735 mm

INFO

Space between: 75 mm
Wheels Ø 15 cm

225 € + V.A.T.



VE 135X

**INOX MOBILE RACK
FOR 15 GN 1/1 CONTAINERS**

DIMENSIONS: 380x550x1735 mm

INFO

Space between: 75 mm
Wheels Ø 20 cm

245 € + V.A.T.

02

DISPLAYS

Displays

DISPLAY REFRIGERATORS [36]

SUBZERO BEER COOLERS [47]

WINE COOLERS [48]

BACK BAR COOLERS [50]

COOLING DISPLAYS [51]

COUNTERTOP DISPLAYS [55]

NEUTRAL DISPLAYS [68]

REFRIGERATED DISPLAYS [69]

ICE CREAM [74]

MEAT DISPLAYS [76]

SELF SERVICE DISPLAYS [78]

DISPLAYS

DISPLAY REFRIGERATORS



VCB 315

DISPLAY REFRIGERATOR

DIMENSIONS : 556x530x1826mm
TEMPERATURE: +1°C up to +10°C
CAPACITY: 280 lt
COOLING: Ventilated
DEFROSTING: Manual
POWER: 220 Watt
REFRIGERANT: R600a
THERMOSTAT: Analog
SHELVES: 4 adjustable

INFO

Lock
Led illumination
Door opening left to right
Colour: white internal & external

720 € + V.A.T.



VCB 375

DISPLAY REFRIGERATOR

DIMENSIONS: 615x600x1950 mm
TEMPERATURE: +1°C up to +10°C
CAPACITY: 375 lt
COOLING: Ventilated
DEFROSTING: Manual
POWER: 300 Watt
REFRIGERANT: R600a
THERMOSTAT: Analog
SHELVES: 4 adjustable

INFO

Lock
Led illumination
Canopy illumination
Door opening left to right
Colour: white internal & gray external

798 € + V.A.T.

VCB 335 FULL BLACK

DISPLAY REFRIGERATOR

DIMENSIONS : 575x525x1770mm
TEMPERATURE: +1°C up to +10°C
CAPACITY: 285 lt
COOLING: Ventilated
DEFROSTING: Manual
POWER: 180 Watt
REFRIGERANT: R600a
THERMOSTAT: Electronic
SHELVES: 4 adjustable

INFO

Lock
Led illumination
Canopy illumination
Door opening left to right
Colour: black internal & external



695 € + V.A.T.

NEW



VCB 440 Black/RB

DISPLAY REFRIGERATOR

DIMENSIONS: 615x610x1990 mm

TEMPERATURE: +1°C up to +10°C

CAPACITY: 360 lt

COOLING: Ventilated

DEFROSTING: Manual

POWER: 265 Watt

REFRIGERANT: R600a

THERMOSTAT: Analog

SHELVES: 4 adjustable

INFO

Lock

Led illumination

Canopy illumination

Door opening left to right

Colour: white internal & black external

895 € + V.A.T.



VCB 440 Full Black/RB

DISPLAY REFRIGERATOR

DIMENSIONS: 615x610x1990 mm

TEMPERATURE: +1°C up to +10°C

CAPACITY: 360 lt

COOLING: Ventilated

DEFROSTING: Manual

POWER: 265 Watt

REFRIGERANT: R600a

THERMOSTAT: Analog

SHELVES: 4 adjustable

INFO

Lock

Led illumination

Canopy illumination

Door opening left to right

Colour: black internal & external

935 € + V.A.T.

DISPLAYS

DISPLAY REFRIGERATORS



Electronic temperature display



VCB 460 B/DG

DISPLAY REFRIGERATOR

DIMENSIONS: 615x610x1950 mm
TEMPERATURE: +1°C up to +10°C
CAPACITY: 360 lt
COOLING: Ventilated
DEFROSTING: Manual
POWER: 350 Watt
REFRIGERANT: R600a
THERMOSTAT: Analog
SHELVES: 4 adjustable

INFO

Electronic temperature display
Lock
Led illumination
Canopy illumination
Door opening left to right
Colour: white internal & black external

1.045 € + V.A.T.

VCB 460 Full B/DG

DISPLAY REFRIGERATOR

DIMENSIONS: 615x610x1950 mm
TEMPERATURE: +1°C up to +10°C
CAPACITY: 360 lt
COOLING: Ventilated
DEFROSTING: Manual
POWER: 350 Watt
REFRIGERANT: R600a
THERMOSTAT: Analog
SHELVES: 4 adjustable

INFO

Electronic temperature display
Lock
Led illumination
Canopy illumination
Door opening left to right
Colour: black internal & external

1.090 € + V.A.T.

VCB 400B

FRAMELESS DISPLAY REFRIGERATOR

DIMENSIONS: 595x620x1830 mm
TEMPERATURE: +1°C up to +10°C
CAPACITY: 385 lt
COOLING: Ventilated
DEFROSTING: Manual
POWER: 300 Watt
REFRIGERANT: R600a
THERMOSTAT: Analog
SHELVES: 5 adjustable

INFO

Lock
Led illumination
«Frameless» door, opening left to right
Analog temperature indicator
Colour: black internal & external





VCB 450B Full Black

DISPLAY REFRIGERATOR

DIMENSIONS: 650x580x1940 mm
TEMPERATURE: +2°C up to +10°C
CAPACITY: 450 lt
COOLING: Ventilated
DEFROSTING: Automatic
POWER: 240 Watt
REFRIGERANT: R600a
THERMOSTAT: Electronic
SHELVES: 4 adjustable black

INFO

Led illumination
Colour: black internal & external

1.050 € + V.A.T.



DBC 650BL

DISPLAY REFRIGERATOR

DIMENSIONS: 620x705x2050 mm
TEMPERATURE: +1°C up to +10°C
CAPACITY: 450 lt
COOLING: Ventilated
DEFROSTING: Automatic
POWER: 300 Watt
REFRIGERANT: R290
THERMOSTAT: Electronic
SHELVES: 5 adjustable

INFO

Castors
Led illumination
Door opening left to right
Colour: white internal & black external

1.345 € + V.A.T.

DISPLAYS

DISPLAY REFRIGERATORS

SLIM 230H FULL BLACK

SLIM DISPLAY REFRIGERATOR

DIMENSIONS: 420x525x1935 mm
TEMPERATURE: +1°C up to +10°C
CAPACITY: 217 lt
COOLING: Ventilated
DEFROSTING: Manual
POWER: 160 Watt
REFRIGERANT: R600a
THERMOSTAT: Analog
SHELVES: 5 adjustable

INFO

Lock
Led illumination
Door opening left to right
Colour: black internal & external

745 € + V.A.T.

NEW



SLIM 230HF PREMIUM

SLIM FRAMELESS DISPLAY REFRIGERATOR

DIMENSIONS: 420x525x1935 mm
TEMPERATURE: +1°C up to +10°C
CAPACITY: 217 lt
COOLING: Ventilated
DEFROSTING: Manual
POWER: 180 Watt
REFRIGERANT: R600
THERMOSTAT: Electronic
SHELVES: 5 adjustable

INFO

Lock
Double Led illumination
«Frameless» door with aluminium profile
Colour: black internal & external

875 € + V.A.T.

NEW





VF 120F FULL BLACK

DISPLAY REFRIGERATOR

DIMENSIONS: 545x588x837 mm
TEMPERATURE: +1°C up to +10°C
CAPACITY: 120 lt
COOLING: Ventilated
DEFROSTING: Manual
POWER: 130 Watt
REFRIGERANT: R600a
THERMOSTAT: Analog
SHELVES: 2 adjustable

INFO

Double Led illumination
Colour: black internal & external

480 € + V.A.T.



VF 105F

DISPLAY REFRIGERATOR

DIMENSIONS: 445x510x831 mm
TEMPERATURE: +1°C up to +10°C
CAPACITY: 92 lt
COOLING: Static with ventilator
DEFROSTING: Manual
POWER: 95 Watt
REFRIGERANT: R600a
THERMOSTAT: Analog
SHELVES: 4 adjustable

INFO

Led illumination
Door opening left to right
Colour: black internal & external

425 € + V.A.T.



VE 56 Black

DISPLAY REFRIGERATOR

DIMENSIONS: 495x450x495 mm
TEMPERATURE: +2°C up to +10°C
CAPACITY: 45 lt
COOLING: Static with ventilator
DEFROSTING: Manual
POWER: 75 Watt
REFRIGERANT: R600a
THERMOSTAT: Analog
SHELF: 1

INFO

Led illumination
Door opening left to right
Colour: white internal & black external

430 € + V.A.T.

DISPLAYS

DISPLAY REFRIGERATORS

VFR 60FE

FRAMELESS DISPLAY REFRIGERATOR

DIMENSIONS: 495x450x495 mm
TEMPERATURE: +4°C up to +10°C
CAPACITY: 45 lt
COOLING: Static with ventilator
DEFROSTING: Manual
POWER: 75 Watt
REFRIGERANT: R600a
THERMOSTAT: Electronic
SHELF: 1

INFO

Led illumination
«Frameless» door, opening left to right
Colour: black internal & external

550 € + V.A.T.



VFR 115FE

FRAMELESS DISPLAY REFRIGERATOR

DIMENSIONS: 495x450x825 mm
TEMPERATURE: +4°C up to +10°C
CAPACITY: 95 lt
COOLING: Static with ventilator
DEFROSTING: Manual
POWER: 95 Watt
REFRIGERANT: R600a
THERMOSTAT: Electronic
SHELVES: 3

INFO

Led illumination
«Frameless» door, opening left to right
Colour: black internal & external

765 € + V.A.T.





VFR 200SS G

DISPLAY REFRIGERATOR

DIMENSIONS : 642x646x990 mm
TEMPERATURE: +1°C up to +10°C
SHELVES: 3
COOLING: Static
DEFROSTING: Automatic
POWER: 202 Watt
REFRIGERANT: R600a
THERMOSTAT: Electronic

INFO

Lock
Led Illumination
Stainless steel construction

998 € + V.A.T.

NEW



VFR 200SS

DISPLAY REFRIGERATOR WITH INOX DOOR

DIMENSIONS : 642x646x990 mm
TEMPERATURE: +1°C up to +10°C
SHELVES: 3
COOLING: Static
DEFROSTING: Automatic
POWER: 202 Watt
REFRIGERANT: R600a
THERMOSTAT: Electronic

INFO

Lock
Led Illumination
Stainless steel construction

897 € + V.A.T.

NEW

DISPLAYS

DISPLAY REFRIGERATORS



VCB 750HF FULL BLACK

FRAMELESS DISPLAY REFRIGERATOR

DIMENSIONS: 1100x600x1985 mm

TEMPERATURE: +1°C up to +10°C

CAPACITY: 710 lt

COOLING: Ventilated

DEFROSTING: Automatic

POWER: 380 Watt

REFRIGERANT: R290

THERMOSTAT: Electronic

SHELVES: 5+5 adjustable

INFO

Led illumination

2 «frameless» revolving doors

Colour: black internal & external

1.890 € + V.A.T.

NEW



VCB 1150HF FULL BLACK

FRAMELESS DISPLAY REFRIGERATOR

DIMENSIONS: 1650x600x1985 mm

TEMPERATURE: +1°C up to +10°C

CAPACITY: 1070 lt

COOLING: Ventilated

DEFROSTING: Automatic

POWER: 460 Watt

REFRIGERANT: R290

THERMOSTAT: Electronic

SHELVES: 5+5+5 adjustable

INFO

Led illumination

3 «frameless» revolving doors

Colour: black internal & external

2.290 € + V.A.T.

NEW



DBC 1050H

DISPLAY REFRIGERATOR

DIMENSIONS: 1250x705x2050 mm
TEMPERATURE: +2°C up to +8°C
CAPACITY: 950 lt
COOLING: Ventilated
DEFROSTING: Automatic
POWER: 480 Watt
REFRIGERANT: R290
THERMOSTAT: Electronic
SHELVES: 5+5 adjustable

INFO

Led illumination
2 revolving doors
Colour: white internal & black external

2.360 € + V.A.T.



DBC 1500H

DISPLAY REFRIGERATOR

DIMENSIONS: 1880x705x2050 mm
TEMPERATURE: +2°C up to +8°C
CAPACITY: 1450 lt
COOLING: Ventilated
DEFROSTING: Automatic
POWER: 1080 Watt
REFRIGERANT: R290
THERMOSTAT: Electronic
SHELVES: 5+5+5 adjustable

INFO

Led illumination
3 revolving doors
Colour: white internal & black external

3.750 € + V.A.T.



DBC 1050HBL

DISPLAY REFRIGERATOR

DIMENSIONS: 1250x705x2050 mm
TEMPERATURE: +2°C up to +8°C
CAPACITY: 950 lt
COOLING: Ventilated
DEFROSTING: Automatic
POWER: 480 Watt
REFRIGERANT: R290
THERMOSTAT: Electronic
SHELVES: 5+5 adjustable

INFO

Led illumination
2 revolving doors
Colour: black internal & external

2.450 € + V.A.T.



DBC 2050H

DISPLAY REFRIGERATOR

DIMENSIONS: 2500x705x2050 mm
TEMPERATURE: +2°C up to +8°C
CAPACITY: 1950 lt
COOLING: Ventilated
DEFROSTING: Automatic
POWER: 1950 Watt
REFRIGERANT: R290
THERMOSTAT: Electronic
SHELVES: 5+5+5+5 adjustable

INFO

Led illumination
4 revolving doors
Colour: white internal & black external

4.950 € + V.A.T.

DISPLAY REFRIGERATORS



DBC 760BLCL

DISPLAY REFRIGERATOR

DIMENSIONS: 750x705x2075 mm
 TEMPERATURE: +1°C up to +10°C
 CAPACITY: 600 lt
 COOLING: Ventilated
 DEFROSTING: Automatic
 POWER: 300 Watt
 REFRIGERANT: R290
 THERMOSTAT: Electronic
 SHELVES: 5 adjustable

INFO

Castors
 Led illumination around the door
 Door opening left to right
 Colour: black internal & external

1.870 € + V.A.T.



DBC 1350BLCL

DISPLAY REFRIGERATOR

DIMENSIONS: 1250x705x2075 mm
 TEMPERATURE: +1°C up to +10°C
 CAPACITY: 1090 lt
 COOLING: Ventilated
 DEFROSTING: Automatic
 POWER: 480 Watt
 REFRIGERANT: R290
 THERMOSTAT: Electronic
 SHELVES: 5+5 adjustable

INFO

Castors
 Led illumination around the doors
 2 revolving doors
 Colour: black internal & external

2.995 € + V.A.T.



DBC 2590BLCL

DISPLAY REFRIGERATOR

DIMENSIONS: 1880x705x2075 mm
 TEMPERATURE: +1°C up to +10°C
 CAPACITY: 1715 lt
 COOLING: Ventilated
 DEFROSTING: Automatic
 POWER: 1080 Watt
 REFRIGERANT: R290
 THERMOSTAT: Electronic
 SHELVES: 5+5+5 adjustable

INFO

Castors
 Led illumination around the doors
 3 revolving doors
 Colour: black internal & external

4.100 € + V.A.T.



DBC 3000BLCL

DISPLAY REFRIGERATOR

DIMENSIONS: 2500x705x2175 mm
 TEMPERATURE: +1°C up to +10°C
 CAPACITY: 2360 lt
 COOLING: Ventilated
 DEFROSTING: Automatic
 POWER: 1240 Watt
 REFRIGERANT: R290
 THERMOSTAT: Electronic
 SHELVES: 5+5+5+5 adjustable

INFO

Castors
 Led illumination around the doors
 4 revolving doors
 Colour: black internal & external

7.900 € + V.A.T.

SUBZERO BEER COOLERS



SZB 380BL

SUBZERO BEER COOLER

DIMENSIONS: 615x610x1950 mm

TEMPERATURE: -5°C up to 3°C

CAPACITY: 350 lt

COOLING: Ventilated

DEFROSTING: Automatic

POWER: 300 Watt

REFRIGERANT: R600

THERMOSTAT: Electronic

SHELVES: 4 adjustable

INFO

Lock

Led illumination

Canopy illumination

Door opening left to right

Colour: white internal & black external

1.490 € + V.A.T.

NEW

SZB 490BL

SUBZERO BEER COOLER

DIMENSIONS: 655x685x1960 mm

TEMPERATURE: -5°C up to 3°C

CAPACITY: 455 lt

COOLING: Ventilated

DEFROSTING: Automatic

THERMOSTAT: Electronic

REFRIGERANT: R290

SHELVES: 4 adjustable + 1 at the bottom

INFO

Led illumination

Colour: white internal & black external

1.695 € + V.A.T.

NEW

DISPLAYS

WINE COOLERS



VW 60E

WINE COOLER

DIMENSIONS: 495x450x495 mm
TEMPERATURE: +6°C up to +18°C
CAPACITY: 45 lt / 13 bottles (750 ml)
COOLING: Static
DEFROSTING: Manual
POWER: 78 Watt
REFRIGERANT: R600a
THERMOSTAT: Electronic
SHELVES: 3 wooden (1+2)

INFO

Led illumination
«Frameless» door, opening left to right
Colour: black internal & external

645 € + V.A.T.



VW 110E

WINE COOLER

DIMENSIONS: 495x450x825 mm
TEMPERATURE: +6°C up to +18°C
CAPACITY: 95 lt / 32 bottles (750 ml)
COOLING: Static
DEFROSTING: Manual
POWER: 75 Watt
REFRIGERANT: R600a
THERMOSTAT: Electronic
SHELVES: 6 wooden (4+2)

INFO

Led illumination
«Frameless» door, opening left to right
Colour: black internal & external

845 € + V.A.T.



VW 500

FRAMELESS PANORAMIC WINE COOLER

DIMENSIONS: 656x656x1894 mm
TEMPERATURE: +5°C up to +18°C
CAPACITY: 400 lt / 81 bottles (750 ml)
POWER: 330 Watt
COOLING: Ventilated
DEFROSTING: Automatic
REFRIGERANT: R290
THERMOSTAT: Electronic
SHELVES: 9 chrome

INFO

4-side Led illumination
Colour: black with inox details

2.870 € + V.A.T.



VW 400

FRAMELESS WINE COOLER

DIMENSIONS: 600x630x1835 mm
TEMPERATURE: +6°C up to +14°C
CAPACITY: 342 lt / 103 bottles (750 ml)
COOLING: Static
DEFROSTING: Automatic
REFRIGERANT: R600
THERMOSTAT: Electronic
SHELVES: 7 wooden

INFO

Led illumination
Colour: black internal & external

1.420 € + V.A.T.



VW 400L/TOUCH

FRAMELESS WINE COOLER

DIMENSIONS: 575x530x1832mm
 CAPACITY: 352 lt / 101 bottles (750 ml)
 COOLING: Ventilated
 DEFROSTING: Automatic
 TEMPERATURE: +4°C up to +18°C
 THERMOSTAT: Electronic
 REFRIGERANT: R600a
 SHELVES: 7

INFO

«Frameless» door
 Control touch panel
 Horizontal and vertical Led illumination
 Led illumination around the doors (4 colours)
 Colour: black internal & external

1.890 € + V.A.T.

NEW



VW 450 DUAL/SS

2-ZONES WINE COOLER

DIMENSIONS: 595x540x1785 mm
 TEMPERATURE: +5°C up to +12°C
 & +12°C up to +22°C
 CAPACITY: 320 lt / 88 bottles (750 ml)
 POWER: 140 Watt
 COOLING: Static & auxiliary fan
 DEFROSTING: Automatic
 REFRIGERANT: R600
 THERMOSTAT: Electronic
 SHELVES: 14 wooden

INFO

Led illumination
 Colour: black internal & external

2.400 € + V.A.T.

DISPLAYS

BACK BAR COOLERS



BBC 210H-SS

BACK BAR COOLER

DIMENSIONS: 900x530x840 mm

TEMPERATURE: +2°C up to +8°C

CAPACITY: 518 lt

COOLING: Ventilated

DEFROSTING: Automatic

POWER: 150 Watt

REFRIGERANT: R600a

THERMOSTAT: Electronic

SHELVES: 2 adjustable

INFO

Internal Led illumination

Opening doors

Stainless steel construction

1.270 € + V.A.T.



BBC 310H-SS

BACK BAR COOLER

DIMENSIONS: 1350x530x840 mm

TEMPERATURE: +2°C up to +8°C

CAPACITY: 560 lt

COOLING: Ventilated

DEFROSTING: Automatic

POWER: 180 Watt

REFRIGERANT: R600a

THERMOSTAT: Electronic

SHELVES: 3 adjustable

INFO

Led illumination

Lock

Opening doors

1.595 € + V.A.T.

COOLING DISPLAYS



VF 55BT

COOLING DISPLAY

DIMENSIONS: 595x555x623 mm
TEMPERATURE: -18°C up to -22°C
CAPACITY: 55 lt
COOLING: Static
DEFROSTING: Manual
THERMOSTAT: Electronic
REFRIGERANT: R290
POWER: 155 Watt
SHELVES: 2 adjustable

INFO

Led illumination
Colour: white internal & black external

768 € + V.A.T.



VF 98BT

COOLING DISPLAY

DIMENSIONS: 595x555x842 mm
TEMPERATURE: -18°C up to -22°C
CAPACITY: 98 lt
COOLING: Static
DEFROSTING: Manual
THERMOSTAT: Electronic
REFRIGERANT: R290
POWER: 210 Watt
SHELVES: 3 adjustable

INFO

Led illumination
Colour: white internal & black external

1.075 € + V.A.T.

DISPLAYS

COOLING DISPLAYS

VFD 200SS G

COOLING DISPLAY

DIMENSIONS: 642x646x990 mm

TEMPERATURE: up to -18°C

SHELVES: 2

COOLING: Static

DEFROSTING: Automatic

POWER: 202 Watt

REFRIGERANT: R290

THERMOSTAT: Electronic

INFO

Lock

Led illumination

Stainless steel construction

1.160 € + V.A.T.

NEW



VFD 200SS

COOLING DISPLAY WITH INOX DOOR

DIMENSIONS: 642x646x990 mm

TEMPERATURE: up to -18°C

SHELVES: 2

COOLING: Static

DEFROSTING: Automatic

POWER: 202 Watt

REFRIGERANT: R290

THERMOSTAT: Electronic

INFO

Lock

Led illumination

Stainless steel construction

898 € + V.A.T.

NEW





VFG 400B

COOLING DISPLAY

DIMENSIONS: 600x585x1850 mm
TEMPERATURE: -15°C up to -22°C
CAPACITY: 326 lt
COOLING: Static
DEFROSTING: Manual
POWER: 384 Watt
REFRIGERANT: R290
THERMOSTAT: Electronic
SHELVES: 6 stable

INFO

Led illumination
Lock
Colour: white internal & black external

1.640 € + V.A.T.



DFV 550H

COOLING DISPLAY

DIMENSIONS: 620x765x2035 mm
TEMPERATURE: -15°C up to -22°C
CAPACITY: 450 lt
COOLING: Ventilated
DEFROSTING: Automatic
POWER: 650 Watt
REFRIGERANT: R290
THERMOSTAT: Electronic
SHELVES: 5 adjustable

INFO

Led illumination
Colour: white internal & black external

2.980 € + V.A.T.

DISPLAYS

COOLING DISPLAYS

DFV 1050H

COOLING DISPLAY

DIMENSIONS: 1250x765x2035 mm
TEMPERATURE: -15°C up to -22°C
CAPACITY: 990 lt
COOLING: Ventilated
DEFROSTING: Automatic
POWER: 1280 Watt
REFRIGERANT: R290
THERMOSTAT: Electronic
SHELVES: 5+5 adjustable

INFO

Led illumination
2 revolving doors
Colour: white internal & black external

4.340 € + V.A.T.



DFV 1500H

COOLING DISPLAY

DIMENSIONS: 1500x765x2035 mm
TEMPERATURE: -15°C up to -22°C
CAPACITY: 1540 lt
COOLING: Ventilated
DEFROSTING: Automatic
POWER: 1660 Watt
REFRIGERANT: R290
THERMOSTAT: Electronic
SHELVES: 5+5+5 adjustable

INFO

Led illumination
3 revolving doors
Colour: white internal & black external

6.900 € + V.A.T.



DFV 2050H

COOLING DISPLAY

DIMENSIONS: 2500x765x2035 mm
TEMPERATURE: -15°C up to -22°C
CAPACITY: 2080 lt
COOLING: Ventilated
DEFROSTING: Automatic
POWER: 2000 Watt
REFRIGERANT: R290
THERMOSTAT: Electronic
SHELVES: 5+5+5+5 adjustable

INFO

Led illumination
4 revolving doors
Colour: white internal & black external

9.500 € + V.A.T.

COUNTERTOP DISPLAYS



VE 60C

COUNTERTOP REFRIGERATED DISPLAY

DIMENSIONS: 456x410x819 mm
TEMPERATURE: 0°C up to +12°C
CAPACITY: 59 lt
COOLING: Ventilated
DEFROSTING: Automatic
REFRIGERANT: R290
THERMOSTAT: Electronic
SHELVES: 2 adjustable

INFO

Led illumination
Colour: white

635 € + V.A.T.



VE 60BL

COUNTERTOP REFRIGERATED DISPLAY

DIMENSIONS: 456x410x819 mm
TEMPERATURE: 0°C up to +12°C
CAPACITY: 59 lt
COOLING: Ventilated
DEFROSTING: Automatic
REFRIGERANT: R290
THERMOSTAT: Electronic
SHELVES: 2 adjustable

INFO

Led illumination
Colour: black

645 € + V.A.T.

DISPLAYS

COUNTERTOP DISPLAYS

VE 80BL

COUNTERTOP REFRIGERATED DISPLAY

DIMENSIONS: 456x410x969 mm
TEMPERATURE: 0°C up to +12°C
CAPACITY: 79 lt
COOLING: Ventilated
DEFROSTING: Automatic
REFRIGERANT: R290
THERMOSTAT: Electronic
SHELVES: 3 adjustable

INFO

Led illumination
Colour: black

695 € + V.A.T.



VE 80C

COUNTERTOP REFRIGERATED DISPLAY

DIMENSIONS: 456x410x969 mm
TEMPERATURE: 0°C up to +12°C
CAPACITY: 79 lt
COOLING: Ventilated
DEFROSTING: Automatic
REFRIGERANT: R290
THERMOSTAT: Electronic
SHELVES: 3 adjustable

INFO

Led illumination
Colour: white

685 € + V.A.T.





VE 109BL

COUNTERTOP COOLING DISPLAY

DIMENSIONS: 682x450x675 mm
TEMPERATURE: +2°C up to +10°C
CAPACITY: 100 lt
POWER: 190 Watt
COOLING: Ventilated
DEFROSTING: Automatic
REFRIGERANT: R290
THERMOSTAT: Electronic
SHELVES: 2 adjustable

INFO

Led illumination
Colour: black

840 € + V.A.T.



CVE 90DC

COUNTERTOP COOLING DISPLAY

DIMENSIONS: 900x560x790 mm
TEMPERATURE: +2°C up to +10°C
POWER: 180 Watt
COOLING: Ventilated
DEFROSTING: Automatic
REFRIGERANT: R290
THERMOSTAT: Electronic
SHELVES: 2

INFO

Led illumination
Sliding doors

1.870 € + V.A.T.

NEW

COUNTERTOP COOLING DISPLAYS



VE 345

COUNTERTOP COOLING DISPLAY

DIMENSIONS: 702x568x886 mm
 TEMPERATURE: +2°C up to +10°C
 CAPACITY: 145 lt
 POWER: 215 Watt
 COOLING: Ventilated
 DEFROSTING: Automatic
 REFRIGERANT: R290
 THERMOSTAT: Electronic
 SHELVES: 3 adjustable

INFO

Led illumination
 Colour: black
 Hot air extraction system at the front glass

1.280 € + V.A.T.



VE 346

COUNTERTOP COOLING DISPLAY

DIMENSIONS: 615x560x874 mm
 TEMPERATURE: +2°C up to +10°C
 CAPACITY: 146 lt
 POWER: 200 Watt
 COOLING: Ventilated
 DEFROSTING: Automatic
 REFRIGERANT: R290
 THERMOSTAT: Electronic
 SHELVES: 3 adjustable

INFO

Led illumination
 Colour: black
 Hot air extraction system at the sides and the front glass

1.400 € + V.A.T.



VE 395

COUNTERTOP COOLING DISPLAY

DIMENSIONS: 880x568x886 mm
 TEMPERATURE: +2°C up to +10°C
 CAPACITY: 195 lt
 POWER: 240 Watt
 COOLING: Ventilated
 DEFROSTING: Automatic
 REFRIGERANT: R290
 THERMOSTAT: Electronic
 SHELVES: 3 adjustable

INFO

Led illumination
 Colour: black
 Hot air extraction system at the front glass

1.350 € + V.A.T.



VE 396

COUNTERTOP COOLING DISPLAY

DIMENSIONS: 795x560x874 mm
 TEMPERATURE: +2°C up to +10°C
 CAPACITY: 196 lt
 POWER: 200 Watt
 COOLING: Ventilated
 DEFROSTING: Automatic
 REFRIGERANT: R290
 THERMOSTAT: Electronic
 SHELVES: 3 adjustable

INFO

Led illumination
 Colour: black
 Hot air extraction system at the sides and the front glass

1.490 € + V.A.T.



VE 120C

COUNTERTOP COOLING DISPLAY

DIMENSIONS: 702x568x686 mm
 TEMPERATURE: +2°C up to +10°C
 CAPACITY: 120 lt
 POWER: 215 Watt
 COOLING: Ventilated
 DEFROSTING: Automatic
 REFRIGERANT: R290
 THERMOSTAT: Electronic
 SHELVES: 2 adjustable

INFO

Led illumination
 Colour: black
 Hot air extraction system at the front glass

1.150 € + V.A.T.



VE 160C

COUNTERTOP COOLING DISPLAY

DIMENSIONS: 880x568x686 mm
 TEMPERATURE: +2°C up to +10°C
 CAPACITY: 160 lt
 COOLING: Ventilated
 POWER: 240 Watt
 DEFROSTING: Automatic
 REFRIGERANT: R290
 THERMOSTAT: Electronic
 SHELVES: 2 adjustable

INFO

Led illumination
 Colour: black
 Hot air extraction system at the front glass

1.240 € + V.A.T.



VE 200C

COUNTERTOP COOLING DISPLAY

DIMENSIONS: 1220x568x686 mm
 TEMPERATURE: +2°C up to +10°C
 CAPACITY: 200 lt
 COOLING: Ventilated
 POWER: 260 Watt
 DEFROSTING: Automatic
 REFRIGERANT: R290
 THERMOSTAT: Electronic
 SHELVES: 2 adjustable

INFO

Led illumination
 Colour: black
 Hot air extraction system at the front glass

1.680 € + V.A.T.



VE 250C

COUNTERTOP COOLING DISPLAY

DIMENSIONS: 1525x588x686 mm
 TEMPERATURE: +2°C up to +10°C
 CAPACITY: 265 lt
 POWER: 365 Watt
 COOLING: Ventilated
 DEFROSTING: Automatic
 REFRIGERANT: R290
 THERMOSTAT: Electronic
 SHELVES: 2 adjustable

INFO

Led illumination
 Colour: black
 Hot air extraction system at the front glass

1.895 € + V.A.T.



DISPLAYS

COUNTERTOP HEATED DISPLAYS



VE 120H

COUNTERTOP HEATED DISPLAY

DIMENSIONS: 678x568x686 mm
CAPACITY: 120 lt
TEMPERATURE: +30°C up to +90°C
POWER: 1100 Watt
THERMOSTAT: Analog
SHELVES: 3 adjustable

INFO

Led illumination
Colour: black

890 € + V.A.T.

VE 160H

COUNTERTOP HEATED DISPLAY

DIMENSIONS: 856x568x686 mm
CAPACITY: 160 lt
TEMPERATURE: +30°C up to +90°C
POWER: 1500 Watt
THERMOSTAT: Analog
SHELVES: 3 adjustable

INFO

Led illumination
Colour: black

960 € + V.A.T.



VE 200H

COUNTERTOP HEATED DISPLAY

DIMENSIONS: 1200x568x686 mm
CAPACITY: 200 lt
TEMPERATURE: +30°C up to +90°C
POWER: 1500 Watt
THERMOSTAT: Analog
SHELVES: 3 adjustable

INFO

Led illumination
Colour: black

1.290 € + V.A.T.



CVE 90DH

COUNTERTOP HEATED DISPLAY

DIMENSIONS: 900x560x790 mm
TEMPERATURE: +36°C up to +58°C
POWER: 280 Watt
THERMOSTAT: Electronic
SHELVES: 2

INFO

Led illumination
Sliding doors

1.460 € + V.A.T.

NEW

DISPLAYS

COUNTERTOP HEATED DISPLAYS

VE 50H

COUNTERTOP HEATED DISPLAY

DIMENSIONS: 554x361x376 mm
TEMPERATURE: +30°C up to +90°C
CAPACITY: 50 lt
POWER: 800 Watt
THERMOSTAT: Analog
SHELVES: 2 stable

INFO

Stainless steel construction

420 € + V.A.T.



VE 80HD

COUNTERTOP HEATED DISPLAY

DIMENSIONS: 700x400x376 mm
TEMPERATURE: +30°C up to +90°C
CAPACITY: 80 lt
POWER: 1 100 Watt
THERMOSTAT: Analog
SHELVES: 2 stable

INFO

Opening front & back doors
Door stabilisation system at lifted position

598 € + V.A.T.

NEW

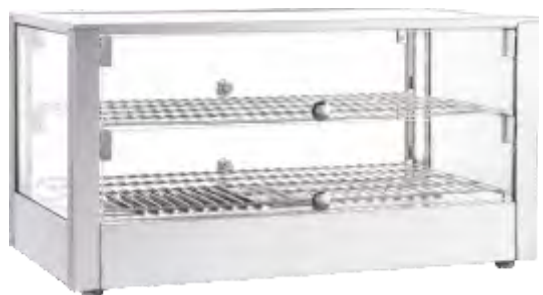



VHW 350B

COUNTERTOP HEATED DISPLAY

DIMENSIONS: 350x425x500 mm
POWER: 800 Watt
TEMPERATURE: +30°C up to +85°C
THERMOSTAT: Analog
SHELVES: 3

350 € + V.A.T.

NEW



VHW 827B

COUNTERTOP HEATED DISPLAY

DIMENSIONS: 660x466x610 mm
CAPACITY: 2 GN 1/1 - 65mm
POWER: 800 Watt
TEMPERATURE: +30°C up to +85°C
THERMOSTAT: Analog
SHELVES: 2

255 € + V.A.T.

NEW

DISPLAYS

COUNTERTOP DISPLAYS FOR GN 1/4 CONTAINERS



401234

COUNTERTOP DISPLAYS FOR GN 1/4 CONTAINERS

DIMENSIONS: 1200x335x435 mm
CAPACITY: 5 GN 1/4
POWER: 150 Watt
COOLING: Static
DEFROSTING: Automatic
REFRIGERANT: R290
TEMPERATURE: +2°C up to +10°C
THERMOSTAT: Electronic

INFO

Stainless steel
Containers are not included

775 € + V.A.T.

401534

COUNTERTOP DISPLAYS FOR GN 1/4 CONTAINERS

DIMENSIONS: 1500x335x435 mm
CAPACITY: 7 GN 1/4
POWER: 150 Watt
COOLING: Static
DEFROSTING: Automatic
REFRIGERANT: R290
TEMPERATURE: +2°C up to +10°C
THERMOSTAT: Electronic

INFO

Stainless steel
Containers are not included

915 € + V.A.T.

401434

COUNTERTOP DISPLAYS FOR GN 1/4 CONTAINERS

DIMENSIONS: 1400x335x435 mm
CAPACITY: 6 GN 1/4
POWER: 150 Watt
COOLING: Static
DEFROSTING: Automatic
REFRIGERANT: R290
TEMPERATURE: +2°C up to +10°C
THERMOSTAT: Electronic

INFO

Stainless steel
Containers are not included

860 € + V.A.T.

401834

COUNTERTOP DISPLAYS FOR GN 1/4 CONTAINERS

DIMENSIONS: 1800x335x435 mm
CAPACITY: 8 GN 1/4
POWER: 150 Watt
COOLING: Static
DEFROSTING: Automatic
REFRIGERANT: R290
TEMPERATURE: +2°C up to +10°C
THERMOSTAT: Electronic

INFO
Stainless steel
Containers are not included

980 € + V.A.T.

401634

COUNTERTOP DISPLAYS FOR GN 1/4 CONTAINERS

DIMENSIONS: 1600x335x435 mm
CAPACITY: 7 GN 1/4
POWER: 150 Watt
COOLING: Static
DEFROSTING: Automatic
REFRIGERANT: R290
TEMPERATURE: +2°C up to +10°C
THERMOSTAT: Electronic

INFO
Stainless steel
Containers are not included

935 € + V.A.T.

402034

COUNTERTOP DISPLAYS FOR GN 1/4 CONTAINERS

DIMENSIONS: 2000x335x435 mm
CAPACITY: 10 GN 1/4
POWER: 150 Watt
COOLING: Static
DEFROSTING: Automatic
REFRIGERANT: R290
TEMPERATURE: +2°C up to +10°C
THERMOSTAT: Electronic

INFO
Stainless steel
Containers are not included

1.015 € + V.A.T.

DISPLAYS

COUNTERTOP DISPLAYS FOR GN 1/3 CONTAINERS



401238

COUNTERTOP DISPLAYS FOR GN 1/3 CONTAINERS

DIMENSIONS: 1200x395x435 mm
CAPACITY: 4 GN 1/3
POWER: 150 Watt
COOLING: Static
DEFROSTING: Automatic
REFRIGERANT: R290
TEMPERATURE: +2°C up to +10°C
THERMOSTAT: Electronic

INFO

Stainless steel
Containers are not included

825 € + V.A.T.

401538

COUNTERTOP DISPLAYS FOR GN 1/3 CONTAINERS

DIMENSIONS: 1500x395x435 mm
CAPACITY: 6 GN 1/3
POWER: 150 Watt
COOLING: Static
DEFROSTING: Automatic
REFRIGERANT: R290
TEMPERATURE: +2°C up to +10°C
THERMOSTAT: Electronic

INFO

Stainless steel
Containers are not included

935 € + V.A.T.

401438

COUNTERTOP DISPLAYS FOR GN 1/3 CONTAINERS

DIMENSIONS: 1400x395x435 mm
CAPACITY: 6 GN 1/3
POWER: 150 Watt
COOLING: Static
DEFROSTING: Automatic
REFRIGERANT: R290
TEMPERATURE: +2°C up to +10°C
THERMOSTAT: Electronic

INFO

Stainless steel
Containers are not included

905 € + V.A.T.

401838

COUNTERTOP DISPLAYS FOR GN 1/3 CONTAINERS

DIMENSIONS: 1800x395x435 mm
CAPACITY: 8 GN 1/3
POWER: 150 Watt
COOLING: Static
DEFROSTING: Automatic
REFRIGERANT: R290
TEMPERATURE: +2°C up to +10°C
THERMOSTAT: Electronic

INFO
Stainless steel
Containers are not included

1.025 € + V.A.T.

401638

COUNTERTOP DISPLAYS FOR GN 1/3 CONTAINERS

DIMENSIONS: 1600x395x435 mm
CAPACITY: 7 GN 1/3
POWER: 150 Watt
COOLING: Static
DEFROSTING: Automatic
REFRIGERANT: R290
TEMPERATURE: +2°C up to +10°C
THERMOSTAT: Electronic

INFO
Stainless steel
Containers are not included

970 € + V.A.T.

402038

COUNTERTOP DISPLAYS FOR GN 1/3 CONTAINERS

DIMENSIONS: 2000x395x435 mm
CAPACITY: 9 GN 1/3
POWER: 150 Watt
COOLING: Static
DEFROSTING: Automatic
REFRIGERANT: R290
TEMPERATURE: +2°C up to +10°C
THERMOSTAT: Electronic

INFO
Stainless steel
Containers are not included

1.075 € + V.A.T.

DISPLAYS

NEUTRAL DISPLAYS



VE 65N

NEUTRAL DISPLAY

DIMENSIONS: 550x398x381 mm
CAPACITY: 65 lt

INFO

Sliding back doors
Glass shelf
Black details

315 € + V.A.T.

NEW

VE 90N

NEUTRAL DISPLAY

DIMENSIONS: 827x368x366 mm
CAPACITY: 90 lt

INFO

Sliding back doors
Glass shelf
Black details

398 € + V.A.T.

NEW



VE 120N

NEUTRAL DISPLAY

DIMENSIONS: 920x398x381 mm
CAPACITY: 120 lt

INFO

Sliding back doors
Glass shelf
Black details

495 € + V.A.T.

NEW



VE 70N

NEUTRAL DISPLAYS

DIMENSIONS: 360x605x515 mm
CAPACITY: 70 lt

INFO

Stainless steel & glass

315 € + V.A.T.

REFRIGERATED DISPLAYS



HBS 90

REFRIGERATED DISPLAY

DIMENSIONS: 900x700x1200 mm
CAPACITY: 300 lt
POWER: 450 Watt
COOLING: Ventilated
DEFROSTING: Automatic
REFRIGERANT: R290/R134
TEMPERATURE: +2°C up to +10°C
THERMOSTAT: Electronic
SHELVES: 2

INFO

Sliding doors
Upper & shelves' Led illumination
Colour: Black
Antifog film

3.070 € + V.A.T.

HBS 120

REFRIGERATED DISPLAY

DIMENSIONS: 1200x700x1200 mm
CAPACITY: 415 lt
POWER: 550 Watt
COOLING: Ventilated
DEFROSTING: Automatic
REFRIGERANT: R290/R134
TEMPERATURE: +2°C up to +10°C
THERMOSTAT: Electronic
SHELVES: 2

INFO

Sliding doors
Upper & shelves' Led illumination
Colour: Black
Antifog film

3.270 € + V.A.T.

HBS 150

REFRIGERATED DISPLAY

DIMENSIONS: 1500x700x1200 mm
CAPACITY: 525lt
POWER: 650 Watt
COOLING: Ventilated
DEFROSTING: Automatic
REFRIGERANT: R290/R134
TEMPERATURE: +2°C up to +10°C
THERMOSTAT: Electronic
SHELVES: 2

INFO

Sliding doors
Upper & shelves' Led illumination
Colour: Black
Antifog film

3.460 € + V.A.T.

REFRIGERATED DISPLAYS

HBS 9003SL**REFRIGERATED DISPLAY**

DIMENSIONS: 900x685x1300 mm
 SHELF DIMENSIONS: 790x400 mm
 CAPACITY: 487 lt
 POWER: 530 Watt
 COOLING: Ventilated
 DEFROSTING: Automatic
 REFRIGERANT: R290
 TEMPERATURE: +2°C up to +10°C
 THERMOSTAT: Electronic
 SHELVES: 3

INFO

Sliding doors
 Antifog film
 Dixell digital controller

3.150 € + V.A.T.**NEW****HBS 12003SL****REFRIGERATED DISPLAY**

DIMENSIONS: 1200x685x1300 mm
 SHELF DIMENSIONS: 1090x400 mm
 CAPACITY: 670 lt
 POWER: 720 Watt
 COOLING: Ventilated
 DEFROSTING: Automatic
 REFRIGERANT: R290
 TEMPERATURE: +2°C up to +10°C
 THERMOSTAT: Electronic
 SHELVES: 3

INFO

Sliding doors
 Antifog film
 Dixell digital controller

3.300 € + V.A.T.**NEW****HBS 15003SL****REFRIGERATED DISPLAY**

DIMENSIONS: 1500x685x1300 mm
 SHELF DIMENSIONS: 1390x400 mm
 CAPACITY: 890 lt
 POWER: 530 Watt
 COOLING: Ventilated
 DEFROSTING: Automatic
 REFRIGERANT: R290
 TEMPERATURE: +2°C up to +10°C
 THERMOSTAT: Electronic
 SHELVES: 3

INFO

Sliding doors
 Antifog film
 Dixell digital controller

3.598 € + V.A.T.**NEW**



CBS 90

REFRIGERATED HEATED DISPLAY

DIMENSIONS: 900x700x1220 mm
CAPACITY: 300 lt
POWER: 1200 Watt
TEMPERATURE: +30°C up to +70°C
THERMOSTAT: Electronic
SHELVES: 2

INFO

Sliding doors
Upper & shelves' Led illumination
Colour: black

1.850 € + V.A.T.



CBS 120

REFRIGERATED HEATED DISPLAY

DIMENSIONS: 1200x700x1220 mm
CAPACITY: 415 lt
POWER: 1600 Watt
TEMPERATURE: +30°C up to +70°C
THERMOSTAT: Electronic
SHELVES: 2

INFO

Sliding doors
Upper & shelves' Led illumination
Colour: black

2.075 € + V.A.T.

CBS 150

REFRIGERATED HEATED DISPLAY

DIMENSIONS: 1500x700x1200 mm
CAPACITY: 528 lt
POWER: 2200 Watt
TEMPERATURE: +30°C up to +70°C
THERMOSTAT: Electronic
SHELVES: 2

INFO

Sliding doors
Upper & shelves' Led illumination
Colour: black

2.185 € + V.A.T.

 All CBS & HBS refrigerated displays are also available in white colour.

DISPLAYS

REFRIGERATED DISPLAYS

CBS 9003SL

REFRIGERATED HEATED DISPLAY

DIMENSIONS: 900x685x1300 mm
SHELF DIMENSIONS: 790x400 mm
CAPACITY: 487 lt
POWER: 485 Watt
TEMPERATURE: +30°C up to +70°C
THERMOSTAT: Electronic
SHELVES: 3

INFO

Sliding doors
Dixell digital controller

1.900 € + V.A.T.

NEW



CBS 12003SL

REFRIGERATED HEATED DISPLAY

DIMENSIONS: 1200x685x1300 mm
SHELF DIMENSIONS: 1090x400 mm
CAPACITY: 670 lt
POWER: 7300 Watt
TEMPERATURE: +30°C up to +70°C
THERMOSTAT: Electronic
SHELVES: 3

INFO

Sliding doors
Dixell digital controller

2.150 € + V.A.T.

NEW





VE 280 BL

PANORAMIC REFRIGERATED DISPLAY

DIMENSIONS: 562x532x1905 mm
CAPACITY: 270 lt
COOLING: Ventilated
DEFROSTING: Automatic
POWER: 350 Watt
TEMPERATURE: 0°C up to +12°C
THERMOSTAT: Electronic
SHELVES: 5 adjustable

INFO

Led illumination
Colour: black

1.460 € + V.A.T.

DISPLAYS

ICE CREAM DISPLAYS

SDF 150G

ICE CREAM DISPLAY

DIMENSIONS EXT.: 665x715x875 mm
DIMENSIONS INT.: 515x540x647 mm
CAPACITY: 120 lt
POWER: 260 Watt - 230 V
TEMPERATURE: -25°C
THERMOSTAT: Analog
COOLING: Static
REFRIGERANT: R290

INFO
Castors

1.295 € + V.A.T.

SDF 360G

ICE CREAM DISPLAY

DIMENSIONS EXT.: 1260x715x875 mm
DIMENSIONS INT.: 1110x540x647 mm
CAPACITY: 290 lt
POWER: 350 Watt - 230 V
TEMPERATURE: -25°C
THERMOSTAT: Analog
COOLING: Static
REFRIGERANT: R290

INFO
Castors

1.870 € + V.A.T.

SDF 460G

ICE CREAM DISPLAY

DIMENSIONS EXT.: 1530x715x875 mm
DIMENSIONS INT.: 1380x540x647 mm
CAPACITY: 370 lt
POWER: 520 Watt - 230 V
TEMPERATURE: -25°C
THERMOSTAT: Analog
COOLING: Static
REFRIGERANT: R290

INFO
Castors

2.145 € + V.A.T.

SDF 260G

ICE CREAM DISPLAY

DIMENSIONS EXT.: 990x715x875 mm
DIMENSIONS INT.: 840x540x647 mm
CAPACITY: 210 lt
POWER: 300 Watt - 230 V
TEMPERATURE: -25°C
THERMOSTAT: Analog
COOLING: Static
REFRIGERANT: R290

INFO
Castors

1.415 € + V.A.T.



SDF 560G

ICE CREAM DISPLAY

DIMENSIONS EXT.: 1800x715x875 mm
DIMENSIONS INT.: 1650x540x647 mm
CAPACITY: 450 lt
POWER: 580 Watt - 230 V
TEMPERATURE: -25°C
THERMOSTAT: Analog
COOLING: Static
REFRIGERANT: R290

INFO
Castors

2.635 € + V.A.T.



IC 10

ICE CREAM DISPLAY

DIMENSIONS: 1410x850x1300 mm
CAPACITY: 10 containers (360x165x120mm)
POWER: 1500 Watt
COOLING: Ventilated
DEFROSTING: Automatic
TEMPERATURE: -18°C up to -22°C
THERMOSTAT: Electronic

INFO

Sliding back doors
Internal electronic thermometer
Led illumination
Curved glass

6.790 € + V.A.T.



IC 10S

ICE CREAM DISPLAY

DIMENSIONS: 1410x850x1300 mm
CAPACITY: 10 containers (360x165x120 mm)
POWER: 1500 Watt
COOLING: Ventilated
DEFROSTING: Automatic
TEMPERATURE: -18°C up to -22°C
THERMOSTAT: Electronic

INFO

Sliding back doors
Internal electronic thermometer
Led illumination
Flat glass

6.890 € + V.A.T.



IC 10BLS

ICE CREAM DISPLAY

DIMENSIONS: 1410x850x1300 mm
CAPACITY: 10 containers (360x165x120 mm)
POWER: 1500 Watt
COOLING: Ventilated
DEFROSTING: Automatic
TEMPERATURE: -18°C up to -22°C
THERMOSTAT: Electronic

INFO

Sliding back doors
Internal electronic thermometer
Led illumination
Flat glass
Colour: black internal & external

6.980 € + V.A.T.

NEW

DISPLAYS

MEAT DISPLAYS WITH FLAT GLASS



MC 1500

MEAT DISPLAY

DIMENSIONS: 1500x1180x1230 mm
CAPACITY: 230 lt
POWER: 850 Watt - 220 V - 50 Hz
TEMPERATURE: 1°C up to 10°C
THERMOSTAT: Electronic
COOLING: Ventilated
DEFROSTING: Automatic
REFRIGERANT: R290

INFO

Castors
Led illumination
Digital control panel
Built-in motor

4.890 € + V.A.T.

NEW

MC 2000

MEAT DISPLAY

DIMENSIONS: 2000x1180x1230 mm
CAPACITY: 300 lt
POWER: 1100 Watt - 220 V - 50 Hz
TEMPERATURE: 1°C up to 10°C
THERMOSTAT: Electronic
COOLING: Ventilated
DEFROSTING: Automatic
REFRIGERANT: R290

INFO

Castors
Led illumination
Digital control panel
Built-in motor

5.495 € + V.A.T.

NEW

MC 2500

MEAT DISPLAY

DIMENSIONS: 2500x1180x1230 mm
CAPACITY: 380 lt
POWER: 1280 Watt - 220 V - 50 Hz
TEMPERATURE: 1°C up to 10°C
THERMOSTAT: Electronic
COOLING: Ventilated
DEFROSTING: Automatic
REFRIGERANT: R290

INFO

Castors
Led illumination
Digital control panel
Built-in motor

6.790 € + V.A.T.

NEW

MEAT DISPLAYS WITH CURVED GLASS



ECMC 1500

MEAT DISPLAY

DIMENSIONS: 1500x1180x1230 mm
CAPACITY: 230 lt
POWER: 850 Watt - 220 V - 50 Hz
TEMPERATURE: 1°C up to 10°C
THERMOSTAT: Electronic
COOLING: Ventilated
DEFROSTING: Automatic
REFRIGERANT: R290

INFO

Castors
Led illumination
Digital control panel
Built-in motor

4.680 € + V.A.T.

NEW

ECMC 2000

MEAT DISPLAY

DIMENSIONS: 2000x1180x1230 mm
CAPACITY: 300 lt
POWER: 1100 Watt - 220 V - 50 Hz
TEMPERATURE: 1°C up to 10°C
THERMOSTAT: Electronic
COOLING: Ventilated
DEFROSTING: Automatic
REFRIGERANT: R290

INFO

Castors
Led illumination
Digital control panel
Built-in motor

4.950 € + V.A.T.

NEW

MC 2500

MEAT DISPLAY

DIMENSIONS: 2500x1180x1230 mm
CAPACITY: 380 lt
POWER: 1280 Watt - 220 V - 50 Hz
TEMPERATURE: 1°C up to 10°C
THERMOSTAT: Electronic
COOLING: Ventilated
DEFROSTING: Automatic
REFRIGERANT: R290

INFO

Castors
Led illumination
Digital control panel
Built-in motor

6.450 € + V.A.T.

NEW

MC 3000

MEAT DISPLAY

DIMENSIONS: 3000x1180x1230 mm
CAPACITY: 470 lt
POWER: 1400 Watt - 220 V - 50 Hz
TEMPERATURE: 1°C up to 10°C
THERMOSTAT: Electronic
COOLING: Ventilated
DEFROSTING: Automatic
REFRIGERANT: R290

INFO

Castors
Led illumination
Digital control panel
Built-in motor

8.690 € + V.A.T.

NEW

DISPLAYS

SELF SERVICE DISPLAYS





03

FREEZERS



Freezers

CHEST FREEZERS [82]

FLAT SLIDING GLASS LID FREEZERS [86]

CURVED SLIDING GLASS LID FREEZERS [88]

VERTICAL FREEZERS [89]

ISLAND CHEST FREEZERS [90]

FREEZERS

CHEST FREEZERS

ES 110 BLACK / DUAL

DUAL TEMPERATURE CHEST FREEZER

DIMENSIONS: 635x580x800 mm
CAPACITY: 100 lt
TEMPERATURE: +8°C up to -20°C
COOLING: Static
DEFROST: Manual
REFRIGERANT: R600a
THERMOSTAT: Electronic
COLOUR: Black

INFO

Climate class N/ST
Led illumination around the glass
Castors

630 € + V.A.T.



ES 130

CHEST FREEZER

DIMENSIONS EXT.: 515x550x845mm
CAPACITY: 98 lt
TEMPERATURE: -18°C up to -25°C
POWER: 74 Watt
DEFROST: Manual
REFRIGERANT: R600a
THERMOSTAT: Analog
COLOUR: White

INFO

Climate class Sub-Tropical

280 € + V.A.T.

NEW



ES 150

CHEST FREEZER

DIMENSIONS EXT. : 545x610x830 mm
DIMENSIONS INT.: 434x414x682 mm
CAPACITY: 100 lt
TEMPERATURE: -18°C up to -25°C
POWER: 95 Watt
DEFROST: Manual
REFRIGERANT: R600a
THERMOSTAT: Analog
COLOUR: White

INFO

Climate class Tropical
Illumination
Castors
Lock

335 € + V.A.T.



ES 241

CHEST FREEZER

DIMENSIONS EXT.: 720x678x830 mm
DIMENSIONS INT.: 600x480x692 mm
CAPACITY: 197 lt
TEMPERATURE: -18°C up to -25°C
POWER: 120 Watt
DEFROST: Manual
REFRIGERANT: R600a
THERMOSTAT: Analog
COLOUR: White

INFO

Climate class Tropical
Illumination
Castors
Lock

415 € + V.A.T.

ES 270

CHEST FREEZER

DIMENSIONS: 834x678x830 mm
CAPACITY: 227 lt
TEMPERATURE: -18°C up to -25°C
POWER: 120 Watt
DEFROST: Manual
REFRIGERANT: R600a
THERMOSTAT: Analog
COLOUR: Gray

INFO

Climate class Sub-Tropical
Led illumination
Castors
Lock

430 € + V.A.T.

ES 295

CHEST FREEZER

DIMENSIONS EXT.: 985x560x830 mm
DIMENSIONS INT.: 874x405x683 mm
CAPACITY: 240 lt
TEMPERATURE: -18°C up to -25°C
POWER: 125 Watt
DEFROST: Manual
REFRIGERANT: R600a
THERMOSTAT: Analog
COLOUR: White

INFO

Climate class Tropical
Illumination
Castors
Lock

480 € + V.A.T.



FREEZERS

CHEST FREEZERS

ES 370

CHEST FREEZER

DIMENSIONS EXT.: 1116x644x845mm
CAPACITY: 282 lt
TEMPERATURE: -18°C up to -25°C
POWER: 112 Watt
DEFROST: Manual
REFRIGERANT: R600a
THERMOSTAT: Analog
COLOUR: White

INFO

Climate class: Sub-Tropical
Castors

485 € + V.A.T.

NEW



ES 491

CHEST FREEZER

DIMENSIONS EXT.: 1480x670x830 mm
DIMENSIONS INT.: 1342x480x675 mm
CAPACITY: 423 lt
TEMPERATURE: -18°C up to -25°C
POWER: 223 Watt
DEFROST: Manual
REFRIGERANT: R290
THERMOSTAT: Analog
COLOUR: White

INFO

Climate class Tropical
Illumination
Castors
Lock

755 € + V.A.T.



ES 491 LUX

CHEST FREEZER

DIMENSIONS EXT.: 1480x670x830 mm
DIMENSIONS INT.: 1342x480x675 mm
CAPACITY: 423 lt
TEMPERATURE: -18°C up to -25°C
POWER: 223 Watt
DEFROST: Manual
REFRIGERANT: R290
THERMOSTAT: Analog
COLOUR: Gray

INFO

Climate class Tropical
Illumination
Castors
Lock

775 € + V.A.T.

NEW





ES 690

CHEST FREEZER

DIMENSIONS: 1800x760x827 mm
CAPACITY: 600 lt
TEMPERATURE: -18°C up to -25°C
POWER: 270 Watt
DEFROST: Manual
REFRIGERANT: R290
THERMOSTAT: Analog
COLOUR: Gray

INFO

Climate class Sub-Tropical
Led illumination
Castors
Lock

965 € + V.A.T.



ES 790

CHEST FREEZER

DIMENSIONS EXT.: 1945x797x825 mm
DIMENSIONS INT.: 1805x615x615 mm
CAPACITY: 750 lt
TEMPERATURE: -18°C up to -25°C
POWER: 450 Watt
DEFROST: Manual
REFRIGERANT: R290
THERMOSTAT: Analog
COLOUR: Gray

INFO

Climate class ST
Illumination
Castors
Lock

1.350 € + V.A.T.

FREEZERS

LID FREEZERS WITH SLIDING GLASS

SDF 140

FLAT SLIDING GLASS LID FREEZER

DIMENSIONS: 620x510x830mm
CAPACITY: 100 lt
COOLING: Static
DEFROST: Manual
REFRIGERANT: R600a
TEMPERATURE: -18°C
THERMOSTAT: Analog
SLIDING GLASSES: 2
BASKETS: 2 (not included)
COLOUR: White

INFO

Climate class N
Castors

545 € + V.A.T.



SDF 230

FLAT SLIDING GLASS LID FREEZER

DIMENSIONS: 990x545x784mm
CAPACITY: 205 lt
COOLING: Static
DEFROST: Manual
REFRIGERANT: R600a
TEMPERATURE: -18°C
THERMOSTAT: Analog
SLIDING GLASSES: 2
BASKETS: 3 (not included)
COLOUR: White

INFO

Climate class N
Castors

695 € + V.A.T.





SDF 320

FLAT SLIDING GLASS LID FREEZER

DIMENSIONS: 1165x605x784mm
CAPACITY: 288 lt
COOLING: Static
DEFROST: Manual
REFRIGERANT: R290
TEMPERATURE: -18°C
THERMOSTAT: Analog
SLIDING GLASSES: 2
BASKETS: 4 (not included)
COLOUR: White

INFO

Climate class N
Castors

835 € + V.A.T.

SDF 550

FLAT SLIDING GLASS LID FREEZER

DIMENSIONS: 1688x675x782mm
CAPACITY: 469 lt
COOLING: Static
DEFROST: Manual
REFRIGERANT: R290
TEMPERATURE: -18°C
THERMOSTAT: Analog
SLIDING GLASSES: 2
BASKETS: 5 (not included)
COLOUR: White

INFO

Climate class N
Castors

1.165 € + V.A.T.

LID FREEZERS WITH SLIDING GLASS



SDC 450

CURVED SLIDING GLASS LID FREEZER

DIMENSIONS EXT.: 1270x680x850 mm
CAPACITY: 380 lt
TEMPERATURE: -18°C up to -20°C
COOLING: Static
DEFROST: Manual
REFRIGERANT: R290
THERMOSTAT: Electronic
BASKETS: 4

INFO

Castors
Digital temperature indicator
Lock
Led illumination

1.090 € + V.A.T.

NEW

SDC 550

CURVED SLIDING GLASS LID FREEZER

DIMENSIONS EXT.: 1475x757x858 mm
CAPACITY: 500 lt
TEMPERATURE: -18°C up to -20°C
COOLING: Static
REFRIGERANT: R290
POWER: 400 Watt
THERMOSTAT: Electronic
BASKETS: 4

INFO

Castors
Climate class ST
Digital temperature indicator
Led illumination
Insulation 75 mm

1.550 € + V.A.T.

SDC 650

CURVED SLIDING GLASS LID FREEZER

DIMENSIONS EXT.: 1810x680x850 mm
CAPACITY: 440 lt
TEMPERATURE: -18°C up to -20°C
COOLING: Static
DEFROST: Manual
REFRIGERANT: R290
POWER: 420 Watt
THERMOSTAT: Electronic

INFO

Castors
Digital temperature indicator
Led illumination

1.280 € + V.A.T.

NEW

SDC 750

CURVED SLIDING GLASS LID FREEZER

DIMENSIONS EXT.: 2000x757x858 mm
CAPACITY: 700 lt
TEMPERATURE: -18°C up to -20°C
COOLING: Static
REFRIGERANT: R290
POWER: 530 Watt
THERMOSTAT: Electronic
BASKETS: 6

INFO

Castors
Climate class ST
Digital temperature indicator
Led illumination
Insulation 75 mm

1.995 € + V.A.T.

VERTICAL FREEZERS



VF 130 BLACK

VERTICAL FREEZER WITH DRAWERS

DIMENSIONS: 550x546x833 mm
CAPACITY: 100 lt
TEMPERATURE: -25°C
POWER: 95 Watt
COOLING: Static
DEFROST: Manual
REFRIGERANT: R600a
THERMOSTAT: Analog
DRAWERS: 3

INFO

Climate class Sub-Tropical
Colour: White internal & black external

415 € + V.A.T.



VF 310 BLACK

VERTICAL FREEZER WITH DRAWERS

DIMENSIONS: 600x620x1690 mm
CAPACITY: 310 lt
TEMPERATURE: -25°C
POWER: 130 Watt
COOLING: Static
DEFROST: Manual
REFRIGERANT: R600a
THERMOSTAT: Analog
DRAWERS: 7

INFO

Climate class Sub-Tropical
Colour: White internal & black external

720 € + V.A.T.

FREEZERS

ISLAND CHEST FREEZERS



SDC 550/ADF

CURVED SLIDING GLASS ISLAND CHEST FREEZER

DIMENSIONS: 1500x850x850 mm
CAPACITY: 550 lt
TEMPERATURE: -18°C up to -20°C
COOLING: Static
DEFROST: Automatic (hot gas)
REFRIGERANT: R290
POWER: 600 Watt
THERMOSTAT: Electronic

INFO

Castors
Lock
Climate class 4/L1
Insulation 75 mm
Led illumination

2.710 € + V.A.T.

SDC 750/ADF

«HEADER» CURVED SLIDING GLASS ISLAND CHEST FREEZER

DIMENSIONS: 1900x850x850 mm
CAPACITY: 750 lt
TEMPERATURE: -18°C up to -20°C
COOLING: Static
DEFROST: Automatic (hot gas)
REFRIGERANT: R290
POWER: 700 Watt
THERMOSTAT: Electronic

INFO

Castors
Lock
Climate class 4/L1
Insulation 75 mm
Led illumination

2.035 € + V.A.T.





SDC 800/ADF

CURVED SLIDING GLASS ISLAND CHEST FREEZER

DIMENSIONS: 2000x850x850 mm
 CAPACITY: 800 lt
 TEMPERATURE: -18°C up to -20°C
 COOLING: Static
 DEFROST: Automatic (hot gas)
 REFRIGERANT: R290
 POWER: 700 Watt
 THERMOSTAT: Electronic

INFO

Castors
 Lock
 Climate class 4/L1
 Insulation 75 mm
 Led illumination

2.695 € + V.A.T.

SDC 1000/ADF

CURVED SLIDING GLASS ISLAND CHEST FREEZER

DIMENSIONS: 2500x850x850 mm
 CAPACITY: 1000 lt
 TEMPERATURE: -18°C up to -20°C
 COOLING: Static
 DEFROST: Automatic (hot gas)
 REFRIGERANT: R290
 POWER: 800 Watt
 THERMOSTAT: Electronic

INFO

Castors
 Lock
 Climate class 4/L1
 Insulation 75 mm
 Led illumination

3.070 € + V.A.T.



04

COOKING

Ovens

CONVECTION ELECTRIC OVENS [94]

COMBI STEAM OVENS [99]

PROVERS [102]

TRAYS [103]

GRILLS [104]

OVEN CLEANERS [105]

PIZZA OVENS [106]



BC 433 1**CONVECTION ELECTRIC OVEN
ANALOG**

DIMENSIONS EXT.: 595x530x570 mm

DIMENSIONS INT.: 370x480x370 mm

CAPACITY: 4 trays (435x315 mm)

POWER: 2.67 kW / 220 V

TEMPERATURE: 50°C up to 300°C

FANS: 2 non auto-reverse rotation

INFO

Stainless steel

Timer

Trays included

720 € + V.A.T.**NEW****BC 433 1H****CONVECTION ELECTRIC OVEN
ANALOG**

DIMENSIONS EXT.: 595x530x570 mm

DIMENSIONS INT.: 370x480x370 mm

CAPACITY: 4 trays (435x315 mm)

POWER: 2.67 kW / 220 V

TEMPERATURE: 50°C up to 300°C

FANS: 2 non auto-reverse rotation

INFO

Humidity injection

Stainless steel

Timer

Trays included

760 € + V.A.T.**NEW**

ON 0464MH

CONVECTION ELECTRIC OVEN ANALOG

DIMENSIONS: 725x650x560 mm
CAPACITY: 4 trays 40x60 cm
SPACE BETWEEN TRAYS: 80 mm
POWER: 5.5 kW / 400V
TEMPERATURE: 50°C up to 270°C
FANS: 2 non auto-reverse rotation

INFO

Stainless steel
Humidity injection
Trays not included

1.690 € + V.A.T.



OS 0464M

CONVECTION ELECTRIC OVEN ANALOG

DIMENSIONS: 765x690x585 mm
CAPACITY: 4 trays 40x60 cm & GN1/1
SPACE BETWEEN TRAYS: 80 mm
POWER: 6.1 kW / 400V
TEMPERATURE: 50°C up to 270°C
FANS: 1 big auto-reverse rotation

INFO

Stainless steel
Humidity injection
Trays not included

2.280 € + V.A.T.



OVENS

CONVECTION ELECTRIC OVENS

OV 433G

CONVECTION ELECTRIC OVEN ANALOG

DIMENSIONS EXT.: 590x675x585 mm
CAPACITY: 4 trays (435x315 mm)
POWER: 3.1 Kw + 1.7 kW / 220 V
TEMPERATURE: 30°C up to 280°C
FANS: 2 non auto-reverse rotation

INFO

Grill 1.7 kW
Stainless steel
Timer
Trays included

1.198 € + V.A.T.

NEW



OV 533GN

CONVECTION ELECTRIC OVEN ANALOG

DIMENSIONS EXT.: 685x665x585 mm
SPACE BETWEEN TRAYS: 8 cm
CAPACITY: 4 GN 1/1
POWER: 4 Kw / 220 V
TEMPERATURE: 30°C up to 280°C
FANS: 2 non auto-reverse rotation

INFO

Stainless steel
Timer

1.265 € + V.A.T.

NEW



OV 6043

CONVECTION ELECTRIC OVEN ANALOG

DIMENSIONS EXT.: 770x725x560 mm
CAPACITY: 3 trays 60x40 cm or GN 1/1
POWER: 4 Kw / 220 V
TEMPERATURE: 30°C up to 280°C
FANS: 2 non auto-reverse rotation

INFO

Stainless steel
Timer
Trays not included

1.300 € + V.A.T.

NEW

OV 6044H

CONVECTION ELECTRIC OVEN ANALOG

DIMENSIONS EXT.: 770x725x665 mm
CAPACITY: 4 trays 60x40 cm or GN 1/1
POWER: 4 kW / 220 V
TEMPERATURE: 30°C up to 280°C
FANS: 2 non auto-reverse rotation

INFO
Humidity injection
Stainless steel
Timer
Trays not included

1.470 € + V.A.T.

NEW

OV 6044HG

CONVECTION ELECTRIC OVEN ANALOG

DIMENSIONS EXT.: 590x675x585 mm
CAPACITY: 4 trays 60x40 cm & GN 1/1
POWER: 6.3 Kw + 1.7 kW / 400 V
TEMPERATURE: 30°C up to 280°C
FANS: 2 non auto-reverse rotation

INFO
Humidity injection
Grill 1.7kW
Stainless steel
Timer
Trays not included

1.795 € + V.A.T.

NEW

OV 644GN

CONVECTION ELECTRIC OVEN ANALOG

DIMENSIONS EXT.: 840x910x830 mm
CAPACITY: 6 GN 1/1 or trays 40x60 cm
POWER: 7.9 kW / 400 V
TEMPERATURE: 30°C up to 280°C
FANS: 2 auto-reverse rotation

INFO
Humidity injection
Stainless steel
Timer

3.790 € + V.A.T.

NEW

OV 1064GN

CONVECTION ELECTRIC OVEN ANALOG

DIMENSIONS EXT.: 840x910x1150 mm
CAPACITY: 10 GN 1/1 or trays 40x60 cm
POWER: 12.95 kW / 400 V
TEMPERATURE: 30°C up to 280°C
FANS: 3 auto-reverse rotation

INFO
Humidity injection
Stainless steel
Timer

4.650 € + V.A.T.

NEW

OVENS

COMBI STEAM OVENS



100% MADE IN ITALY

OV 0611D

COMBI STEAMER OVEN WASH

DIMENSIONS: 1000x710x730 mm
CAPACITY: 6 GN1/1 &
6 trays 40x60 cm
SPACE BETWEEN TRAYS: 80 mm
POWER: 9.2 kW / 400V
TEMPERATURE: 30°C up to 240°C
FANS: 2 big auto-reverse rotation
FANS SPEED: 5 levels

INFO

Stainless steel casing
Steam percentage regulation up to 100%
Preheating function
Fast Cooling function
99 recipes | 3 phases
Built-in washing system
WiFi connection
Trays not included

EXTRA

Core probe 300€+V.A.T.

6.590€ + V.A.T.



OV 1011D

COMBI STEAMER OVEN WASH

DIMENSIONS: 1000x710x1090 mm
CAPACITY: 10 GN1/1 &
10 trays 40x60 cm
SPACE BETWEEN TRAYS: 80 mm
POWER: 13.8 kW / 400V
TEMPERATURE: 30°C up to 240°C
FANS: 3 auto-reverse rotation
FANS SPEED: 5 levels

INFO

Stainless steel casing
Steam percentage regulation up to 100%
Preheating function
Fast Cooling function
99 recipes | 3 phases
Built-in washing system
WiFi connection
Trays not included

EXTRA

Core probe 300€+V.A.T.

7.800€ + V.A.T.





OL 0511M

COMBI OVEN ANALOG



DIMENSIONS: 920x680x540 mm
CAPACITY: 5 trays 40x60 cm & GN1/1
SPACE BETWEEN TRAYS: 67 mm
POWER: 6.1 kW / 400V
TEMPERATURE: 50°C up to 270°C
FANS: 1 big auto-reverse rotation

INFO

Stainless steel
Analog steam percentage regulation
Trays not included

3.600 € + V.A.T.

OL 0611M

COMBI OVEN ANALOG



DIMENSIONS: 920x680x670 mm
CAPACITY: 6 trays 40x60 cm & GN1/1
SPACE BETWEEN TRAYS: 80 mm
POWER: 9.2 kW / 400V
TEMPERATURE: 50°C up to 270°C
FANS: 2 big auto-reverse rotation

INFO

Stainless steel
Analog steam percentage regulation
Trays not included

4.200 € + V.A.T.

OL 1011M

COMBI OVEN ANALOG



DIMENSIONS: 920x680x1020 mm
CAPACITY: 10 trays 40x60 cm & GN1/1
SPACE BETWEEN TRAYS: 80 mm
POWER: 13,8 kW / 400V
TEMPERATURE: 50°C up to 270°C
FANS: 3 big auto-reverse rotation

INFO

Stainless steel
Analog steam percentage regulation
Trays not included

5.390 € + V.A.T.

OVENS

COMBI STEAM OVENS

OL 1664M

COMBI OVEN ANALOG

DIMENSIONS: 1000x800x1810 mm
CAPACITY: 16 trays 40x60 cm
SPACE BETWEEN TRAYS: 80 mm
POWER: 23.1 Kw / 400 V
TEMPERATURE: 50°C up to 280°C
FANS: 5 big auto-reverse rotation

INFO

Stainless steel
Analog steam percentage regulation
Trays not included

13.700 € + V.A.T.

NEW

OL 1664D

COMBI STEAMER OVEN WASH

DIMENSIONS: 1000x800x1810mm
CAPACITY: 16 trays 40x60cm
SPACE BETWEEN TRAYS: 80mm
POWER: 23.1 Kw / 400 V
TEMPERATURE: 50°C up to 280°C
FANS: 5 big auto-reverse rotation
with adjustable speed

INFO

Stainless steel casing
Steam percentage regulation
Preheating function
Fast Cooling function
99 recipes | 3 phases
Built-in washing system
WiFi connection
Trays not included

15.700 € + V.A.T.

NEW



OL 2011M

COMBI OVEN ANALOG

DIMENSIONS: 1000x800x1810 mm

CAPACITY: 20 GN 1/1

SPACE BETWEEN TRAYS: 65 mm

POWER: 23.1 Kw / 400 V

TEMPERATURE: 50°C up to 280°C

FANS: 5 big auto-reverse rotation

INFO

Stainless steel

Analog steam percentage regulation

Trays not included

13.650 € + V.A.T.

NEW



OL 2011D

COMBI STEAMER OVEN WASH

DIMENSIONS: 1000x800x1810mm

CAPACITY: 20 GN 1/1

SPACE BETWEEN TRAYS: 80 mm

POWER: 23.1 Kw / 400 V

TEMPERATURE: 50°C up to 280°C

FANS: 5 big auto-reverse rotation
with adjustable speed

INFO

Stainless steel casing

Steam percentage regulation

Preheating function

Fast Cooling function

99 recipes | 3 phases

Built-in washing system

WiFi connection

Trays not included

14.950 € + V.A.T.

NEW

OVENS PROVERS



 100% MADE IN ITALY



OC 1064M

PROVER

DIMENSIONS: 970x680x750 mm
CAPACITY: 12 trays 40x60 cm
TEMPERATURE: 30°C up to 90°C
POWER: 0.7 kW / 230 V

SUITABLE FOR:

Vesta ovens

2.350 € + V.A.T.

TRAYS

LEC 4333

ALUMINIUM TRAY

DIMENSIONS: 460x330x15 mm

17 € + V.A.T.



LEC 30003

ALUMINIUM TRAY

DIMENSIONS: 442x325x15 mm

42 € + V.A.T.

LEC 30037

ALUMINIUM TRAY

DIMENSIONS: 480x345x8 mm

45 € + V.A.T.

1001001

ALUMINIUM TRAY

DIMENSIONS: 600x400x20 mm

51 € + V.A.T.



LEC 6040B

ALUMINIUM TRAY

DIMENSIONS: 600x400x20 mm

30 € + V.A.T.



LEC 60404

ALUMINIUM TRAY

DIMENSIONS: 600x400x40 mm

33 € + V.A.T.

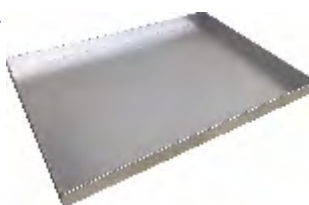

LEC 60405

ALUMINIUM TRAY

DIMENSIONS: 600x400x50 mm

38 € + V.A.T.

LEC 30005

ALUMINIUM PERFORATED TRAY

DIMENSIONS: 442x325x15 mm

42 € + V.A.T.

LEC 30010

ALUMINIUM PERFORATED TRAY

DIMENSIONS: 600x400x20 mm

50 € + V.A.T.

OVENS
GRILLS

GRI 30006

CHROME PLATED GRILL

DIMENSIONS: 442x325 mm

28 € + V.A.T.



GRI 48345

CHROME PLATED GRILL

DIMENSIONS: 480x345 mm

30 € + V.A.T.



GRI 30005

CHROME PLATED GRILL

DIMENSIONS: 600x400 mm

24 € + V.A.T.

OVEN CLEANERS

DET 30010

2in1 OVEN CLEANER / 5kg
DETERGENT & RINSE

105 € + V.A.T.

5102002

2in1 OVEN CLEANER / 10kg
DETERGENT & RINSE

125 € + V.A.T.

COFFEE MACHINE CLEANERS

DET225UN

POWDER CLEANER 900 gr

17,50 € + V.A.T.

OVENS

PIZZA OVENS

EP 30

PIZZA OVEN (1 PIZZA)

DIMENSIONS EXT.: 490x380x190 mm
GRILL DIMENSIONS: 360x340 mm
POWER: 1130 Watt
TEMPERATURE: 50°C up to 300°C

INFO
15' Timer
Stainless steel

260 € + V.A.T.



EP 60

PIZZA OVEN (2 PIZZA)

DIMENSIONS EXT.: 490x380x330 mm
GRILL DIMENSIONS: 360x340 mm
POWER: 2260 Watt
TEMPERATURE: 50°C up to 300°C

INFO
15' Timer
Stainless steel

590 € + V.A.T.



EP 2S

ANALOG PIZZA OVEN (2 PIZZA)

DIMENSIONS EXT.: 580x580x440 mm
DIMENSIONS INT.: 420x420x150 mm
CAPACITY: 2 pizza Ø30 cm
POWER: 3000 Watt / 230 V
TEMPERATURE: 50°C up to 300°C
THERMOSTATS: 1 analog (per resistance)

INFO
Fireproof stone
Timer
Stainless steel

465 € + V.A.T.





BP 135M

ANALOG PIZZA OVEN (1 PIZZA)

DIMENSIONS EXT.: 580x460x280 mm
DIMENSIONS INT.: 350x350x100 mm
CAPACITY: 1 pizza ø35 cm
POWER: 2.2 kW / 230 V
TEMPERATURE: 65°C up to 400°C
THERMOSTATS: 2 analog (per resistance)

INFO

30' timer
Internal illumination
Fireproof stone 1.5 cm thick
Stainless steel

680 € + V.A.T.



BP 235M

ANALOG PIZZA OVEN (2 PIZZA)

DIMENSIONS EXT.: 580x460x510 mm
DIMENSIONS INT.: 350x350x100 mm
CAPACITY: 2 pizza ø35 cm
POWER: 4.4 kW / 230 V
TEMPERATURE: 65°C up to 400°C
THERMOSTATS: 2 analog (per resistance)

INFO

30' timer
Internal illumination
Fireproof stone 1.5 cm thick
Stainless steel

1.035 € + V.A.T.

OVENS

PIZZA OVENS

BP 435M

PIZZA OVEN (1 PIZZA)

DIMENSIONS EXT.: 1000x950x415 mm
DIMENSIONS INT.: 720x720x140 mm
CAPACITY: 4 pizza ø35 cm
POWER: 6 kW / 400 V
TEMPERATURE: 45°C up to 450°C
THERMOSTATS: 2 analog (per resistance)

INFO

Internal illumination
Fireproof stone 1.4 cm thick
Stainless steel

2.280 € + V.A.T.



BP 635M

PIZZA OVEN (1 PIZZA)

DIMENSIONS EXT.: 1000x1315x415 mm
DIMENSIONS INT.: 720x1080x140 mm
CAPACITY: 6 pizza ø35 cm
POWER: 9 kW / 400 V
TEMPERATURE: 45°C up to 450°C
THERMOSTATS: 2 analog (per resistance)

INFO

Internal illumination
Fireproof stone 1.4 cm thick
Stainless steel

3.070 € + V.A.T.

BP 635MW

PIZZA OVEN (1 PIZZA)

DIMENSIONS EXT.: 1360x955x415 mm
DIMENSIONS INT.: 1080x720x140 mm
CAPACITY: 6 pizza ø35 cm
POWER: 9 kW / 400 V
TEMPERATURE: 45°C up to 450°C
THERMOSTATS: 2 analog (per resistance)

INFO

Internal illumination
Fireproof stone 1.4 cm thick
Stainless steel

3.005 € + V.A.T.

BP 935M

PIZZA OVEN (1 PIZZA)

DIMENSIONS EXT.: 1360x1315x415 mm
DIMENSIONS INT.: 1080x1080x140 mm
CAPACITY: 9 pizza ø35 cm
POWER: 13.2 kW / 400 V
TEMPERATURE: 45°C up to 450°C
THERMOSTATS: 2 analog (per resistance)

INFO

Internal illumination
Fireproof stone 1.4 cm thick
Stainless steel

3.225 € + V.A.T.



BP 835M

PIZZA OVEN (2 PIZZA)

DIMENSIONS EXT.: 1000x950x745 mm
DIMENSIONS INT.: 720x720x140 mm
CAPACITY: 4+4 pizza ø35 cm
POWER: 12 kW / 400 V
TEMPERATURE: 45°C up to 450°C
THERMOSTATS: 2 analog (per resistance)

INFO

Internal illumination
Fireproof stone 1.4 cm thick
Stainless steel

4.045 € + V.A.T.

BP 1235M

PIZZA OVEN (2 PIZZA)

DIMENSIONS EXT.: 1000x1315x745 mm
DIMENSIONS INT.: 720x1080x140 mm
CAPACITY: 6+6 pizza ø35 cm
POWER: 18 kW / 230 V
TEMPERATURE: 45°C up to 450°C
THERMOSTATS: 2 analog (per resistance)

INFO

Internal illumination
Fireproof stone 1.4 cm thick
Stainless steel

4.215 € + V.A.T.

BP 1235MW

PIZZA OVEN (2 PIZZA)

DIMENSIONS EXT.: 1360x955x745 mm
DIMENSIONS INT.: 1080x720x140 mm
CAPACITY: 6+6 pizza ø35 cm
POWER: 18 kW / 400 V
TEMPERATURE: 45°C up to 450°C
THERMOSTATS: 2 analog (per resistance)

INFO

Internal illumination
Fireproof stone 1.4 cm thick
Stainless steel

5.490 € + V.A.T.

BP 1835M

PIZZA OVEN (2 PIZZA)

DIMENSIONS EXT.: 1360x1315x745 mm
DIMENSIONS INT.: 1080x1080x140 mm
CAPACITY: 9+9 pizza ø35 cm
POWER: 26.4 kW / 400 V
TEMPERATURE: 45°C up to 450°C
THERMOSTATS: 2 analog (per resistance)

INFO

Internal illumination
Fireproof stone 1.4 cm thick
Stainless steel

6.025 € + V.A.T.

05

WASHING

Dishwashers

NANSIE SERIES [1 12]

UNDERCOUNTER [1 15]

HOOD-TYPE [124]

UTENSIL [127]

TUNNELS [130]

WATER SOFTENERS [132]

ACCESSORIES [133]



WASHING DISHWASHERS

NANSIE HOOD 500

HOOD-TYPE DISHWASHER

DIMENSIONS: 728x816x1505 mm
BASKET: 50x50 cm
USEFUL WASHING HEIGHT: 430 mm - GN 1/1
WASHING ARMS: Top & Bottom
RINSING ARMS: Top & Bottom
OUTPUT: 20-30 baskets/hour
CYCLE: 120" - 180"
WATER CONSUMPTION: 2,5lt/cycle
TANK TEMPERATURE: 60°C
BOILER TEMPERATURE: 82°C
TANK RESISTANCE: 3 kW
BOILER RESISTANCE: 10 kW
WASH PUMP: 750 W
TOTAL POWER: 10.800 W
TOTAL VOLTAGE: 400 V - 50 Hz
TANK CAPACITY: 20 lt
BOILER CAPACITY: 9,5 lt

INFO

Included:
Electric rinse aid pump
1 plate basket
1 glass basket

EXTRA

Water extraction pump 250 € + V.A.T.
Detergent pump 105€ + V.A.T.

3.850 € + V.A.T.



NANSIE 350

GLASS DISHWASHER ANALOG

DIMENSIONS: 415x530x680 mm
 BASKET: 35x35 cm
 USEFUL WASHING HEIGHT: 270 mm
 WASHING ARMS: Bottom
 RINSING ARMS: Top & Bottom
 OUTPUT: 20-30 baskets/hour
 CYCLE: 120" - 180"
 WATER CONSUMPTION: 2,4lt/cycle
 TANK / BOILER TEMPERATURE: 60°C / 82°C
 TANK / BOILER RESISTANCE: 1.6 kW / 2.6 kW
 WASH PUMP: 190 W
 TOTAL POWER / VOLTAGE: 2.770 W / 230 V - 50 Hz
 TANK CAPACITY: 10 lt
 BOILER CAPACITY: 2,5 lt



INFO

Included:
 Electric rinse aid pump
 1 cutlery rack

EXTRA

Water extraction pump 250 € + V.A.T.
 Detergent pump 105€ + V.A.T.

1.375 € + V.A.T.

NANSIE 400

GLASS DISHWASHER ANALOG

DIMENSIONS: 465x565x720 mm
 BASKET: 40x40 cm
 USEFUL WASHING HEIGHT: 310 mm
 WASHING ARMS: Bottom
 RINSING ARMS: Top & Bottom
 OUTPUT: 20-30 baskets/hour
 CYCLE: 120" - 180"
 WATER CONSUMPTION: 2,4lt/cycle
 TANK / BOILER TEMPERATURE: 60°C / 82°C
 TANK / BOILER RESISTANCE: 1.6 kW / 2.6 kW
 WASH PUMP: 190 W
 TOTAL POWER / VOLTAGE: 2.770 W / 230 V - 50 Hz
 TANK CAPACITY: 14 lt
 BOILER CAPACITY: 2,5 lt

INFO

Included:
 Electric rinse aid pump
 1 cutlery rack

EXTRA

Water extraction pump 250 € + V.A.T.
 Detergent pump 105€ + V.A.T.

1.460 € + V.A.T.

WASHING
UNDERCOUNTER



NANSIE 500

PLATE/GLASS DISHWASHER ANALOG

DIMENSIONS: 565x680x835 mm
BASKET: 50x50 cm
USEFUL WASHING HEIGHT: 340 mm
WASHING ARMS: Top & Bottom
RINSING ARMS: Top & Bottom
OUTPUT: 20-30 baskets/hour
CYCLE: 120" - 180"
WATER CONSUMPTION: 2,5lt/cycle
TANK / BOILER TEMPERATURE: 60°C / 82°C
TANK / BOILER RESISTANCE: 2 kW / 4,5 kW
WASH PUMP: 400 W
TOTAL POWER: 3.400 W
TOTAL VOLTAGE: 230 V / 400 V - 50 Hz
TANK CAPACITY: 26 lt
BOILER CAPACITY: 5,5 lt

INFO

Included:
Electric rinse aid pump
1 plate basket
1 glass basket

EXTRA

Water extraction pump 250 € + V.A.T.
Detergent pump 105€ + V.A.T.

1.895 € + V.A.T.



802010

DISHWASHER BASE WITH BASKET SIZE 50X50 cm

DIMENSIONS: 575x560x450 mm

INFO

Suitable for:
NANSIE 500

275 € + V.A.T.



ORION series



ORI 35.25

GLASS DISHWASHER DIGITAL

DIMENSIONS: 440x497x640 mm
 BASKET: 35x35 cm
 USEFUL WASHING HEIGHT: 250 mm
 WASHING ARMS: Bottom
 RINSING ARMS: Top & Bottom
 OUTPUT: 40-30-20-7 baskets/hour
 CYCLE: 90"-120"-180"-9'
 WATER CONSUMPTION: 2 lt/cycle
 TANK / BOILER TEMPERATURE: 60°C / 85°C
 TANK / BOILER RESISTANCE: 2.4 kW / 2.7 kW
 WASH PUMP: 190 W
 TOTAL POWER / VOLTAGE: 2.890 W / 230 V-50 Hz
 TANK CAPACITY: 10 lt
 BOILER CAPACITY: 3 lt

INFO

Included:
 Electric rinse aid pump
 2 glass baskets, 1 saucers' rack
 1 cutlery rack

EXTRA

Water extraction pump 250 € + V.A.T.
 Electric detergent pump 105€ + V.A.T.

1.650 € + V.A.T.



ORI 40.30

GLASS DISHWASHER DIGITAL

DIMENSIONS: 455x550x700 mm
 BASKET: 40x40 cm
 USEFUL WASHING HEIGHT: 300 mm
 WASHING ARMS: Bottom
 RINSING ARMS: Top & Bottom
 OUTPUT: 40-30-20-7 baskets/hour
 CYCLE: 90"-120"-180"-9'
 WATER CONSUMPTION: 2 lt/cycle
 TANK / BOILER TEMPERATURE: 60°C / 85°C
 TANK / BOILER RESISTANCE: 2.4 kW / 2.7 kW
 WASH PUMP: 190 W
 TOTAL POWER / VOLTAGE: 2.890 W / 230 V-50 Hz
 TANK CAPACITY: 12 lt
 BOILER CAPACITY: 3 lt

INFO

Tank filter
 Included:
 Electric rinse aid pump
 2 glass baskets, 1 saucers' rack
 1 cutlery rack

EXTRA

Water extraction pump 250 € + V.A.T.
 Electric detergent pump 105€ + V.A.T.

1.940 € + V.A.T.

Details that make the difference!



» **STAINLESS STEEL
WASH & RINSE ARMS**



» **PREFORMED
WASH TANK**



» **DOOR ARMS
30/10**

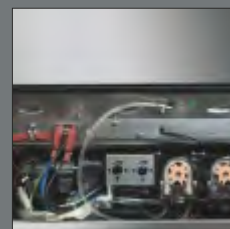

» **EASY SERVICE
ACCESS**

- » AISI304 stainless steel construction
- » Semi-double walls
- » Double door insulation

- » Electric rinse aid pump
- » Adjustable tank & boiler thermostat
- » Digital Control Panel - LCD screen

WASHING UNDERCOUNTER

100%
MADE IN
ITALY



ORION series

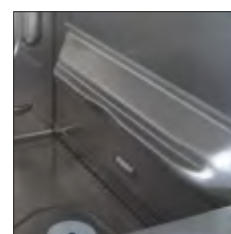

ORI 40.30 LS

PLATE/GLASS DISHWASHER DIGITAL

DIMENSIONS: 455x550x700 mm
BASKET: 40x40 cm
USEFUL WASHING HEIGHT: 290 mm
WASHING ARMS: Top & Bottom
RINSING ARMS: Top & Bottom
OUTPUT: 40-30-20-7 baskets/hour
CYCLE: 90" - 120" - 180" - 9'
WATER CONSUMPTION: 2 lt/cycle
TANK / BOILER TEMPERATURE: 60°C / 85°C
TANK / BOILER RESISTANCE: 2.4 kW / 2.7 kW
WASH PUMP: 330 W
TOTAL POWER / VOLTAGE: 3.030 W / 230 V - 50 Hz
TANK CAPACITY: 12 lt
BOILER CAPACITY: 3 lt

INFO

Tank filter
Included:
Electric rinse aid pump
1 glass basket
1 plate basket
1 cutlery rack

EXTRA

Water extraction pump 250 € + V.A.T.
Electric detergent pump 105€ + V.A.T.

ORI 45.30

PLATE/GLASS DISHWASHER DIGITAL

DIMENSIONS: 503x571x760 mm
BASKET: 45x45 cm
USEFUL WASHING HEIGHT: 290 mm
WASHING ARMS: Top & Bottom
RINSING ARMS: Top & Bottom
OUTPUT: 40-30-20-7 baskets/hour
CYCLE: 90" - 120" - 180" - 9'
WATER CONSUMPTION: 2 lt/cycle
TANK / BOILER TEMPERATURE: 60°C / 85°C
TANK / BOILER RESISTANCE: 2.4 kW / 2.7 kW
WASH PUMP: 550 W
TOTAL POWER / VOLTAGE: 3.250 W / 230 V - 50 Hz
TANK CAPACITY: 18 lt
BOILER CAPACITY: 5 lt

INFO

Tank filter
Included:
Electric rinse aid pump
1 glass basket
1 plate basket
1 cutlery rack

EXTRA

Water extraction pump 250 € + V.A.T.
Electric detergent pump 105€ + V.A.T.

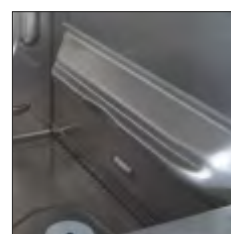
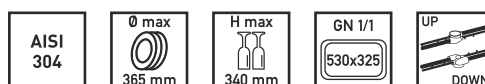
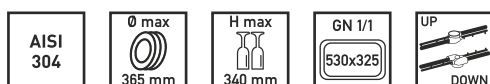

ORI 50.35 M

PLATE/GLASS DISHWASHER DIGITAL

DIMENSIONS: 572x633x814 mm
 BASKET: 50x50 cm
 USEFUL WASHING HEIGHT: 340mm - GN 1/1
 WASHING ARMS: Top & Bottom
 RINSING ARMS: Top & Bottom
 OUTPUT: 40-30-20-7 baskets/hour
 CYCLE: 90" - 120" - 180" - 9'
 WATER CONSUMPTION: 2 lt/cycle
 TANK / BOILER TEMPERATURE: 60°C / 85°C
 TANK / BOILER RESISTANCE: 2.4 kW / 2.7 kW
 WASH PUMP: 550 W
 TOTAL POWER / VOLTAGE: 3.250 W / 230 V - 50 Hz
 TANK CAPACITY: 20 lt
 BOILER CAPACITY: 5 lt

INFO

Tank filter
 Included:
 Electric rinse aid pump
 1 glass basket, 1 plate basket
 1 cutlery rack

EXTRA

Water extraction pump 250 € + V.A.T.
 Electric detergent pump 105€ + V.A.T.
 Kit for two baskets simultaneous washing 250€ + V.A.T.

2.580 € + V.A.T.

ORI 50.35 T

PLATE/GLASS DISHWASHER DIGITAL

DIMENSIONS: 572x633x814 mm
 BASKET: 50x50 cm
 USEFUL WASHING HEIGHT: 340 mm - GN 1/1
 WASHING ARMS: Top & Bottom
 RINSING ARMS: Top & Bottom
 OUTPUT: 40-30-20-7 baskets/hour
 CYCLE: 90" - 120" - 180" - 9'
 WATER CONSUMPTION: 2 lt/cycle
 TANK / BOILER TEMPERATURE: 60°C / 85°C
 TANK / BOILER RESISTANCE: 2.4 kW / 4.5 kW
 WASH PUMP: 550 W
 TOTAL POWER / VOLTAGE: 5.050 W / 400 V - 50 Hz
 TANK CAPACITY: 20 lt
 BOILER CAPACITY: 5 lt

INFO

Tank filter
 Included:
 Electric rinse aid pump
 1 glass basket, 1 plate basket
 1 cutlery rack

EXTRA

Water extraction pump 250 € + V.A.T.
 Electric detergent pump 105€ + V.A.T.
 Kit for two baskets simultaneous washing 250€ + V.A.T.

2.670 € + V.A.T.

WASHING UNDERCOUNTER

100%
MADE IN
ITALY



ORION series

ORI 40.30 LS PRS

PLATE/GLASS DISHWASHER DIGITAL

DIMENSIONS: 455x550x700 mm
BASKET: 40x40 cm
USEFUL WASHING HEIGHT: 290 mm
WASHING ARMS: Top & Bottom
RINSING ARMS: Top & Bottom
OUTPUT: 40-30-20-7 baskets/hour
CYCLE: 90'' - 120'' - 180'' - 9'
WATER CONSUMPTION: 2 lt/cycle
TANK TEMPERATURE: 60°C
BOILER TEMPERATURE: 85°C
TANK RESISTANCE: 2.4 kW
BOILER RESISTANCE: 2.7 kW
WASH PUMP: 330 W
TOTAL POWER: 3.030 W
TOTAL VOLTAGE: 230 V - 50 Hz
TANK CAPACITY: 12 lt
BOILER CAPACITY: 4 lt

INFO

Tank filter
Included:
Electric rinse aid & detergent pumps
2 glass baskets
1 saucers' rack
1 cutlery rack

EXTRA

Water extraction pump 250 € + V.A.T.

3.135 € + V.A.T.



- » AISI304 stainless steel construction
- » Semi-double walls
- » Double door insulation
- » Electric rinse aid pump
- » Thermostop system for constant boiler water temperature before rinse starting
- » Adjustable tank & boiler thermostat
- » Digital Control Panel - LCD screen
- » Self-cleaning program
- » Green Function - Energy saving
- » Soft Start System - Gradual and smooth start of the washing pump
- » Self-diagnosis system
- » Four washing programs
- » PRS system



AISI
304

Ø max
365 mm

H max
340 mm



GN 1/1
530x325

UP
DOWN

ORI 45.30 PRS

PLATE/GLASS DISHWASHER DIGITAL

DIMENSIONS: 503x571x760 mm
BASKET: 45x45cm
USEFUL WASHING HEIGHT: 290 mm
WASHING ARMS: Top & Bottom
RINSING ARMS: Top & Bottom
OUTPUT: 40-30-20-7 baskets/hour
CYCLE: 90'' - 120'' - 180'' - 9'
WATER CONSUMPTION: 2 lt/cycle
TANK TEMPERATURE: 60° C
BOILER TEMPERATURE: 85°C
TANK RESISTANCE: 2.4 kW
BOILER RESISTANCE: 6.0 kW
WASH PUMP: 550 W
TOTAL POWER: 6.550 W
TOTAL VOLTAGE: 400 V - 50 Hz
TANK CAPACITY: 18 lt
BOILER CAPACITY: 5,5 lt

INFO

Included:
Electric rinse aid & detergent pumps
1 glass basket
1 plate basket
1 cutlery rack

EXTRA

Water extraction pump 250 € + V.A.T.
Kit for two baskets simultaneous washing 250€ + V.A.T.

3.545 € + V.A.T.

ORI 50.35 PRS

PLATE/GLASS DISHWASHER DIGITAL

DIMENSIONS: 572x633x814 mm
BASKET: 50x50 cm
USEFUL WASHING HEIGHT: 340 mm - GN 1/1
WASHING ARMS: Top & Bottom
RINSING ARMS: Top & Bottom
OUTPUT: 40-30-20-7 baskets/hour
CYCLE: 90'' - 120'' - 180'' - 9'
WATER CONSUMPTION: 2 lt/cycle
TANK TEMPERATURE: 60°C
BOILER TEMPERATURE: 85°C
TANK RESISTANCE: 2.4 kW
BOILER RESISTANCE: 6.0 kW
WASH PUMP: 550 W
TOTAL POWER: 6.550 W
TOTAL VOLTAGE: 400 V - 50 Hz
TANK CAPACITY: 20 lt
BOILER CAPACITY: 5,5 lt

INFO

Tank filter
Included:
Electric rinse aid & detergent pumps
1 glass basket
1 plate basket
1 cutlery rack

EXTRA

Water extraction pump 250 € + V.A.T.
Kit for two baskets simultaneous washing 250€ + V.A.T.

3.840 € + V.A.T.

WASHING UNDERCOUNTER

PRS (Premium Rinse System)

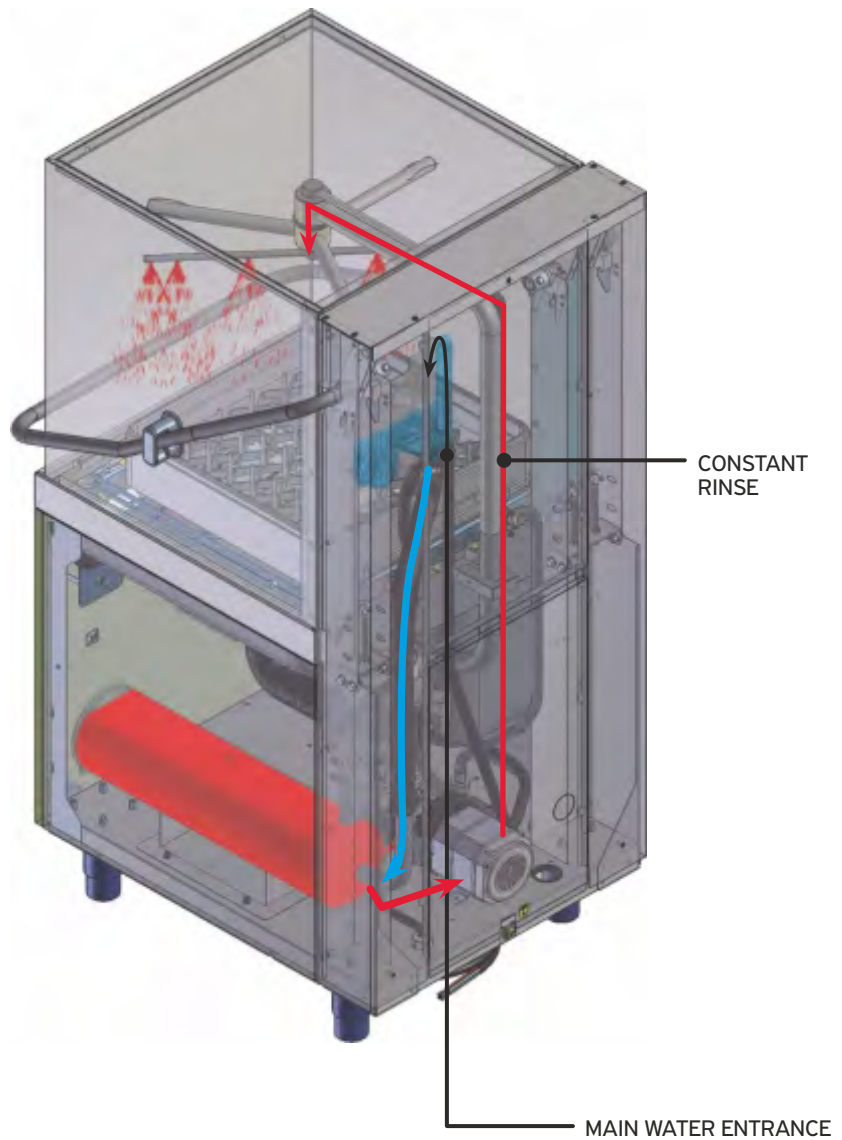
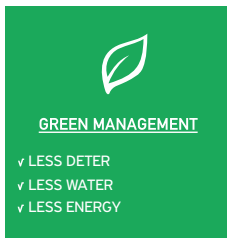

- » AISI304 stainless steel construction
- » Semi-double walls
- » Double door insulation
- » Electric rinse aid pump
- » Thermostop system for constant boiler water temperature before rinse starting
- » Adjustable tank & boiler thermostat
- » Digital Control Panel - LCD screen
- » Self-cleaning program
- » Green Function - Energy saving
- » Soft Start System - Gradual and smooth start of the washing pump
- » Self-diagnosis system
- » Four washing programs
- » PRS system



PRS
system

SD
system



ORI PRO 40.30 PRS SD

PLATE/GLASS DISHWASHER DIGITAL

DIMENSIONS: 483x550x700 mm
BASKET: 40x40 cm
USEFUL WASHING HEIGHT: 290 mm
WASHING ARMS: Top & Bottom
RINSING ARMS: Top & Bottom
OUTPUT: 40-30-20-7 baskets/hour
CYCLE: 90" - 120" - 180" - 9'
WATER CONSUMPTION: 2 lt/cycle
TANK TEMPERATURE: 60°C
BOILER TEMPERATURE: 85°C
TANK RESISTANCE: 2.4 kW
BOILER RESISTANCE: 5.4 kW
WASH PUMP: 330 W
TOTAL POWER: 5.730 W
TOTAL VOLTAGE: 380 V - 50 Hz
TANK CAPACITY: 12 lt
BOILER CAPACITY: 3 lt



INFO

Tank filter
Included:
Electric rinse aid & detergent pumps
2 glass baskets
1 saucers' rack
1 cutlery rack

4.100 € + V.A.T.

- » AISI304 stainless steel construction
- » Double walls
- » Double door insulation
- » Electric rinse aid & detergent pumps
- » Thermostop system for constant boiler water temperature before rinse starting
- » Adjustable tank & boiler thermostat
- » Digital Control Panel - LCD screen
- » Self-cleaning program
- » Green Function - Energy saving
- » Soft Start System - Gradual and smooth start of the washing pump
- » Self-diagnosis system
- » Four washing programs
- » PRS system
- » SD system

WASHING UNDERCOUNTER

100%
MADE IN
ITALY



ORION PRO series



ORI PRO 50.35 PRS SD

PLATE/GLASS DISHWASHER DIGITAL

DIMENSIONS: 600x633x814 mm
BASKET: 50x50 cm
USEFUL WASHING HEIGHT: 340 mm - GN 1/1
WASHING ARMS: Top & Bottom
RINSING ARMS: Top & Bottom
OUTPUT: 40-30-20-7 baskets/hour
CYCLE: 90'' - 120'' - 180'' - 9'
WATER CONSUMPTION: 2 lt/cycle
TANK TEMPERATURE: 60°C
BOILER TEMPERATURE: 85°C
TANK RESISTANCE: 2.4 kW
BOILER RESISTANCE: 6 kW
WASH PUMP: 550 W
TOTAL POWER: 6.550 W
TOTAL VOLTAGE: 400 V - 50 Hz
TANK CAPACITY: 20 lt
BOILER CAPACITY: 5.5 lt

INFO

Tank filter
Included:
Electric rinse aid & detergent pumps
1 glass basket
1 plate basket
1 cutlery rack

EXTRA

Kit for two baskets simultaneous washing 250€ + V.A.T.

ORI PRO 60.40 PRS SD

PLATE/GLASS DISHWASHER DIGITAL

DIMENSIONS: 600x703x850 mm
BASKET: 50x60 cm
USEFUL WASHING HEIGHT:
380mm - tray 60x40 cm
WASHING ARMS: Top & Bottom
RINSING ARMS: Top & Bottom
OUTPUT: 40-30-20-7 baskets/hour
CYCLE: 90'' - 120'' - 180'' - 9'
WATER CONSUMPTION: 2 lt/cycle
TANK TEMPERATURE: 60°C
BOILER TEMPERATURE: 85°C
TANK RESISTANCE: 2.4 kW
BOILER RESISTANCE: 6 kW
WASH PUMP: 680 W
TOTAL POWER: 6.680 W
TOTAL VOLTAGE: 400 V - 50 Hz
TANK CAPACITY: 22 lt
BOILER CAPACITY: 5.5 lt

INFO

Tank filter
Included:
Electric rinse aid & detergent pumps
1 glass basket
1 plate basket
1 cutlery rack

SD (Smart Drain System) Clean water function

SD system maintains the water tank level without using the overflow pipe, but employing an automatically actioned and electronically driven drain pump. Prior to starting to rinse with clean water, the SD system partially empties the water present in tank by draining the dirtiest water from the bottom & not from the top, as it used to be with the overflow pipe. This way all the clean water introduced during rinsing phase «regenerates» the tank water, increasing water quality. SD system is only available with PRS system. What are the benefits of SD system?

- » Improved washing performance in continuous & and intensive use.
- » Reduction of detergent consumption.
- » Energy & water saving.

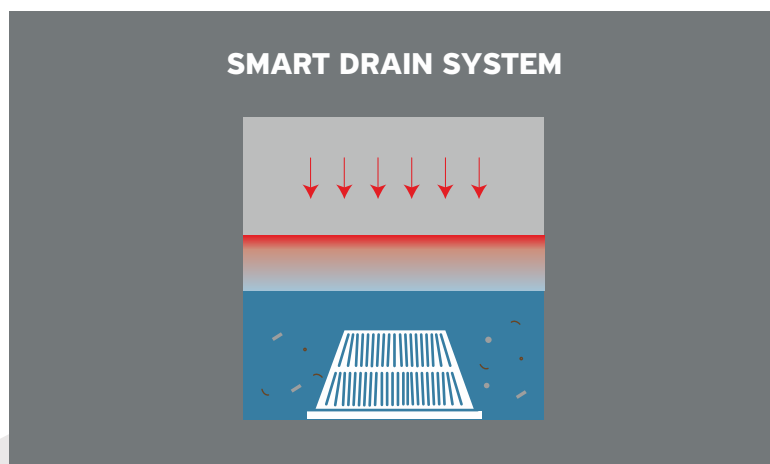
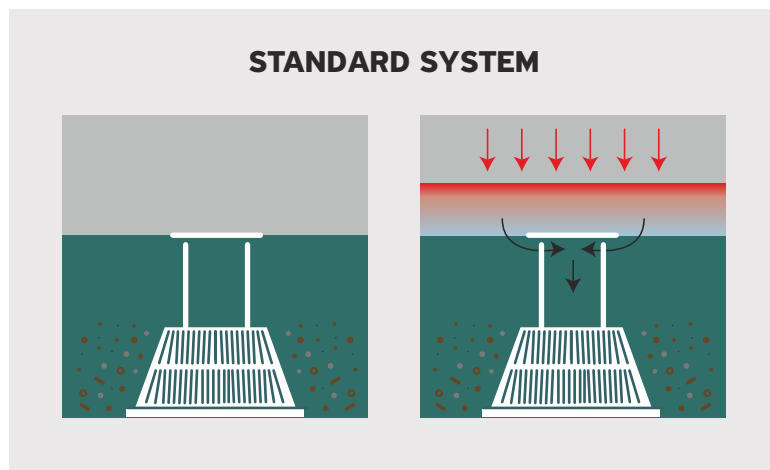

WASHING HOOD-TYPE

ARISTARCO since 1968
made for washing

PEGASUS series



PEG 50.42

HOOD-TYPE DISHWASHER DIGITAL

DIMENSIONS: 657/760x793x1494/1969 mm
 BASKET: 50x50 cm
 USEFUL WASHING HEIGHT: 425 mm - GN 1/1
 WASHING ARMS: Top & Bottom
 RINSING ARMS: Top & Bottom
 OUTPUT: 60-30-20-7 baskets/hour
 CYCLE: 60" - 120" - 180" - 9"
 WATER CONSUMPTION: 2.5 lt/cycle
 TANK TEMPERATURE: 60°C
 BOILER TEMPERATURE: 85°C
 TANK RESISTANCE: 2.8 kW
 BOILER RESISTANCE: 6 kW
 WASH PUMP: 750 W
 TOTAL POWER: 6.750 W
 TOTAL VOLTAGE: 400 V - 50 Hz
 TANK CAPACITY: 30 lt
 BOILER CAPACITY: 8 lt

INFO

Included:
 Electric rinse aid pump
 1 glass basket
 2 plate baskets
 2 cutlery racks

EXTRA

Water extraction pump 250 € + V.A.T.
 Electric detergent pump 105€ + V.A.T.

4.750 € + V.A.T.

PEG PRO 60.42 PWS

HOOD-TYPE DISHWASHER DIGITAL

DIMENSIONS: 681/785x793x1494/1969 mm
 BASKET: 50x60 cm
 USEFUL WASHING HEIGHT: 415 mm
 (suitable for tray 40x60cm)
 WASHING ARMS: Top & Bottom
 RINSING ARMS: Top & Bottom
 OUTPUT: 60-30-20-7 baskets/hour
 CYCLE: 60" - 120" - 180" - 9"
 WATER CONSUMPTION: 2.5 lt/cycle
 TANK TEMPERATURE: 60°C
 BOILER TEMPERATURE: 85°C
 TANK RESISTANCE: 4.5 kW
 BOILER RESISTANCE: 9 kW
 WASH PUMP: 1.300 W
 TOTAL POWER: 10.300 W
 TOTAL VOLTAGE: 400 V - 50 Hz
 TANK CAPACITY: 40 lt
 BOILER CAPACITY: 8 lt

INFO

Double-skinned insulated body
 Included:
 Electric rinse aid & detergent pumps
 1 glass basket, 2 plate baskets,
 2 cutlery racks

EXTRA

Water extraction pump 250 € + V.A.T.

8.210 € + V.A.T.

805025 AQUA P3

HOOD-TYPE DISHWASHER DIGITAL



DIMENSIONS: 690x830x1700 mm
BASKET: 62x57 cm
USEFUL WASHING HEIGHT: 620 mm
WASHING ARMS: Top & Bottom
RINSING ARMS: Top & Bottom
OUTPUT: 10-20 baskets/hour
CYCLE: 180" - 360"
WATER CONSUMPTION: 2.5 lt/cycle
TANK TEMPERATURE: 55°C
BOILER TEMPERATURE: 85°C
WASH PUMP: 2.200 W / 3hp
TOTAL POWER: 12.200W
TOTAL VOLTAGE: 400V - 50 Hz
TANK CAPACITY: 20 lt
BOILER CAPACITY: 9.5 lt

INFO

Double-skinned insulated body
Digital Control Panel
Cycle auto-start after door closing
Water extraction pump
Rinse aid pump
Detergent pump

7.490 € + V.A.T.

ES (Energy Saving System)

In ES system a tangential fan recycles the hot steam generated during the wash and rinse phases, making it pass through a highly efficient heat exchanger, with cold water circulating inside, provided by the water supply. The cold water supplied is introduced into the boiler at a temperature of approximately 45°C and the steam produced is used to heat the cold water (energy saving). We also avoid annoying emissions of steam with detergent in the work area, without using an external steam absorption system. ES system is only available with PRS system. What are the benefits of ES system?

- » Energy & water saving.
- » No need for external ventilation system.
- » No steam in working area.



UTENSIL

ARISTARCO since 1968
made for washing

HERCULES series

HER PRO COMPACT 60.40

UTENSIL DISHWASHER DIGITAL

The smallest
undercounter
utensil dishwasher!



DIMENSIONS: 600x703x850 mm
BASKET: 50x60 cm
USEFUL WASHING HEIGHT:
400 mm - tray 40x60 cm
WASHING ARMS: Top & Bottom
RINSING ARMS: Top & Bottom
OUTPUT: 30-15-10-7 baskets/hour
CYCLE: 2' - 4' - 6' - 9'
WATER CONSUMPTION: 2 lt/cycle
TANK / BOILER TEMPERATURE: 60°C / 85°C
TANK / BOILER RESISTANCE: 2.4 kW / 4.5 kW
WASH PUMP: 680 W
TOTAL POWER / VOLTAGE: 5.180 W / 400 V-50 Hz
TANK CAPACITY: 22 lt
BOILER CAPACITY: 5 lt

INFO

Tank filter
Double-skinned insulated body
Included:
Electric rinse aid & detergent pumps
1 utensil basket, 1 stainless steel rack for 4 trays 40x60 cm

EXTRA

Water extraction pump 250 € + V.A.T.

4.940 € + V.A.T.

Details that make the difference!



» **STAINLESS STEEL
WASH & RINSE ARMS**



» **PREFORMED
WASH TANK**



» **VERTICAL
PUMP**



» **EASY SERVICE
ACCESS**

- » AISI304 stainless steel construction
- » Double door insulation
- » Adjustable tank & boiler thermostat
- » Energy saving insulated boiler
- » AISI316 stainless steel tank & boiler
- » Analog or digital Control Panel - LCD screen

PLUS ΗΛΕΚΤΡΟΝΙΚΗΣ ΕΚΔΟΣΗΣ

- » Self-cleaning program
- » Green Function - Energy saving
- » Soft Start System - Gradual and smooth start of the washing pump
- » Self-diagnosis system
- » Four washing programs
- » Thermostop system for constant boiler water temperature before rinse starting
- » PRS system
- » SD system



HER 55.65 PRS

UTENSIL DISHWASHER DIGITAL

DIMENSIONS: 706x883x1829/1997 mm
 BASKET: 56.5x69 cm
 USEFUL WASHING HEIGHT:
 650 mm - tray 40x60 cm
 WASHING ARMS: Top & Bottom
 RINSING ARMS: Top & Bottom
 OUTPUT: 30 - 20 - 10 - 7 baskets/hour
 CYCLE: 2' - 3' - 6' - 9'
 WATER CONSUMPTION: 3 lt/cycle
 TANK / BOILER TEMPERATURE: 60°C / 85°C
 TANK / BOILER RESISTANCE: 2.8 kW / 6 kW
 WASH PUMP: 1.300 W
 TOTAL POWER / VOLTAGE: 7.300 W / 400 V-50 Hz
 TANK CAPACITY: 50 lt
 BOILER CAPACITY: 11 lt

INFO

Electric rinse aid pump
 PRS system
 Included:
 1 utensil basket

EXTRA

Water extraction pump 450 € + V.A.T.
 Electric detergent pump 105€ + V.A.T.

9.765 € + V.A.T.



HER PRO 65.65

PRS PWS

UTENSIL DISHWASHER DIGITAL

DIMENSIONS: 835x1023x1883/2111 mm
 BASKET: 66x81.5 cm
 USEFUL WASHING HEIGHT:
 650 mm - tray 60x80 cm
 WASHING ARMS: Top & Bottom
 RINSING ARMS: Top & Bottom
 OUTPUT: 30 - 20 - 10 - 7 baskets/hour
 CYCLE: 2' - 3' - 6' - 9'
 WATER CONSUMPTION: 3.5 lt/cycle
 TANK / BOILER TEMPERATURE: 60°C / 85°C
 TANK / BOILER RESISTANCE: 6 kW / 6 kW
 WASH PUMP: 2.300 W
 TOTAL POWER / VOLTAGE: 8.300 W / 400 V-50 Hz
 TANK CAPACITY: 65 lt
 BOILER CAPACITY: 11 lt

INFO

Electric rinse aid & detergent pumps
 Double-skinned insulated body
 PRS system
 Included:
 1 utensil basket

EXTRA

Water extraction pump 450 € + V.A.T.

17.495 € + V.A.T.



HER PRO 55.80 PRS PWS

UTENSIL DISHWASHER DIGITAL

DIMENSIONS: 740x876x2034/2330 mm
BASKET: 56.5x69 cm
USEFUL WASHING HEIGHT:
800 mm - tray 60x80 cm
WASHING ARMS: Top & Bottom
RINSING ARMS: Top & Bottom
OUTPUT: 30 - 20 - 10 - 7 baskets/hour
CYCLE: 2' - 3' - 6' - 9'
WATER CONSUMPTION: 3.5 lt/cycle
TANK / BOILER TEMPERATURE: 60°C / 85°C
TANK / BOILER RESISTANCE: 6 kW / 6 kW
WASH PUMP: 1.500 W
TOTAL POWER / VOLTAGE: 7.500 W / 400 V-50 Hz
TANK CAPACITY: 65 lt
BOILER CAPACITY: 11 lt

INFO

Electric rinse aid & detergent pumps
Double-skinned insulated body
PRS system
Included:
1 utensil basket

EXTRA

Water extraction pump 450 € + V.A.T.

13.395 € + V.A.T.



HER PRO 125.80 PRS PWS

UTENSIL DISHWASHER DIGITAL

DIMENSIONS: 1436x995x2034/2330 mm
BASKET: 126x81.5 cm
USEFUL WASHING HEIGHT:
800 mm - tray 60x80 cm
WASHING ARMS: Top & Bottom
RINSING ARMS: Top & Bottom
OUTPUT: 30 - 20 - 10 - 7 baskets/hour
CYCLE: 2' - 3' - 6' - 9'
WATER CONSUMPTION: 7 lt/cycle
TANK / BOILER TEMPERATURE: 60°C / 85°C
TANK / BOILER RESISTANCE: 9 kW / 9 kW
WASH PUMP: 2X3000 W
TOTAL POWER / VOLTAGE: 15.000 W / 400 V-50 Hz
TANK CAPACITY: 100 lt
BOILER CAPACITY: 17 lt

INFO

Electric rinse aid & detergent pumps
Double-skinned insulated body
PRS system
Included:
1 utensil basket

EXTRA

Water extraction pump 450 € + V.A.T.

27.220 € + V.A.T.

Details that make the difference!

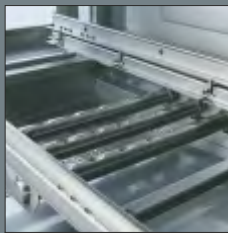

» **STAINLESS STEEL ARMS**



» **BOILER INSULATION INOX AISI316**



» **VERTICAL PUMP**



» **EASY SERVICE ACCESS**

- » AISI304 stainless steel construction
- » Double-skinned insulated body
- » Adjustable tank & boiler thermostat
- » Energy saving insulated boiler

- » Tank & boiler AISI316 stainless steel constructed
- » Analog or digital Control Panel - LCD screen



	TAU 1200	TAU 1650	TAU 2000	TAU 2500
DIMENSIONS	1150x770x1710/2110 mm	1550x770x1710/2110 mm	1800x770x1710/2110 mm	1800x770x1710/2110 mm
USEFUL HEIGHT	470 mm - GN 1/1	470 mm - GN 1/1	470 mm - GN 1/1	470 mm - GN 1/1
WASH PUMP	0.9 kw	2 kw	2 kw	2.35 kw
WATER CONSUMPTION	150 lt/h	165 lt/h	225 lt/h	240 lt/h
TANK RESISTANCE	9 kw	9 kw	12 kw	12 kw
BOILER RESISTANCE	9 kw	9 kw	12 kw	15 kw
TANK CAPACITY	65 lt	105 lt	105 lt	105 lt
BOILER CAPACITY	9 lt	9 lt	9 lt	2x9 lt
CYCLE	• Washing • Rinsing	• Washing • Rinsing	• Washing • Rinsing	• Washing • Rinsing
PROGRAMMES	3 Light/Standard/DIN10510	3 Light/Standard/DIN10510	3 Light/Standard/DIN10510	3 Light/Standard/DIN10510
BASKETS/HOUR	100/90/70	110/100/90	150/120/93	160/140/93
	TAU 2500 RR	TAU 3000	TAU 3500 RR	TAU 4000 RR
DIMENSIONS	2000x770x1710/2110 mm	2400x770x1710/2110 mm	2600x770x1710/2110 mm	2600x770x1710/2110 mm
USEFUL HEIGHT	470 mm - GN 1/1	470 mm - GN 1/1	470 mm - GN 1/1	470 mm - GN 1/1
WASH PUMP	2.35 kw	2.35 kw	2.35 kw	2.35 kw
WATER CONSUMPTION	240 lt/h	345 lt/h	325 lt/h	351 lt/h
TANK RESISTANCE	12 kw	12 kw	12 kw	12 kw
BOILER RESISTANCE	15 kw	18 kw	18 kw	21 kw
TANK CAPACITY	105 lt	105 lt	105 lt	105 lt
BOILER CAPACITY	2x9 lt	2x9 lt	2x9 lt	2x9 lt
CYCLE	• Washing • Double rinsing	• Washing • Rinsing	• Prewashing • Washing • Double rinsing	• Double washing • Double rinsing
PROGRAMMES	3 Light/Standard/DIN10510	3 Light/Standard/DIN10510	3 Light/Standard/DIN10510	3 Light/Standard/DIN10510
BASKETS/HOUR	170/150/105	230/200/145	250/220/145	270/250/145

CENTAURUS series



	CEN 3500	CEN 4000	CEN 6000	CEN 8000
DIMENSIONS	4500x985x1860/2200mm	5100x985x1860/2200 mm	6000x985x1860/2200 mm	7300x985x1860/2200 mm
USEFUL HEIGHT	710x450 mm	710x450 mm	710x450 mm	710x450 mm
WASH PUMP	2kw	2 kw	2 kw	2 kw
WATER CONSUMPTION	190 lt/h	230 lt/h	386 lt/h	504 lt/h
TANK RESISTANCE	14 kw	14 kw	14 kw	12 kw
BOILER RESISTANCE	10.5 kw	12 kw	18 kw	24 kw
TANK CAPACITY	100 lt	100 lt	100 lt	100 lt
BOILER CAPACITY	2x10 lt	2x10 lt	2x10 lt	2x10 lt
CYCLE	<ul style="list-style-type: none"> • Washing • Double rinsing 	<ul style="list-style-type: none"> • Washing • Rinsing 	<ul style="list-style-type: none"> • Double washing • Double rinsing 	<ul style="list-style-type: none"> • Prewashing • Double washing • Double rinsing
PROGRAMMES	5 Max / DIN10510	5 Max / DIN10510	5 Max / DIN10510	5 Max / DIN10510
BASKETS/HOUR	3.675 / 1950	4.050 / 2.400	6.450 / 4.200	8.100 / 5.250

» For further information contact our sales department.

WASHING WATER SOFTENERS

DVL111UN

WATER SOFTENER 8 LT

DIMENSIONS: Ø185x400 mm
TEMPERATURE: 60°C maximum
CONNECTION: 3/4
RESIN: 5,8 ltr

INFO

Manual resin regeneration with salt
Salt per regeneration 1 kg

175 € + V.A.T.



DVL211UN

WATER SOFTENER 12 LT

DIMENSIONS: Ø185x500 mm
TEMPERATURE: 60°C maximum
CONNECTION: 3/4
RESIN: 9 ltr

INFO

Manual resin regeneration with salt
Salt per regeneration 1,5 kg

195 € + V.A.T.



ACCESSORIES BASKETS



2462
GLASS BASKET
350x350x150 mm

18 € + V.A.T.



630 S
GLASS BASKET
380x380x150 mm

20 € + V.A.T.



2146
GLASS BASKET
400x400x150 mm

22 € + V.A.T.



2150
PLATE BASKET
400x400x110 mm

27 € + V.A.T.



2491
GLASS BASKET
450x450x165 mm

27 € + V.A.T.



2492
PLATE RACK
450x450x106 mm

29 € + V.A.T.



2493
CUTLERY RACK
450x450x106 mm

27 € + V.A.T.



240 N
GLASS RACK
500x500x106 mm

21 € + V.A.T.



239
CUTLERY RACK
500x500x106 mm

27 € + V.A.T.



237 N
PLATE RACK
500x500x106 mm

24 € + V.A.T.



238
DISK RACK
500x500x106 mm

32 € + V.A.T.



510
PLATE RACK
500x500x109 mm

24 € + V.A.T.



530
GENERAL USE RACK
500x500x109 mm

23 € + V.A.T.



550
GLASS RACK
500x500x106 mm

22 € + V.A.T.



570
RACK FOR TRAYS 40x60
500x500x109 mm

25 € + V.A.T.



2151
GLASS BASKET
400x400x130 mm

20 € + V.A.T.



ACCESSORIES BASKETS



5780
ROUND
GLASS BASKET
Ø350x160 (h) mm

25 € + V.A.T.



5782
ROUND
GLASS BASKET
Ø380x170 (h) mm

26 € + V.A.T.



5781
ROUND
GLASS BASKET
Ø400x180 (h) mm

28 € + V.A.T.



1878
EXTENDER
500x500x30 mm

10 € + V.A.T.



1879
EXTENDER
(GLASS DIVIDER OPTION)
500x500x50 mm

10 € + V.A.T.



6661
BASKET COVER
500x500x25 mm

25 € + V.A.T.



GLASS
SEPARATOR
Suitable for glass basket
50x50 cm

- 1884** 9 glasses Ø150 mm
- 1880** 16 glasses Ø110 mm
- 1881** 25 glasses Ø89 mm
- 1882** 36 glasses Ø73 mm
- 1883** 49 glasses Ø62 mm

10 € + V.A.T.



EXTENDER
WITH INCORPORATED
GLASS DIVIDER
Suitable for glass basket
50x50 cm

- 1009** 9 glasses Ø150 mm
- 1016** 16 glasses Ø110 mm
- 1025** 25 glasses Ø89 mm
- 1035** 36 glasses Ø73 mm
- 1049** 49 glasses Ø62 mm

15 € + V.A.T.



1877
TILTING CLIP
FOR GLASSES

Suitable for glass basket
40x40 cm

8 € + V.A.T.



6642
SQUARE
CUTLERY RACK
113x113x89 mm

3 € + V.A.T.



6643
8 COMPARTMENT
CUTLERY RACK
485x230x146 mm

22 € + V.A.T.



187
12 SAUCERS'
RACK
290x90x75 mm

8 € + V.A.T.



8395-0025
CONNECTION KIT FOR
TWO BASKETS 50x50 cm

250 € + V.A.T.

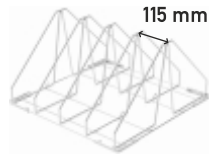

8080-0023
STAINLESS STEEL RACK
FOR 4 GN
 500x500x170 mm

250 € + V.A.T.

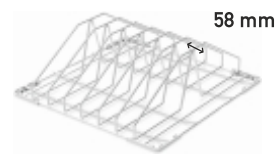

8380-0009
STAINLESS STEEL RACK
FOR 6 GN
 500x500x170 mm

250 € + V.A.T.



1368
FILTER UNIT 16LT

2 € + V.A.T.



KIT 01
INSTALLATION KIT
FOR RINSE AID PUMP

15 € + V.A.T.



PS
DRAIN PUMP
FACTORY INSTALLED

250 € + V.A.T.



B04 REG
RINSE AID PUMP
 ELECTRIC
 PERISTALTIC
 Adjustment 0-0,4l/h

110 € + V.A.T.



B08 REG
RINSE AID PUMP
 ELECTRIC
 PERISTALTIC
 Adjustment 0-0,8l/h

110 € + V.A.T.



D3 REG
DETERGENT PUMP
 ELECTRIC
 PERISTALTIC
 Adjustment 0-3l/h

105 € + V.A.T.



4120
3 WAYS DISTRIBUTOR

2 € + V.A.T.



2503
PRESSURE ATTACK

6 € + V.A.T.



5075
DETERGENT INJECTOR
FEED-THROUGH
STAINLESS STEEL

11 € + V.A.T.



1000
RINSE AID
INNER TUBE

15 € + V.A.T.



2000
DETERGENT
INNER TUBE

15 € + V.A.T.



61
RUBBER HOSE
TRANSPARENT

1 € + V.A.T.



610
RUBBER HOSE
BLUE

1 € + V.A.T.

06

ICEMAKERS

Icemakers

ARISTARCO

FULL ICE CUBE [138]

HOLLOW ICE CUBE [145]

FLAT ICE FLAKE [147]

STORAGE BINS [148]

PLUM

HOLLOW ICE CUBE [150]

DICE ICE CUBE [151]

GRANULAR ICE [153]

STORAGE BINS [154]

ICEMAKERS

FULL ICE CUBE

PHE 25.6 M A

FULL ICE CUBE ICEMAKER

DIMENSIONS: 365x520x600 mm
 FEET: + (0-20 mm)
 OUTPUT: 25 kg (≈ 1388 ice cubes) / 24h
 STORAGE CAPACITY: 6 kg
 POWER / VOLTAGE: 330 W / 230V/50Hz
 REFRIGERANT: R290
 COOLING SYSTEM: Air cooled

INFO

Ice cubes/cycle: 28
 Type: Solid ice cube 18gr

EXTRA

Air filter 50€+V.A.T.

1.525 € + V.A.T.



Reduced water consumption



Energy efficiency

Reduced maintenance costs



100% made in Italy

PHE 30.12 M A

FULL ICE CUBE ICEMAKER

DIMENSIONS: 390x550x690 mm
 FEET: + (0-20 mm)
 OUTPUT: 30 kg (≈ 1666 ice cubes) / 24h
 STORAGE CAPACITY: 12 kg
 POWER / VOLTAGE: 530 W / 230V/50Hz
 REFRIGERANT: R290
 COOLING SYSTEM: Air cooled

INFO

Ice cubes/cycle: 28
 Type: Solid ice cube 18gr

EXTRA

Air filter 50€+V.A.T.

1.810 € + V.A.T.

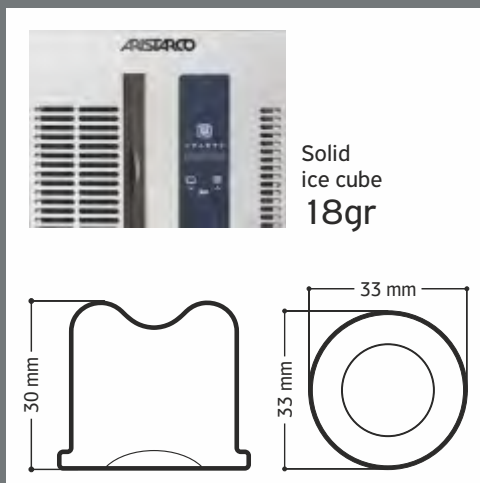

- » High density, pure, crystal clear solid ice cubes
- » Made entirely of stainless steel
- » Maximum efficiency
- » Latest technology
- » Compressor Tropical
- » Attractive and ergonomic design



Daily production is estimated at 21°C room temperature and 15°C water temperature

PHE 40.15 M A

FULL ICE CUBE ICEMAKER

DIMENSIONS: 500x600x685 mm
FEET: + (0-20 mm)
OUTPUT: 40 kg (≈ 2222 ice cubes) / 24h
STORAGE CAPACITY: 15 kg
POWER / VOLTAGE: 570 W / 230V/50Hz
REFRIGERANT: R290
COOLING SYSTEM: Air cooled

INFO

Ice cubes/cycle: 40
Type: Solid ice cube 18gr

EXTRA

Air filter 50€+V.A.T.

2.060 € + V.A.T.

PHE 50.25 M A

FULL ICE CUBE ICEMAKER

DIMENSIONS: 500x600x795 mm
FEET: + (0-20 mm)
OUTPUT: 50 kg (≈ 2778 ice cubes) / 24h
STORAGE CAPACITY: 25 kg
POWER / VOLTAGE: 570 W / 230V/50Hz
REFRIGERANT: R290
COOLING SYSTEM: Air cooled

INFO

Ice cubes/cycle: 40
Type: Solid ice cube 18gr

EXTRA

Air filter 50€+V.A.T.

2.300 € + V.A.T.



PHE 45.15 M A

FULL ICE CUBE ICEMAKER

DIMENSIONS: 500x600x685 mm
FEET: + (0-20 mm)
OUTPUT: 45 kg (≈ 2500 ice cubes) / 24h
STORAGE CAPACITY: 15 kg
POWER / VOLTAGE: 570 W / 230V/50Hz
REFRIGERANT: R290
COOLING SYSTEM: Air cooled

INFO

Ice cubes/cycle: 40
Type: Solid ice cube 18gr

EXTRA

Air filter 50€+V.A.T.

2.160 € + V.A.T.

PHE 60.40 M A

FULL ICE CUBE ICEMAKER

DIMENSIONS: 736x620x800 mm
FEET: + (40-50 mm)
OUTPUT: 60 kg (≈ 3333 ice cubes) / 24h
STORAGE CAPACITY: 40 kg
POWER / VOLTAGE: 570 W / 230V/50Hz
REFRIGERANT: R290
COOLING SYSTEM: Air cooled

INFO

Ice cubes/cycle: 64
Type: Solid ice cube 18gr

EXTRA

Air filter 50€+V.A.T.

2.900 € + V.A.T.

PHE 80.40 M A

FULL ICE CUBE ICEMAKER

DIMENSIONS: 736x620x900 mm
FEET: + (40-50 mm)
OUTPUT: 80 kg (≈ 4444 ice cubes) / 24h
STORAGE CAPACITY: 40 kg
POWER / VOLTAGE: 940 W / 230V/50Hz
REFRIGERANT: R290
COOLING SYSTEM: Air cooled

INFO

Ice cubes/cycle: 64
Type: Solid ice cube 18gr

EXTRA

Air filter 50€+V.A.T.

3.300 € + V.A.T.

ICEMAKERS

FULL ICE CUBE

PHE 100.55 M A

FULL ICE CUBE ICEMAKER

DIMENSIONS: 736x620x985 mm
FEET: + (40-50 mm)
OUTPUT: 100 kg (≈ 5556 ice cubes) / 24h
STORAGE CAPACITY: 60 kg
POWER / VOLTAGE: 1080 W / 230V/50Hz
REFRIGERANT: R290
COOLING SYSTEM: Air cooled

INFO

Ice cubes/cycle: 64
Type: Solid ice cube 18gr

EXTRA

Air filter 50€+V.A.T.

3.520 € + V.A.T.

PHE 135.70 M A

FULL ICE CUBE ICEMAKER

DIMENSIONS: 840x760x985 mm
FEET: + (40-50 mm)
OUTPUT: 135 kg (≈ 7500 ice cubes) / 24h
STORAGE CAPACITY: 75 kg
POWER / VOLTAGE: 1080 W / 230V/50Hz
REFRIGERANT: R290
COOLING SYSTEM: Air cooled

INFO

Ice cubes/cycle: 108
Type: Solid ice cube 18gr

EXTRA

Air filter 50€+V.A.T.

4.490 € + V.A.T.

PHE 165.70 M A

FULL ICE CUBE ICEMAKER

DIMENSIONS: 840x760x985 mm
FEET: + (40-50 mm)
OUTPUT: 165 kg (≈ 9167 ice cubes) / 24h
STORAGE CAPACITY: 75 kg
POWER / VOLTAGE: 1375 W / 230V/50Hz
REFRIGERANT: R290
COOLING SYSTEM: Air cooled

INFO

Ice cubes/cycle: 108
Type: Solid ice cube 18gr

EXTRA

Air filter 50€+V.A.T.

4.760 € + V.A.T.



Reduced water consumption



Energy efficiency



Reduced maintenance costs



100% made in Italy



AIR FILTER

50 € + V.A.T.

PHE 165 M A

FULL ICE CUBE ICEMAKER WITHOUT STORAGE BIN

DIMENSIONS: 870x530x785 mm
OUTPUT: 165 kg (≈ 9167 ice cubes) / 24h
POWER / VOLTAGE: 1375 W / 230V/50Hz
REFRIGERANT: R290
COOLING SYSTEM: Air cooled

INFO

Ice cubes/cycle: 108
Type: Solid ice cube 18gr

Suitable storage bin:

STS 250 | STS 400

EXTRA

Air filter 50€+V.A.T.

4.580 € + V.A.T.

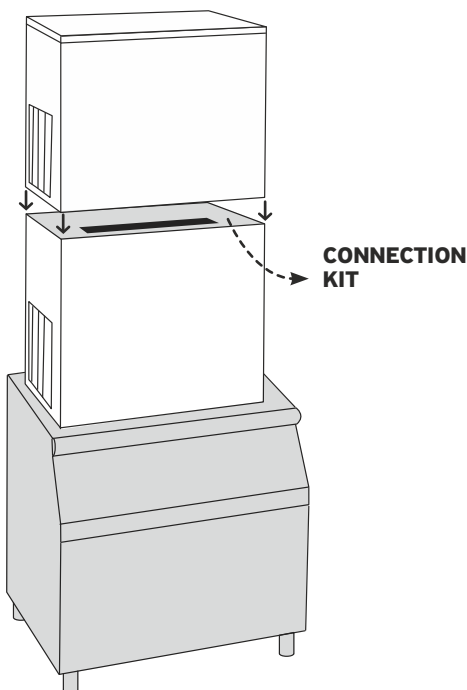

PHE 300 M A

FULL ICE CUBE ICEMAKER WITHOUT STORAGE BIN

DIMENSIONS: 1255x595x860 mm
OUTPUT: 300 kg (≈ 16667 ice cubes) / 24h
POWER / VOLTAGE: 2700 W / 230V/50Hz
REFRIGERANT: R452A
COOLING SYSTEM: Air cooled

INFO

Ice cubes/cycle: 216
Type: Solid ice cube 18gr

Suitable storage bin:

STS 400

EXTRA

Air filter 50€+V.A.T.

7.580 € + V.A.T.

ICEMAKERS

FULL ICE CUBE

PHE 25.6 L A

FULL ICE CUBE ICEMAKER

DIMENSIONS: 365x520x600 mm
FEET: + (0-20 mm)
OUTPUT: 25 kg (≈ 625 ice cubes) / 24h
STORAGE CAPACITY: 6 kg
POWER / VOLTAGE: 330 W / 230V/50Hz
REFRIGERANT: R290
COOLING SYSTEM: Air cooled

INFO

Ice cubes/cycle: 18
Type: Solid ice cube 36gr

EXTRA

Air filter 50€+V.A.T.

1.525 € + V.A.T.

PHE 30.12 L A

FULL ICE CUBE ICEMAKER

DIMENSIONS: 390x550x690 mm
FEET: + (0-20 mm)
OUTPUT: 30 kg (≈ 750 ice cubes) / 24h
STORAGE CAPACITY: 12 kg
POWER / VOLTAGE: 530 W / 230V/50Hz
REFRIGERANT: R290
COOLING SYSTEM: Air cooled

INFO

Ice cubes/cycle: 18
Type: Solid ice cube 36gr

EXTRA

Air filter 50€+V.A.T.

1.810 € + V.A.T.

PHE 40.15 L A

FULL ICE CUBE ICEMAKER

DIMENSIONS: 500x600x685 mm
FEET: + (0-20 mm)
OUTPUT: 40 kg (≈ 1111 ice cubes) / 24h
STORAGE CAPACITY: 15 kg
POWER / VOLTAGE: 570 W / 230V/50Hz
REFRIGERANT: R290
COOLING SYSTEM: Air cooled

INFO

Ice cubes/cycle: 24
Type: Solid ice cube 36gr

EXTRA

Air filter 50€+V.A.T.

2.060 € + V.A.T.



Reduced water consumption



Energy efficiency



Reduced maintenance costs



100% made in Italy



- » High density, pure, crystal clear solid ice cubes
- » Made entirely of stainless steel
- » Maximum efficiency
- » Latest technology
- » Compressor Tropical
- » Attractive and ergonomic design



Daily production is estimated at 21°C room temperature and 15°C water temperature



PHE 45.15 L A

FULL ICE CUBE ICEMAKER

DIMENSIONS: 500x600x685 mm
FEET: + (0-20 mm)
OUTPUT: 45 kg (≈ 1250 ice cubes) / 24h
STORAGE CAPACITY: 15 kg
POWER / VOLTAGE: 570 W / 230V/50Hz
REFRIGERANT: R290
COOLING SYSTEM: Air cooled

INFO

Ice cubes/cycle: 24
Type: Solid ice cube 36gr

EXTRA

Air filter 50€+V.A.T.

2.160 € + V.A.T.

PHE 50.25 L A

FULL ICE CUBE ICEMAKER

DIMENSIONS: 500x600x795 mm
FEET: + (0-20 mm)
OUTPUT: 50 kg (≈ 1390 ice cubes) / 24h
STORAGE CAPACITY: 25 kg
POWER / VOLTAGE: 570 W / 230V/50Hz
REFRIGERANT: R290
COOLING SYSTEM: Air cooled

INFO

Ice cubes/cycle: 24
Type: Solid ice cube 36gr

EXTRA

Air filter 50€+V.A.T.

2.300 € + V.A.T.

PHE 60.40 L A

FULL ICE CUBE ICEMAKER

DIMENSIONS: 736x620x800 mm
FEET: + (40-50 mm)
OUTPUT: 60 kg (≈ 1667 ice cubes) / 24h
STORAGE CAPACITY: 40 kg
POWER / VOLTAGE: 570 W / 230V/50Hz
REFRIGERANT: R290
COOLING SYSTEM: Air cooled

INFO

Ice cubes/cycle: 36
Type: Solid ice cube 36gr

EXTRA

Air filter 50€+V.A.T.

2.900 € + V.A.T.

PHE 80.40 L A

FULL ICE CUBE ICEMAKER

DIMENSIONS: 736x620x900 mm
FEET: + (40-50 mm)
OUTPUT: 80 kg (≈ 2222 ice cubes) / 24h
STORAGE CAPACITY: 40 kg
POWER / VOLTAGE: 940 W / 230V/50Hz
REFRIGERANT: R290
COOLING SYSTEM: Air cooled

INFO

Ice cubes/cycle: 36
Type: Solid ice cube 36gr

EXTRA

Air filter 50€+V.A.T.

3.300 € + V.A.T.

PHE 100.55 L A

FULL ICE CUBE ICEMAKER

DIMENSIONS: 736x620x985 mm
FEET: + (40-50 mm)
OUTPUT: 100 kg (≈ 2778 ice cubes) / 24h
STORAGE CAPACITY: 60 kg
POWER / VOLTAGE: 1080 W / 230V/50Hz
REFRIGERANT: R290
COOLING SYSTEM: Air cooled

INFO

Ice cubes/cycle: 36
Type: Solid ice cube 36gr

EXTRA

Air filter 50€+V.A.T.

3.520 € + V.A.T.

ICEMAKERS FULL ICE CUBE

PHOENIX series **ARISTARCO**
ICE PLEASE!

PHE 135.70 L A

FULL ICE CUBE ICEMAKER

DIMENSIONS: 840x760x985 mm
FEET: + (40-50 mm)
OUTPUT: 135 kg (= 3750 ice cubes) / 24h
STORAGE CAPACITY: 75 kg
POWER / VOLTAGE: 1080 W / 230V/50Hz
REFRIGERANT: R290
COOLING SYSTEM: Air cooled

INFO

Ice cubes/cycle: 60
Type: Solid ice cube 36gr

EXTRA

Air filter 50€+V.A.T.

4.490 € + V.A.T.



Reduced water consumption



Energy efficiency



Reduced maintenance costs



100% made in Italy



PHE 165 L A

FULL ICE CUBE ICEMAKER WITHOUT STORAGE BIN

DIMENSIONS: 870x530x785 mm
OUTPUT: 165 kg (= 4583 ice cubes) / 24h
POWER / VOLTAGE: 1375 W / 230V / 50Hz
REFRIGERANT: R290
COOLING SYSTEM: Air cooled

INFO

Ice cubes/cycle: 60
Type: Solid ice cube 36gr
Suitable storage bin:
STS 250, STS 400

EXTRA

Air filter 50€+V.A.T.

4.580 € + V.A.T.

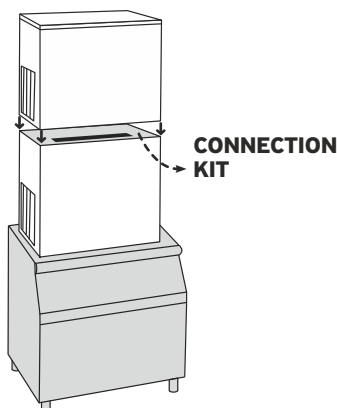

PHE 300 L A

FULL ICE CUBE ICEMAKER WITHOUT STORAGE BIN

DIMENSIONS: 1255x595x860 mm
OUTPUT: 280 kg (\approx 7778 ice cubes) / 24h
POWER / VOLTAGE: 2700 W / 230V/50Hz
REFRIGERANT: R452a
COOLING SYSTEM: Air cooled

INFO

Ice cubes/cycle: 120
Type: Solid ice cube 36gr
Suitable storage bin:
STS 400

EXTRA

Air filter 50€+V.A.T.

7.580 € + V.A.T.

HOLLOW ICE CUBE

LYNX series **ARISTARCO**
ICE PLEASE!



Hollow ice cube
21 gr

- » High density, pure, crystal clear solid ice cubes
- » Made entirely of stainless steel
- » Maximum efficiency
- » Latest technology
- » Compressor Tropical
- » Attractive and ergonomic design

 Daily production is estimated at 21°C room temperature and 15°C water temperature



Reduced water consumption



Energy efficiency



Reduced maintenance costs



100% made in Italy

LYN 20.5 A

HOLLOW ICE CUBE ICEMAKER

DIMENSIONS: 340x545x620 mm
FEET: + (0-10 mm)
OUTPUT: 20 kg (≈ 952 ice cubes) / 24h
STORAGE CAPACITY: 5 kg
POWER / VOLTAGE: 220 W / 230V/50Hz
REFRIGERANT: R290
COOLING SYSTEM: Air cooled

INFO

Ice cubes/cycle: 15
Type: Hollow ice cube 21gr

1.945 € + V.A.T.

LYN 35.12 A

HOLLOW ICE CUBE ICEMAKER

DIMENSIONS: 450x545x690 mm
FEET: + (0-10 mm)
OUTPUT: 35 kg (≈ 1666 ice cubes) / 24h
STORAGE CAPACITY: 12 kg
POWER / VOLTAGE: 230 W / 230V/50Hz
REFRIGERANT: R290
COOLING SYSTEM: Air cooled

INFO

Ice cubes/cycle: 20
Type: Hollow ice cube 21gr

2.390 € + V.A.T.

LYN 25.7 A

HOLLOW ICE CUBE ICEMAKER

DIMENSIONS: 340x545x690 mm
FEET: + (0-10 mm)
OUTPUT: 25 kg (≈ 1190 ice cubes) / 24h
STORAGE CAPACITY: 7 kg
POWER / VOLTAGE: 200 W / 230V/50Hz
REFRIGERANT: R290
COOLING SYSTEM: Air cooled

INFO

Ice cubes/cycle: 15
Type: Hollow ice cube 21gr

2.050 € + V.A.T.

LYN 45.16 A

HOLLOW ICE CUBE ICEMAKER

DIMENSIONS: 500x600x690 mm
FEET: + (0-10 mm)
OUTPUT: 45 kg (≈ 2143 ice cubes) / 24h
STORAGE CAPACITY: 16 kg
POWER / VOLTAGE: 240 W / 230V/50Hz
REFRIGERANT: R290
COOLING SYSTEM: Air cooled

INFO

Ice cubes/cycle: 35
Type: Hollow ice cube 21gr

2.755 € + V.A.T.

ICEMAKERS

HOLLOW ICE CUBE

LYNX series **ARISTARCO**
ICE PLEASE!

LYN 50.21 A

HOLLOW ICE CUBE ICEMAKER

DIMENSIONS: 500x585x880 mm
FEET: + (80-100 mm)
OUTPUT: 50 kg (≈ 2380 ice cubes) / 24h
STORAGE CAPACITY: 21 kg
POWER / VOLTAGE: 310 W / 230V/50Hz
REFRIGERANT: R290
COOLING SYSTEM: Air cooled

INFO

Ice cubes/cycle: 35
Type: Hollow ice cube 21 gr

2.960 € + V.A.T.



LYN 60.28 A

HOLLOW ICE CUBE ICEMAKER

DIMENSIONS: 600x585x880 mm
FEET: + (80-100 mm)
OUTPUT: 60 kg (≈ 2587 ice cubes) / 24h
STORAGE CAPACITY: 28 kg
POWER / VOLTAGE: 460 W / 230V/50Hz
REFRIGERANT: R290
COOLING SYSTEM: Air cooled

INFO

Ice cubes/cycle: 35
Type: Hollow ice cube 21 gr

3.405 € + V.A.T.



Reduced water consumption



Energy efficiency



Reduced maintenance costs



100% made in Italy

LYN 90.40 A

HOLLOW ICE CUBE ICEMAKER

DIMENSIONS: 800x585x880 mm
FEET: + (80-100 mm)
OUTPUT: 90 kg (≈ 4285 ice cubes) / 24h
STORAGE CAPACITY: 40 kg
POWER / VOLTAGE: 600 W / 230V/50Hz
REFRIGERANT: R290
COOLING SYSTEM: Air cooled

INFO

Ice cubes/cycle: 60
Type: Hollow ice cube 21 gr

4.180 € + V.A.T.



Hollow ice cube
21 gr

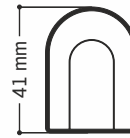
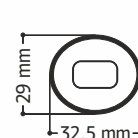

Daily production is estimated at 21°C room temperature and 15°C water temperature

FLAT ICE FLAKE



Flat ice flakes
thickness
1,5 mm



- » Made entirely of stainless steel
- » Maximum efficiency
- » Latest technology
- » Attractive and ergonomic design



Daily production is estimated
at 21°C room temperature
and 15°C water temperature



Reduced
water
consumption



Energy
efficiency



Reduced
maintainance
costs



100%
made in Italy

AND 250 A

FLAT FLAKE ICEMAKER

DIMENSIONS: 1015x590x765 mm
FEET: + (20-50 mm)
OUTPUT: 250 kg / 24h
POWER / VOLTAGE: 1000 W / 230V/50Hz
REFRIGERANT: R452a
COOLING SYSTEM: Air cooled

INFO

Type: Flat ice flake
Suitable storage bin:
STS 400, STSD 500, STC 600

13.220 € + V.A.T.

AND 600 A

FLAT FLAKE ICEMAKER

DIMENSIONS: 1110x640x800 mm
FEET: + (20-50 mm)
OUTPUT: 600 kg / 24h
POWER / VOLTAGE: 2600 W / 400V/50Hz
REFRIGERANT: R452a
COOLING SYSTEM: Air cooled

INFO

Type: Flat ice flake
Suitable storage bin:
STS 400, STSD 500, STSD 1000, STC 600

15.800 € + V.A.T.

AND 1000 A

FLAT FLAKE ICEMAKER

DIMENSIONS: 1110x640x840 mm
FEET: + (20-50 mm)
OUTPUT: 1000 kg / 24h
POWER / VOLTAGE: 4500 W / 400V/50Hz
REFRIGERANT: R452a
COOLING SYSTEM: Air cooled

INFO

Type: Flat ice flake
Suitable storage bin:
STS 400, STSD 500, STSD 1000, STC 600

20.230 € + V.A.T.

AND 1500 A

FLAT FLAKE ICEMAKER

DIMENSIONS: 1380x740x970 mm
FEET: + (20-50 mm)
OUTPUT: 1500 kg / 24h
POWER / VOLTAGE: 5500 W / 400V/50Hz
REFRIGERANT: R452a
COOLING SYSTEM: Air cooled

INFO

Type: Flat ice flake
Suitable storage bin:
STSD 1000, STC 600

27.000 € + V.A.T.

ICEMAKERS
STORAGE BINS

STS series **ARISTARCO**
ICE PLEASE!

STS 150

STORAGE BIN

DIMENSIONS: 569x850(1034)x1048 mm
CAPACITY: 130 kg

1.995 € + V.A.T.

STS 200

STORAGE BIN

DIMENSIONS: 769x850(1034)x1048 mm
CAPACITY: 180 kg

2.095 € + V.A.T.

STS 250

STORAGE BIN

DIMENSIONS: 1081x824(944)x968 mm
CAPACITY: 250 kg

INFO

Suitable for:
PHE 165 M A, PHE 165 L A

2.720 € + V.A.T.

STS 400

STORAGE BIN

DIMENSIONS: 1235x873(1155)x1270 mm
CAPACITY: 400 kg

INFO

Suitable for:
PHE 165 M A, PHE 300 M A, PHE 165 L A,
PHE 280 L A, AND 250 A, AND 600 A, AND 1000 A

3.440 € + V.A.T.



Reduced
water
consumption



Energy
efficiency



Reduced
maintainance
costs



100%
made in Italy



- » Made entirely of stainless steel
- » Maximum efficiency
- » Latest technology
- » Attractive and ergonomic design



STSD 500

STORAGE BIN

DIMENSIONS: 1220x1128(1410)x1427 mm
CAPACITY: 550 kg

INFO

Suitable for:
AND 250 A, AND 600 A, AND 1000 A

8.980 € + V.A.T.



STC 150

STORAGE BIN WITH CART

DIMENSIONS: 885x1025(1169)x1343 mm
CAPACITY: 137+73 kg

7.965 € + V.A.T.

STC 300

STORAGE BIN WITH CART

DIMENSIONS: 885x1267(1553)x1803 mm
CAPACITY: 318+73 kg

10.700 € + V.A.T.

STSD 1000

STORAGE BIN

DIMENSIONS: 1830x1470(1750)x1290 mm
CAPACITY: 550 kg

INFO

Suitable for:
AND 600 A, AND 1000 A, AND 1500 A

12.560 € + V.A.T.

STC 600

STORAGE BIN WITH 2 CARTS

DIMENSIONS: 1753x1267(1553)x1803 mm
CAPACITY: 613+146 kg

INFO

Suitable for:
AND 250 A, AND 600 A, AND 1000 A, AND 1500 A

18.430 € + V.A.T.

ICEMAKERS

FULL ICE CUBE

SD 31

FULL ICE CUBE ICEMAKER

DIMENSIONS: 375x575x762 mm
OUTPUT: 25 kg / 24h
STORAGE CAPACITY: 15 kg
POWER / VOLTAGE: 300 W / 230V/50Hz
REFRIGERANT: R290
COOLING SYSTEM: Air cooled

INFO

Type: Hollow ice cube Ø28x39 mm, weight 15gr

1.380 € + V.A.T.



SD 41

FULL ICE CUBE ICEMAKER

DIMENSIONS: 375x575x762 mm
OUTPUT: 35 kg / 24h
STORAGE CAPACITY: 15 kg
POWER / VOLTAGE: 320 W / 230V/50Hz
REFRIGERANT: R290
COOLING SYSTEM: Air cooled

INFO

Type: Hollow ice cube Ø28x39 mm, weight 15gr

1.620 € + V.A.T.

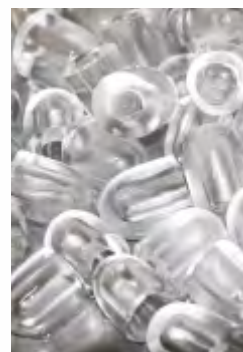

Hollow
ice cube
15gr



Daily production is estimated
at 21°C room temperature
and 15°C water temperature

SDU 61

FULL ICE CUBE ICEMAKER

DIMENSIONS: 667x637x775 mm
OUTPUT: 55 kg / 24h
STORAGE CAPACITY: 30 kg
POWER / VOLTAGE: 500 W / 230V/50Hz
REFRIGERANT: R290
COOLING SYSTEM: Air cooled

INFO

Type: Hollow ice cube Ø28x39 mm, weight 15gr

3.070 € + V.A.T.



DICE ICE CUBE



Dice ice cube
16gr
17gr
20gr

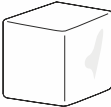

i Daily production is estimated at 21°C room temperature and 15°C water temperature

SQ 61

DICE ICE CUBE ICEMAKER

DIMENSIONS: 500x590x850 mm
OUTPUT: 55 kg / 24h
STORAGE CAPACITY: 18 kg
POWER / VOLTAGE: 360 W / 230V/50Hz
REFRIGERANT: R290
COOLING SYSTEM: Air cooled

INFO

Type: Dice ice cube 28x32x22mm, weight 16gr

1.915 € + V.A.T.

SQU 81

DICE ICE CUBE ICEMAKER

DIMENSIONS: 660x640x785 mm
OUTPUT: 80 kg / 24h
STORAGE CAPACITY: 25 kg
POWER / VOLTAGE: 420 W / 230V/50Hz
REFRIGERANT: R404a
COOLING SYSTEM: Air cooled

INFO

Type: Dice ice cube 28x32x22mm, weight 16gr

3.235 € + V.A.T.

SQ 61PT

DICE ICE CUBE ICEMAKER

DIMENSIONS: 500x590x850 mm
OUTPUT: 55 kg / 24h
STORAGE CAPACITY: 18 kg
POWER / VOLTAGE: 300 W / 230V/50Hz
REFRIGERANT: R290
COOLING SYSTEM: Air cooled

INFO

Type: Dice ice cube 28x32x22mm, weight 16gr

2.015 € + V.A.T.

SQ 100

DICE ICE CUBE ICEMAKER

DIMENSIONS: 660x685x920 mm
OUTPUT: 95 kg / 24h
STORAGE CAPACITY: 36 kg
POWER / VOLTAGE: 580 W / 230V/50Hz
REFRIGERANT: R404a
COOLING SYSTEM: Air cooled

INFO

Type: Dice ice cube 28x32x22mm weight 16gr

2.860 € + V.A.T.

SQ 61



SQU 81



SQ 61PT



SQ 100



ICEMAKERS

DICE ICE CUBE

SQ 130

DICE ICE CUBE ICEMAKER

DIMENSIONS: 660x685x920 mm
OUTPUT: 130 kg / 24h
STORAGE CAPACITY: 36 kg
POWER / VOLTAGE: 580 W / 230V/50Hz
REFRIGERANT: R290
COOLING SYSTEM: Air cooled

INFO

Type: Dice ice cube 32x32x22 mm, weight 17 gr

3.560 € + V.A.T.



SQ 231

DICE ICE CUBE ICEMAKER WITHOUT STORAGE BIN

DIMENSIONS: 760x618x568 mm
OUTPUT: 225 kg / 24h
POWER / VOLTAGE: 1240 W / 230V/50Hz
REFRIGERANT: R290
COOLING SYSTEM: Air cooled

INFO

Type: Dice ice cube 38x38x22 mm, weight 20 gr

Suitable storage bin:
BIN 200, BIN 360

5.115 € + V.A.T.



SQ 231 + BIN 200

SQ 501

DICE ICE CUBE ICEMAKER WITHOUT STORAGE BIN

DIMENSIONS: 760x618x743 mm
OUTPUT: 455 kg / 24h
POWER / VOLTAGE: 2300 W / 230V/50Hz
REFRIGERANT: R404a
COOLING SYSTEM: Air cooled

INFO

Type: Dice ice cube 38x38x22 mm, weight 20 gr

Suitable storage bin:
BIN 200, BIN 360

7.095 € + V.A.T.



GRANULAR ICE



GS 60.20

GRANULAR ICE WITH STORAGE BIN

DIMENSIONS: 520x550x960 mm
OUTPUT: 60 kg / 24h
STORAGE CAPACITY: 20 kg
POWER / VOLTAGE: 300 W / 230V/50Hz
REFRIGERANT: R290
COOLING SYSTEM: Air cooled

INFO
Type: Granular ice

4.830 € + V.A.T.

GS 450 + BIN 275



GS 130.50

GRANULAR ICE WITH STORAGE BIN

DIMENSIONS: 650x640x1050 mm
OUTPUT: 130 kg / 24h
STORAGE CAPACITY: 50 kg
POWER / VOLTAGE: 350 W / 230V/50Hz
REFRIGERANT: R290
COOLING SYSTEM: Air cooled

INFO
Type: Granular ice

6.000 € + V.A.T.

GS 450

GRANULAR ICE WITHOUT STORAGE BIN

DIMENSIONS: 560x620x715 mm
OUTPUT: 450 kg / 24h
POWER / VOLTAGE: 1240 W / 230V/50Hz
REFRIGERANT: R290
COOLING SYSTEM: Air cooled

INFO
Type: Granular ice

Suitable storage bin:
BIN 275

10.830 € + V.A.T.

BIN 200

STORAGE CAPACITY

DIMENSIONS: 760x830x1100 mm
CAPACITY: 170 kg

INFO

Suitable for:
SQ 231, SQ 501

1.290 € + V.A.T.

BIN 275

STORAGE CAPACITY

DIMENSIONS: 560x830x1150 mm
CAPACITY: 125 kg

INFO

Suitable for:
GS 450

1.540 € + V.A.T.

BIN 360

STORAGE CAPACITY

DIMENSIONS: 1227x973x1245 mm
CAPACITY: 350 kg

INFO

Suitable for:
SQ 501, SQ 231
Connection kit required

EXTRA

Connection kit 200 € + V.A.T.

2.190 € + V.A.T.



07

INOX

Inox

GREASE COLLECTORS [158]

HAND SINKS HACCP [159]

WASTE CONTAINERS [160]

WALL VENTILATION FUNNELS / FILTERS [160]

SHELVES [161]

RACKS [162]

GLASSWARE CABINETS [164]

WORKING TABLES [165]

TABLES WITH SINK [166]

REFRIGERATED COUNTERS [170]

REFRIGERATED SALAD COUNTERS [178]

CABINETS [179]

HEATING CABINETS [183]

BAR STATIONS [184]

COFFEE STATIONS [185]

GASTRONORME CONTAINERS [186]

INOX GREASE COLLECTORS

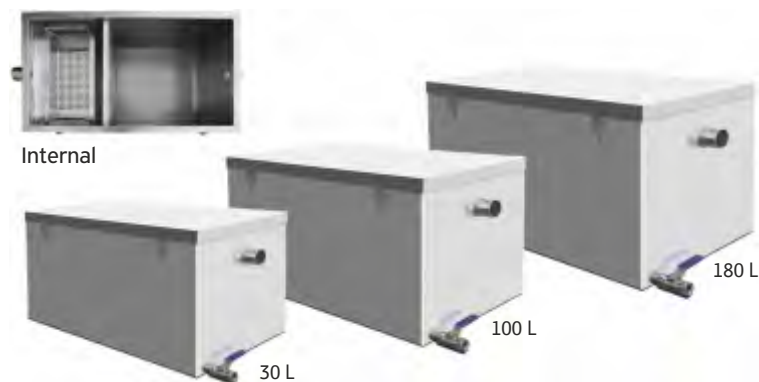

OWS 30

GREASE COLLECTOR 30 lt

DIMENSIONS: 568x318x312 mm
CAPACITY: 30 lt

INFO

Stainless steel construction
Input & output diameter Ø50 mm

185 € + V.A.T.

OWS 100

GREASE COLLECTOR 100 lt

DIMENSIONS: 780x435x476mm
CAPACITY: 100 lt

INFO

Stainless steel construction
Input & output diameter Ø20 mm

265 € + V.A.T.

OWS 180

GREASE COLLECTOR 180 lt

DIMENSIONS: 823x521x627 mm
CAPACITY: 180 lt

INFO

Stainless steel construction
Input & output diameter Ø50 mm

390 € + V.A.T.

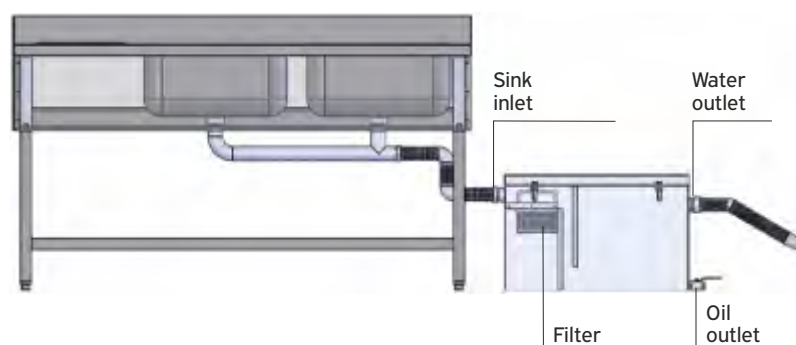

HAND SINKS HACCP



700430

WALL MOUNTED HAND SINK HACCP

DIMENSIONS: 400x340x585 mm (200+385 mm)

INFO

Stainless steel construction
Thermomix valve
Knee operated
Full hydraulic equipment

220 € + V.A.T.



800430

FLOOR MOUNTED HAND SINK HACCP

DIMENSIONS: 400x510x878 mm (850+28 mm)

INFO

Stainless steel construction
Thermomix valve
Foot operated
Full hydraulic equipment

410 € + V.A.T.



INOX WASTE CONTAINERS

900904

WASTE CONTAINER

DIMENSIONS: Ø 380x630 mm

CAPACITY: 60 lt

INFO

Stainless steel construction
Rubber castors

129 € + V.A.T.



900470

WASTE CONTAINER

DIMENSIONS: 700x400x770 mm

CAPACITY: 120 lt

INFO

Stainless steel construction
Rubber castors

298 € + V.A.T.



WALL VENTILATION FUNNELS / FILTERS

FUNNELS

VLR 107 1000x700x450 mm **450 €** + V.A.T.

VLR 157 1500x700x450 mm **540 €** + V.A.T.

VLR 207 2000x700x450 mm **685 €** + V.A.T.

VLR 257 2500x700x450 mm **835 €** + V.A.T.



HF 5538

FILTER

DIMENSIONS: 500x500x38 mm

42 € + V.A.T.



SHELVES



SINGLE SHELVES

RAFW1R63	600x300x350 mm	79 € + V.A.T.	NEW
RAFW1R73	700x300x350 mm	79 € + V.A.T.	NEW
RAFW1R83	800x300x350 mm	85 € + V.A.T.	NEW
RAFW1R103	1000x300x350 mm	95 € + V.A.T.	NEW
RAFW1R123	1200x300x350 mm	108 € + V.A.T.	NEW
RAFW1R143	1400x300x350 mm	125 € + V.A.T.	NEW
RAFW1R153	1500x300x350 mm	135 € + V.A.T.	NEW
RAFW1R163	1600x300x350 mm	150 € + V.A.T.	NEW
RAFW1R183	1800x300x350 mm	165 € + V.A.T.	NEW
RAFW1R203	2000x300x350 mm	190 € + V.A.T.	NEW



DOUBLE SHELVES

RAFW2R63	600x300x700 mm	215 € + V.A.T.	NEW
RAFW2R73	700x300x700 mm	225 € + V.A.T.	NEW
RAFW2R83	800x300x700 mm	245 € + V.A.T.	NEW
RAFW2R103	1000x300x700 mm	255 € + V.A.T.	NEW
RAFW2R123	1200x300x700 mm	265 € + V.A.T.	NEW
RAFW2R143	1400x300x700 mm	275 € + V.A.T.	NEW
RAFW2R153	1500x300x700 mm	290 € + V.A.T.	NEW
RAFW2R163	1600x300x700 mm	305 € + V.A.T.	NEW
RAFW2R183	1800x300x700 mm	315 € + V.A.T.	NEW
RAFW2R203	2000x300x700 mm	330 € + V.A.T.	NEW



TUBULAR SHELVES

VTS 1230	1200x300 mm	95 € + V.A.T.
VTS 1530	1500x300 mm	110 € + V.A.T.
VTS 1240	1200x400 mm	120 € + V.A.T.
VTS 1540	1500x400 mm	135 € + V.A.T.
VTS 1840	1800x400 mm	170 € + V.A.T.

INOX RACKS

SHD640L	600x400x1800 mm	350 € + V.A.T.	NEW
SHD740L	700x400x1800 mm	360 € + V.A.T.	NEW
SHD840L	800x400x1800 mm	370 € + V.A.T.	NEW
SHD940L	900x400x1800 mm	380 € + V.A.T.	NEW
SHD1040L	1000x400x1800 mm	390 € + V.A.T.	NEW
SHD1140L	1100x400x1800 mm	400 € + V.A.T.	NEW
SHD1240L	1200x400x1800 mm	410 € + V.A.T.	NEW
SHD1440L	1400x400x1800 mm	420 € + V.A.T.	NEW
SHD1540L	1500x400x1800 mm	430 € + V.A.T.	NEW
SHD1640L	1600x400x1800 mm	440 € + V.A.T.	NEW
SHD1840L	1800x400x1800 mm	450 € + V.A.T.	NEW
SHD2040L	2000x400x1800 mm	460 € + V.A.T.	NEW

INFO

Stainless steel construction
Easy to assemble
4 perforated stable shelves



SHD650L	600x500x1800 mm	360 € + V.A.T.	NEW
SHD750L	700x500x1800 mm	370 € + V.A.T.	NEW
SHD850L	800x500x1800 mm	380 € + V.A.T.	NEW
SHD950L	900x500x1800 mm	390 € + V.A.T.	NEW
SHD1050L	1000x500x1800 mm	400 € + V.A.T.	NEW
SHD1150L	1100x500x1800 mm	410 € + V.A.T.	NEW
SHD1250L	1200x500x1800 mm	420 € + V.A.T.	NEW
SHD1450L	1400x500x1800 mm	430 € + V.A.T.	NEW
SHD1550L	1500x500x1800 mm	440 € + V.A.T.	NEW
SHD1650L	1600x500x1800 mm	450 € + V.A.T.	NEW
SHD1850L	1800x500x1800 mm	460 € + V.A.T.	NEW
SHD2050L	2000x500x1800 mm	480 € + V.A.T.	NEW

INFO

Stainless steel construction
Easy to assemble
4 perforated stable shelves



COUNTERTOP RACKS

RAFC2087	800x350x700 mm	195 € + V.A.T.	NEW
RAFC2107	1000x350x700 mm	205 € + V.A.T.	NEW
RAFC2127	1200x350x700 mm	225 € + V.A.T.	NEW
RAFC2147	1400x350x700 mm	240 € + V.A.T.	NEW
RAFC2157	1500x350x700 mm	260 € + V.A.T.	NEW
RAFC2167	1600x350x700 mm	280 € + V.A.T.	NEW
RAFC2187	1800x350x700 mm	300 € + V.A.T.	NEW
RAFC2207	2000x350x700 mm	330 € + V.A.T.	NEW

INOX

GLASSWARE CABINETS

GLASSWARE CABINETS

Stainless steel construction, durable shelf, stainless steel sliding doors



500640	600x400x650 mm	360 € + V.A.T.
500840	800x400x650 mm	370 € + V.A.T.
501040	1000x400x650 mm	380 € + V.A.T.
501240	1200x400x650 mm	415 € + V.A.T.
501440	1400x400x650 mm	425 € + V.A.T.
501540	1500x400x650 mm	440 € + V.A.T.
501640	1600x400x650 mm	520 € + V.A.T.
501840	1800x400x650 mm	530 € + V.A.T.
502040	2000x400x650 mm	540 € + V.A.T.

CABINETS

Stainless steel construction, durable shelf, stainless steel sliding doors



167085	600x700x850 mm	590 € + V.A.T.
187085	800x700x850 mm	620 € + V.A.T.
107085	1000x700x850 mm	645 € + V.A.T. NEW
227085	1200x700x850 mm	690 € + V.A.T.
247085	1400x700x850 mm	700 € + V.A.T.
267085	1600x700x850 mm	790 € + V.A.T.
287085	1800x700x850 mm	825 € + V.A.T.
207085	2000x700x850 mm	865 € + V.A.T. NEW

WORKING TABLES

WORKING TABLES

Stainless steel construction, durable shelf, easy to assemble



600670	600x700x850 mm	195 € + V.A.T.
600770	700x700x850 mm	200 € + V.A.T.
600870	800x700x850 mm	275 € + V.A.T.
601070	1000x700x850 mm	285 € + V.A.T.
601270	1200x700x850 mm	305 € + V.A.T.
601470	1400x700x850 mm	340 € + V.A.T.
601570	1500x700x850 mm	345 € + V.A.T.
601670	1600x700x850 mm	390 € + V.A.T.
601870	1800x700x850 mm	400 € + V.A.T.
602070	2000x700x850 mm	415 € + V.A.T.

600660	600x600x850 mm	176 € + V.A.T.
600760	700x600x850 mm	186 € + V.A.T.
600860	800x600x850 mm	194 € + V.A.T.
601060	1000x600x850 mm	205 € + V.A.T.
601260	1200x600x850 mm	215 € + V.A.T.
601460	1400x600x850 mm	225 € + V.A.T.
601560	1500x600x850 mm	235 € + V.A.T.
601660	1600x600x850 mm	250 € + V.A.T.
601860	1800x600x850 mm	275 € + V.A.T.
602060	2000x600x850 mm	295 € + V.A.T.

INOX TABLES WITH SINK

607095

TABLE WITH SINGLE SINK

DIMENSIONS: 600x700x950 mm
SINK DIMENSIONS: 400x500x250 mm
SINKS: 1

INFO

Stainless steel construction
Durable shelf
Backsplash
Easy to assemble

495 € + V.A.T.



1207095

TABLE WITH SINGLE SINK

DIMENSIONS: 1200x700x950 mm
SINK DIMENSIONS: 1060x500x350 mm
SINKS: 1

INFO

Stainless steel construction
Durable shelf
Backsplash
Easy to assemble

650 € + V.A.T.



107095 L

TABLE WITH SINGLE SINK

DIMENSIONS: 1000x700x950 mm
SINK DIMENSIONS: 400x500x250 mm
SINKS: 1 left

INFO

Stainless steel construction
Durable shelf
Backsplash
Easy to assemble

620 € + V.A.T.



107095 R

TABLE WITH SINGLE SINK

DIMENSIONS: 1000x700x950 mm
SINK DIMENSIONS: 400x500x250 mm
SINKS: 1 right

INFO

Stainless steel construction
Durable shelf
Backsplash
Easy to assemble

620 € + V.A.T.



127095 L

TABLE WITH SINGLE SINK

DIMENSIONS: 1200x700x950 mm
SINK DIMENSIONS: 500x500x250 mm
SINKS: 1 left

INFO

Stainless steel construction
Durable shelf
Backsplash
Easy to assemble

680 € + V.A.T.



127095 R

TABLE WITH SINGLE SINK

DIMENSIONS: 1200x700x950 mm
SINK DIMENSIONS: 500x500x250 mm
SINKS: 1 right

INFO

Stainless steel construction
Durable shelf
Backsplash
Easy to assemble

680 € + V.A.T.



167095 L

TABLE WITH DOUBLE SINK

DIMENSIONS: 1600x700x950 mm
SINK DIMENSIONS: 400x500x250 mm
SINKS: 2 left

INFO

Stainless steel construction
Durable shelf
Backsplash
Easy to assemble

760 € + V.A.T.



167095 R

TABLE WITH DOUBLE SINK

DIMENSIONS: 1600x700x950 mm
SINK DIMENSIONS: 400x500x250 mm
SINKS: 2 right

INFO

Stainless steel construction
Durable shelf
Backsplash
Easy to assemble

760 € + V.A.T.

187095 L

TABLE WITH DOUBLE SINK

DIMENSIONS: 1800x700x950 mm
SINK DIMENSIONS: 500x500x250 mm
SINKS: 2 left

INFO

Stainless steel construction
Durable shelf
Backsplash
Easy to assemble

870 € + V.A.T.

187095 R

TABLE WITH DOUBLE SINK

DIMENSIONS: 1800x700x950 mm
SINK DIMENSIONS: 500x500x250 mm
SINKS: 2 right

INFO

Stainless steel construction
Durable shelf
Backsplash
Easy to assemble

870 € + V.A.T.

INOX TABLES WITH SINK



667095 DS

TABLE WITH SINGLE SINK

DIMENSIONS: 600x700x950 mm
SINK DIMENSIONS: 400x500x250 mm
SINKS: 1

INFO

Stainless steel construction
Backsplash

650 € + V.A.T.



1207095 DS

TABLE WITH SINGLE SINK

DIMENSIONS: 1200x700x950 mm
SINK DIMENSIONS: 1060x500x350 mm
SINKS: 1

INFO

Stainless steel construction
Backsplash

960 € + V.A.T.



107095 LDS

TABLE WITH SINGLE SINK

DIMENSIONS: 1000x700x950 mm
SINK DIMENSIONS: 400x500x250 mm
SINKS: 1 left

INFO

Stainless steel construction
Backsplash

870 € + V.A.T.



107095 RDS

TABLE WITH SINGLE SINK

DIMENSIONS: 1000x700x950 mm
SINK DIMENSIONS: 400x500x250 mm
SINKS: 1 right

INFO

Stainless steel construction
Backsplash

870 € + V.A.T.

127095 LDS

TABLE WITH SINGLE SINK

DIMENSIONS: 1200x700x950 mm
SINK DIMENSIONS: 500x500x250 mm
SINKS: 1 left

INFO

Stainless steel construction
Backsplash

940 € + V.A.T.

127095 RDS

TABLE WITH SINGLE SINK

DIMENSIONS: 1200x700x950mm
SINK DIMENSIONS: 500x500x250mm
SINKS: 1 right

INFO

Stainless steel construction
Backsplash

940 € + V.A.T.



167095 LDS

TABLE WITH DOUBLE SINK

DIMENSIONS: 1600x700x950mm
SINK DIMENSIONS: 400x500x250mm
SINKS: 2 left

INFO
Stainless steel construction
Backsplash

1.270 € + V.A.T.

167095 RDS

TABLE WITH DOUBLE SINK

DIMENSIONS: 1600x700x950mm
SINK DIMENSIONS: 400x500x250mm
SINKS: 2 right

INFO
Stainless steel construction
Backsplash

1.270 € + V.A.T.

187095 LDS

TABLE WITH DOUBLE SINK

DIMENSIONS: 1800x700x950mm
SINK DIMENSIONS: 500x500x250mm
SINKS: 2 left

INFO
Stainless steel construction
Backsplash

1.390 € + V.A.T.

187095 RDS

TABLE WITH DOUBLE SINK

DIMENSIONS: 1800x700x950mm
SINK DIMENSIONS: 500x500x250mm
SINKS: 2 right

INFO
Stainless steel construction
Backsplash

1.390 € + V.A.T.



INOX

REFRIGERATED COUNTERS



312100 Snack

REFRIGERATED COUNTER

DIMENSIONS: 1360x600x860 mm
CAPACITY: 215 lt
POWER: 180 Watt
TEMPERATURE: +1°C up to +8°C
COOLING: Ventilated
DEFROST: Automatic
REFRIGERANT: R290
DOORS: 2 (42x63 cm)
GRIDS: 2 (43x32.5 cm)

INFO

Stainless steel construction
Self reversed doors up to 90°
Plastic laminated grids
Stainless steel adjustable feet
Right side compressor
60 mm insulation

1.620 € + V.A.T.



313100 Snack

REFRIGERATED COUNTER

DIMENSIONS: 1795x600x860 mm
CAPACITY: 333 lt
POWER: 270 Watt
TEMPERATURE: +1°C up to +8°C
COOLING: Ventilated
DEFROST: Automatic
REFRIGERANT: R290
DOORS: 3 (42x63 cm)
GRIDS: 3 (43x32.5 cm)

INFO

Stainless steel construction
Self reversed doors up to 90°
Plastic laminated grids
Stainless steel adjustable feet
Right side compressor
60 mm insulation

1.790 € + V.A.T.

314100 Snack

REFRIGERATED COUNTER

DIMENSIONS: 2230x600x860 mm
CAPACITY: 451 lt
POWER: 310 Watt
TEMPERATURE: +1°C up to +8°C
COOLING: Ventilated
DEFROST: Automatic
REFRIGERANT: R290
DOORS: 4 (42x63 cm)
GRIDS: 4 (43x32.5 cm)

INFO

Stainless steel construction
Self reversed doors up to 90°
Plastic laminated grids
Stainless steel adjustable feet
Right side compressor
60 mm insulation





312100

REFRIGERATED COUNTER

DIMENSIONS: 1360x700x860 mm
 CAPACITY: 260 lt
 POWER: 180 Watt
 TEMPERATURE: +1°C up to +8°C
 COOLING: Ventilated
 DEFROST: Automatic
 REFRIGERANT: R290
 DOORS: 2 (42x63 cm)
 GRIDS: 2 (53x32.5 cm)

INFO

Stainless steel construction
 Self reversed doors up to 90°
 Plastic laminated grids
 Stainless steel adjustable feet
 Right side compressor
 60 mm insulation

1.790 € + V.A.T.



313100

REFRIGERATED COUNTER

DIMENSIONS: 1795x700x860 mm
 CAPACITY: 406 lt
 POWER: 270 Watt
 TEMPERATURE: +1°C up to +8°C
 COOLING: Ventilated
 DEFROST: Automatic
 REFRIGERANT: R290
 DOORS: 3 (42x63 cm)
 GRIDS: 3 (53x32.5 cm)

INFO

Stainless steel construction
 Self reversed doors up to 90°
 Plastic laminated grids
 Stainless steel adjustable feet
 Right side compressor
 60 mm insulation

1.890 € + V.A.T.

314100

REFRIGERATED COUNTER

DIMENSIONS: 2230x700x860 mm
 CAPACITY: 550 lt
 POWER: 310 Watt
 TEMPERATURE: +1°C up to +8°C
 COOLING: Ventilated
 DEFROST: Automatic
 REFRIGERANT: R290
 DOORS: 4 (42x63 cm)
 GRIDS: 4 (53x32.5 cm)

INFO

Stainless steel construction
 Self reversed doors up to 90°
 Plastic laminated grids
 Stainless steel adjustable feet
 Right side compressor
 60 mm insulation

2.360 € + V.A.T.



Also available in version with embedded sink of dimensions 25x40x20 cm.

GAL2100TN

DIMENSIONS: 1360x700x860 mm

2.305 € + V.A.T.

GAL3100TN

DIMENSIONS: 1795x700x860 mm

2.740 € + V.A.T.

GAL4100TN

DIMENSIONS: 2230x700x860 mm

3.280 € + V.A.T.

INOX REFRIGERATED COUNTERS



S 901

REFRIGERATED COUNTER

DIMENSIONS EXT.: 900x700x870mm

DIMENSIONS INT.: 830x595x500mm

CAPACITY: 240 lt

COOLING: Static

DEFROST: Manual

REFRIGERANT: R290

TEMPERATURE: +1°C / +8°C

POWER: 210 Watt

DOORS: 2

GRIDS:2

INFO

Stainless steel construction

1.115 € + V.A.T.



312140

REFRIGERATED COUNTER

DIMENSIONS: 1360x700x860 mm
CAPACITY: 280 lt
POWER: 180 Watt
TEMPERATURE: +1°C up to +8°C
THERMOSTAT: Electronic
COOLING: Ventilated
DEFROST: Automatic
REFRIGERANT: R290
DRAWERS: 4 GN ½

INFO

Stainless steel construction
Stainless steel adjustable feet
Right side compressor
60 mm insulation



Filterer
Top Quality

2.760 € + V.A.T.



313140

REFRIGERATED COUNTER

DIMENSIONS: 1795x700x860 mm
CAPACITY: 415 lt
POWER: 270 Watt
TEMPERATURE: +1°C up to +8°C
THERMOSTAT: Electronic
COOLING: Ventilated
DEFROST: Automatic
REFRIGERANT: R290
DOORS: 1 (42x63 cm)
DRAWERS: 4 GN ½

INFO

Stainless steel construction
Stainless steel adjustable feet
Right side compressor
60 mm insulation

2.940 € + V.A.T.

INOX

REFRIGERATED COUNTERS



313160/650

REFRIGERATED COUNTER

DIMENSIONS: 1795x700x650 mm
POWER: 270 Watt
TEMPERATURE: +1°C / +8°C
COOLING: Ventilated
DEFROST: Automatic
REFRIGERANT: R290
DRAWERS: 6

INFO

Stainless steel construction
Stainless steel adjustable feet
Right side compressor
60 mm insulation

2.990 € + V.A.T.

314180/650

REFRIGERATED COUNTER

DIMENSIONS: 2230x700x650 mm
POWER: 310 Watt
TEMPERATURE: +1°C / +8°C
COOLING: Ventilated
DEFROST: Automatic
REFRIGERANT: R290
DRAWERS: 8

INFO

Stainless steel construction
Stainless steel adjustable feet
Right side compressor
60 mm insulation

3.950 € + V.A.T.

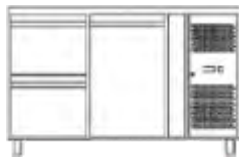

312140

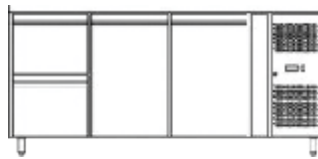

313140

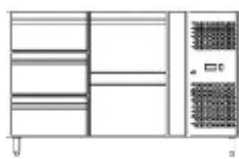
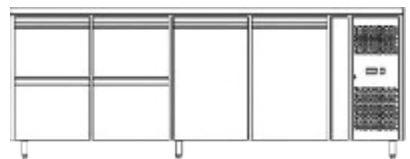
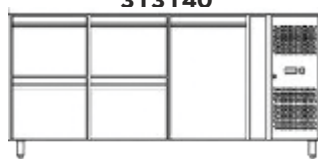
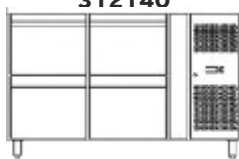
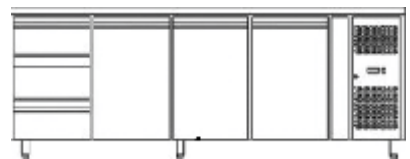
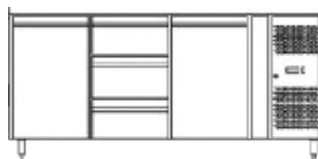
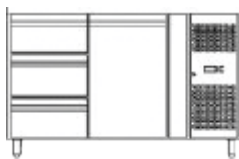
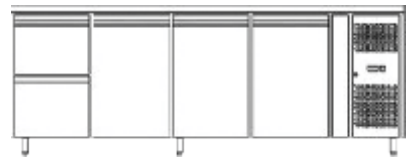

313160/650

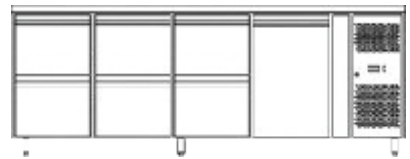
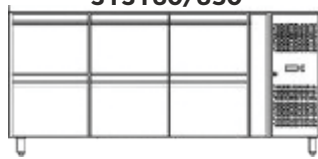

314180/650

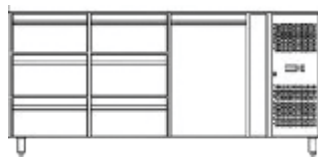

FREEZING COUNTERS



312100 BT

FREEZING COUNTER

DIMENSIONS: 1360x700x860 mm
CAPACITY: 260 lt
POWER: 538 Watt
TEMPERATURE: -18°C up to -22°C
COOLING: Ventilated
DEFROST: Automatic
REFRIGERANT: R290
DOORS: 2 (42x63 cm)
GRIDS: 2 (53x32.5 cm)

INFO

Stainless steel construction
Self reversed doors up to 90°
Plastic laminated adjustable grids
Stainless steel adjustable feet
Right side compressor
60 mm insulation

1.990 € + V.A.T.



313100 BT

FREEZING COUNTER

DIMENSIONS: 1795x700x860 mm
CAPACITY: 403 lt
POWER: 580 Watt
TEMPERATURE: -18°C up to -22°C
COOLING: Ventilated
DEFROST: Automatic
REFRIGERANT: R290
DOORS: 3 (42x63 cm)
GRIDS: 3 (53x32.5 cm)

INFO

Stainless steel construction
Self reversed doors up to 90°
Plastic laminated adjustable grids
Stainless steel adjustable feet
Right side compressor
60 mm insulation

2.150 € + V.A.T.



314100 BT

FREEZING COUNTER

DIMENSIONS: 2230x700x860 mm
CAPACITY: 545 lt
POWER: 680 Watt
TEMPERATURE: -18°C up to -22°C
COOLING: Ventilated
DEFROST: Automatic
REFRIGERANT: R290
DOORS: 4 (42x63 cm)
GRIDS: 4 (53x32.5 cm)

INFO

Stainless steel construction
Self reversed doors up to 90°
Plastic laminated adjustable grids
Stainless steel adjustable feet
Right side compressor
60 mm insulation

2.500 € + V.A.T.

INOX

REFRIGERATED PIZZA COUNTERS



150580 PZ

REFRIGERATED PIZZA COUNTER

DIMENSIONS: 1505x800x1000 mm
CAPACITY: 360 lt
POWER: 290 Watt
TEMPERATURE: +2°C up to +8°C
COOLING: Ventilated
DEFROST: Automatic
REFRIGERANT: R290
DOORS: 2

INFO

Stainless steel construction
Self reversed doors up to 90°
Plastic laminated adjustable grids
Right side compressor

2.290 € + V.A.T.



151080 PZ

REFRIGERATED PIZZA COUNTER

DIMENSIONS: 1510x800x1000 mm
CAPACITY: 165 lt
POWER: 290 Watt
TEMPERATURE: +2°C up to +8°C
COOLING: Ventilated
DEFROST: Automatic
REFRIGERANT: R290
DOORS: 1
DOUGH DRAWERS: 7 (485x770x75 mm)

INFO

Stainless steel construction
Self reversed doors up to 90°
Plastic laminated adjustable grids
Right side compressor

2.630 € + V.A.T.

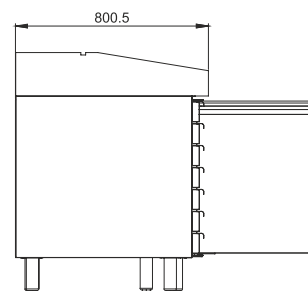
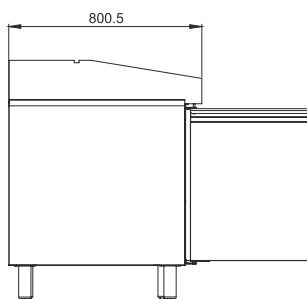
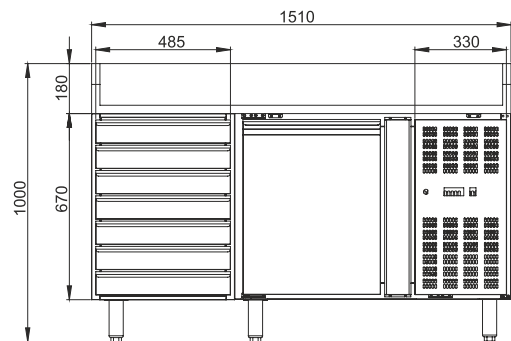
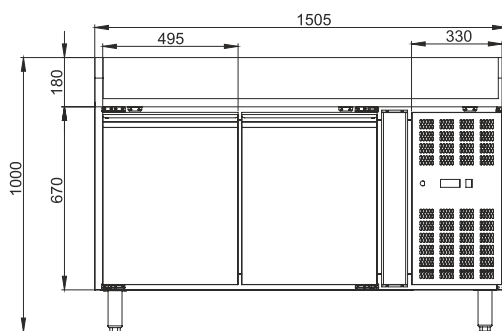



202080 PZ

REFRIGERATED PIZZA COUNTER

DIMENSIONS: 2020x800x1000 mm
 CAPACITY: 360 lt
 POWER: 290 Watt
 TEMPERATURE: +2°C up to +8°C
 COOLING: Ventilated
 DEFROST: Automatic
 REFRIGERANT: R290
 DOORS: 2
 DOUGH DRAWERS: 7 (485x770x75 mm)

INFO

Stainless steel construction
 Self reversed doors up to 90°
 Plastic laminated adjustable grids
 Right side compressor
 60 mm insulation

2.940 € + V.A.T.

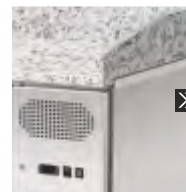

» GRANITE WORKTOP

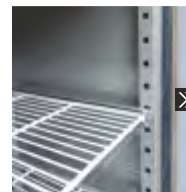

» ADJUSTABLE SHELVES



» DOUGH DRAWERS



INOX

REFRIGERATED SALAD COUNTERS



S 900

REFRIGERATED SALAD COUNTER WITH LID

DIMENSIONS EXT.: 900x700x870 mm

DIMENSIONS INT.: 830x595x500 mm

CAPACITY: 240 lt

COOLING: Static

DEFROST: Manual

REFRIGERANT: R290

TEMPERATURE: +1°C up to +8°C

POWER: 210 Watt

DOORS: 2

GRIDS: 2

INFO

Stainless steel construction

With lid

1.025 € + V.A.T.

CABINETS



220600

COOLING CABINET

DIMENSIONS EXT.: 680x810x2010 mm
DIMENSIONS INT.: 564x680x1394 mm
CAPACITY: 475 lt
POWER: 300 Watt
TEMPERATURE: +1°C up to +8°C
COOLING: Ventilated
DEFROST: Automatic
REFRIGERANT: R290
DOORS: 1
GRIDS: 3

INFO

Stainless steel construction
Self reversed doors up to 90°
Plastic laminated adjustable grids
Stainless steel adjustable feet
60 mm insulation
Electronic thermostat
Led illumination

1.950 € + V.A.T.



PA 800TN

COOLING CABINET

DIMENSIONS EXT.: 740x990x2010 mm
DIMENSIONS INT.: 624x845x1390 mm
CAPACITY: 750 lt & trays 60x40cm
POWER: 350 Watt / 230 V / 50 Hz
TEMPERATURE: +1°C up to +8°C
COOLING: Ventilated
DEFROST: Automatic
REFRIGERANT: R290
DOORS: 1
GRIDS: 3

INFO

Stainless steel construction
Lock
Electronic thermostat
Led illumination

2.150 € + V.A.T.



211200

COOLING CABINET

DIMENSIONS EXT.: 1340x810x2010 mm
DIMENSIONS INT.: 1120x680x1394 mm
CAPACITY: 1040 lt
POWER: 380 Watt
TEMPERATURE: +1°C up to +8°C
COOLING: Ventilated
DEFROST: Automatic
REFRIGERANT: R290
DOORS: 2
GRIDS: 3+3

INFO

Stainless steel construction
Self reversed doors up to 90°
Plastic laminated adjustable grids
Stainless steel adjustable feet
60 mm insulation
Electronic thermostat
Led illumination

2.690 € + V.A.T.

INOX CABINETS



100600

FREEZING CABINET

DIMENSIONS EXT.: 680x810x2010 mm
DIMENSIONS INT.: 564x680x1394 mm
CAPACITY: 475 lt
POWER: 585 Watt
TEMPERATURE: 0°C up to -18°C
COOLING: Ventilated
DEFROST: Automatic
REFRIGERANT: R290
DOORS: 1
GRIDS: 3

INFO

Stainless steel construction
Self reversed doors up to 90°
Plastic laminated adjustable grids
Stainless steel adjustable feet
60 mm insulation
Electronic thermostat
Led illumination

2.250 € + V.A.T.

101200

FREEZING CABINET

DIMENSIONS EXT.: 1340x810x2010 mm
DIMENSIONS INT.: 1112x680x1394 mm
CAPACITY: 1040 lt
POWER: 760 Watt
TEMPERATURE: 0°C up to -18°C
COOLING: Ventilated
DEFROST: Automatic
REFRIGERANT: R290
DOORS: 2
GRIDS: 3+3

INFO

Stainless steel construction
Self reversed doors up to 90°
Plastic laminated adjustable grids
Stainless steel adjustable feet
60 mm insulation
Electronic thermostat
Led illumination

2.980 € + V.A.T.



PA 800BT

FREEZING CABINET

DIMENSIONS EXT.: 740x990x2010 mm
DIMENSIONS INT.: 624x845x1390 mm
CAPACITY: 750 lt & trays 60x40cm
POWER: 660 Watt / 230 V / 50 Hz
TEMPERATURE: -18°C up to -22°C
COOLING: Ventilated
DEFROST: Automatic
REFRIGERANT: R290
DOORS: 1
GRIDS: 3

INFO

Stainless steel construction
Lock
Electronic thermostat
Led illumination

2.690 € + V.A.T.



VFR 400SS

COOLING CABINET

DIMENSIONS EXT.: 600x585x1850 mm
CAPACITY: 357 lt
POWER: 300 Watt
TEMPERATURE: +1°C up to +5°C
COOLING: Static with auxiliary fan
DEFROST: Manual
REFRIGERANT: R600a
DOORS: 1
GRIDS: 4

INFO

Stainless steel construction
Lock
Electronic thermostat
Led illumination

1.255 € + V.A.T.



VFR 600SS

COOLING CABINET

DIMENSIONS EXT.: 777x695x1890 mm
CAPACITY: 543 lt
POWER: 442 Watt
TEMPERATURE: +1°C up to +5°C
COOLING: Static with auxiliary fan
DEFROST: Manual
REFRIGERANT: R600a
DOORS: 1
GRIDS: 4

INFO

Stainless steel construction
Lock
Electronic thermostat
Led illumination

1.325 € + V.A.T.



VFD 400SS

FREEZING CABINET

DIMENSIONS EXT.: 600x585x1850 mm
CAPACITY: 304 lt
POWER: 384 Watt
TEMPERATURE: -18°C up to -20°C
COOLING: Static
DEFROST: Manual
REFRIGERANT: R290
DOORS: 1
SHELVES: 6 refrigerated

INFO

Stainless steel construction
Lock
Electronic thermostat
Led illumination

1.185 € + V.A.T.

VFD 600SS

FREEZING CABINET

DIMENSIONS EXT.: 777x695x1890 mm
CAPACITY: 538 lt
POWER: 450 Watt
TEMPERATURE: -18°C up to -20°C
COOLING: Static
DEFROST: Manual
REFRIGERANT: R290
DOORS: 1
SHELVES: 6 refrigerated

INFO

Stainless steel construction
Lock
Electronic thermostat
Led illumination

1.395 € + V.A.T.

INOX CABINETS

VFD 600SS/DUAL

COOLING & FREEZING CABINET

DIMENSIONS: 756x823x1990 mm

CAPACITY: 525 ltr

POWER: 485 W

TEMPERATURE: -18°C up to +5°C

COOLING: Ventilated

DEFROST: Automatic

REFRIGERANT: R290

DOORS: 1

SHELVES: 4

INFO

Stainless steel construction

Lock

Electronic thermostat

1.870 € + V.A.T.

NEW



HEATING CABINETS



DNC 1 1 DG

HEATING CABINET WITH CASTORS

DIMENSIONS EXT.: 790x970x1810 mm
DIMENSIONS INT.: 540x680x1380 mm
TEMPERATURE: up to 80°C
THERMOSTAT: Analog
POWER: 2.620 Watt / 230 V / 50 Hz
GRIDS: 11 (65X53cm)

INFO

Stainless steel construction
Castors
Heated water pan
Hot air circulation fan
Grids are not included

2.750 € + V.A.T.



DNC 2 1 DG

HEATING CABINET WITH CASTORS

DIMENSIONS EXT.: 1540x970x1810 mm
DIMENSIONS INT.: 1350x680x1380 mm
TEMPERATURE: up to 80°C
THERMOSTAT: Analog
POWER: 2.620 Watt / 230 V / 50 Hz
GRIDS: 22 (65X53cm)

INFO

Stainless steel construction
Castors
Heated water pan
Hot air circulation fan
Grids are not included

3.990 € + V.A.T.

INOX BAR STATION



GN3 100 TN-QTS

ΨΥΧΟΜΕΝΟ BAR STATION

DIMENSIONS: 1800x700x850+100 mm

POWER: 393 Watt

TEMPERATURE: +1°C up to +8°C

COOLING: Ventilated

DEFROST: Automatic

REFRIGERANT: R134/R290

DOORS: 1

DRAWERS: 2 GN 2/3

INFO

Stainless steel construction

Self reversed doors up to 90°

Sink 27x33 cm

Pitcher rinser, bottle holder, ice container, blender shelf

Stainless steel adjustable feet

Right side compressor



4.890 € + V.A.T.

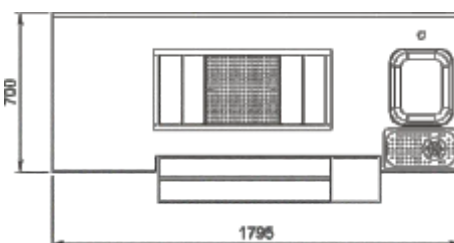
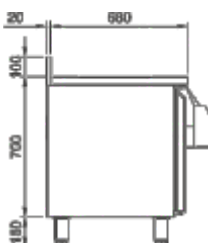
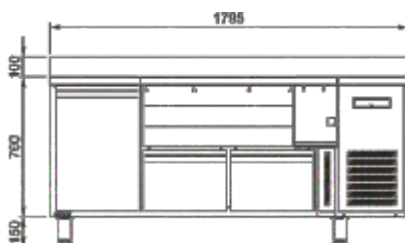

COFFEE STATION



150700

COFFEE STATION

DIMENSIONS: 1500x600x1050+100 mm

INFO

Stainless steel construction
Stainless steel adjustable feet
Drawers for coffee, hold drawer, storage space

980 € + V.A.T.

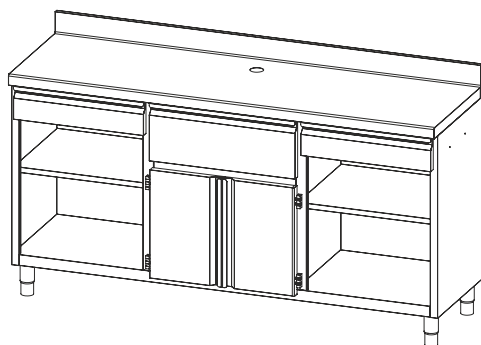

200700

COFFEE STATION

DIMENSIONS: 2000x600x1050+100 mm

INFO

Stainless steel construction
Stainless steel adjustable feet
Drawers for coffee, hold drawer, storage space

1.150 € + V.A.T.

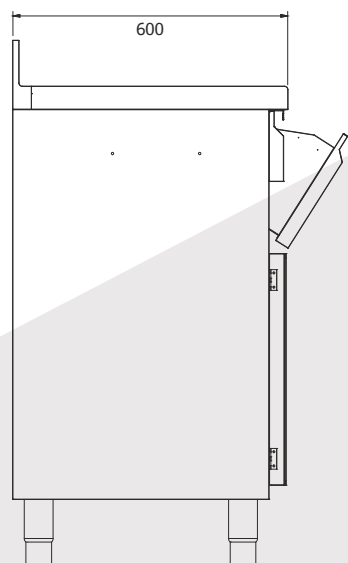
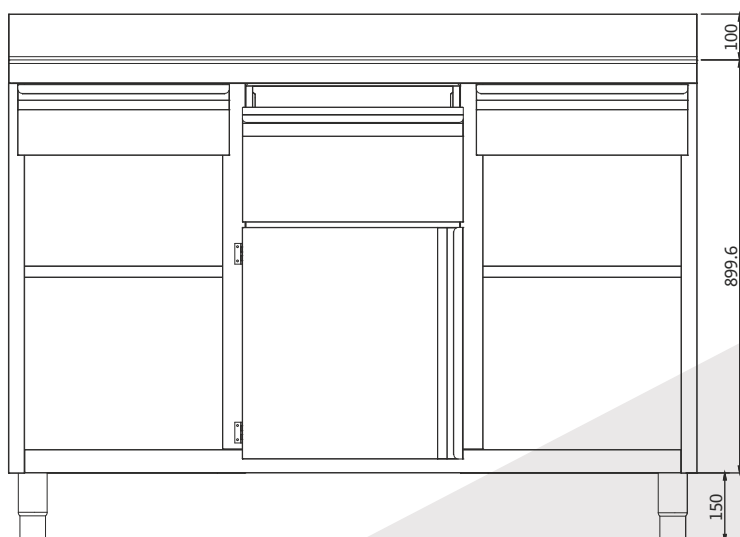

INOX

GASTRONORME CONTAINERS

CODE	DESCRIPTION	THICKNESS	LT
------	-------------	-----------	----

STAINLESS STEEL AISI201 53x65 cm

GN 2120	GN 2/1 20 mm depth	0,70 mm	5,00
GN 2140	GN 2/1 40 mm depth	0,70 mm	10,00
GN 2165	GN 2/1 65 mm depth	0,80 mm	18,50
GN 21100	GN 2/1 100 mm depth	0,80 mm	28,50
GN 21150	GN 2/1 150 mm depth	0,80 mm	42,50
GN 21200	GN 2/1 200 mm depth	0,80 mm	57,50

**STAINLESS STEEL AISI201 53x32,5 cm**

GN 1120	GN 1/1 20 mm depth	0,60 mm	2,50
GN 1140	GN 1/1 40 mm depth	0,60 mm	5,00
GN 1165	GN 1/1 65 mm depth	0,60 mm	9,00
GN 11100	GN 1/1 100 mm depth	0,60 mm	14,00
GN 11150	GN 1/1 150 mm depth	0,60 mm	21,00
GN 11200	GN 1/1 200 mm depth	0,70 mm	28,00

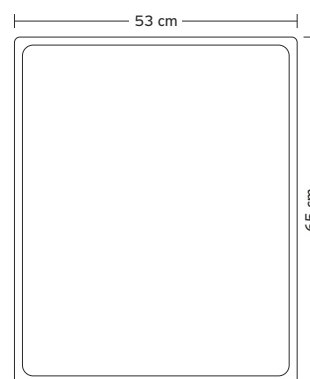
**STAINLESS STEEL AISI201 35,4x32,5 cm**

GN 2320	GN 2/3 20 mm depth	0,60 mm	1,50
GN 2340	GN 2/3 40 mm depth	0,60 mm	3,00
GN 2365	GN 2/3 65 mm depth	0,60 mm	5,50
GN 23100	GN 2/3 100 mm depth	0,60 mm	9,00
GN 23150	GN 2/3 150 mm depth	0,70 mm	13,00
GN 23200	GN 2/3 200 mm depth	0,70 mm	18,00

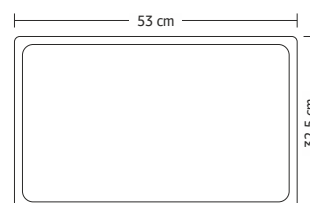
**STAINLESS STEEL AISI201 32,5x26,5 cm**

GN 1220	GN 1/2 20 mm depth	0,60 mm	1,25
GN 1240	GN 1/2 40 mm depth	0,60 mm	2,00
GN 1265	GN 1/2 65 mm depth	0,60 mm	4,00
GN 12100	GN 1/2 100 mm depth	0,60 mm	6,50
GN 12150	GN 1/2 150 mm depth	0,60 mm	5,50
GN 12200	GN 1/2 200 mm depth	0,70 mm	12,50

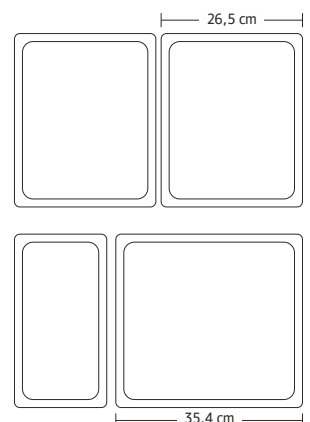
**STAINLESS STEEL AISI201 32,5x17,6 cm**

GN 1320	GN 1/3 20 mm depth	0,60 mm	0,75
GN 1340	GN 1/3 40 mm depth	0,60 mm	1,50
GN 1365	GN 1/3 65 mm depth	0,60 mm	2,50
GN 13100	GN 1/3 100 mm depth	0,60 mm	4,00
GN 13150	GN 1/3 150 mm depth	0,60 mm	5,70
GN 13200	GN 1/3 200 mm depth	0,70 mm	7,80

CODE	DESCRIPTION	THICKNESS	LT
------	-------------	-----------	----

STAINLESS STEEL AISI201 26,5x16,2 cm

GN 1420	GN 1/4 20 mm depth	0,60 mm	0,50
GN 1440	GN 1/4 40 mm depth	0,60 mm	1,20
GN 1465	GN 1/4 65 mm depth	0,60 mm	1,80
GN 14100	GN 1/4 100 mm depth	0,60 mm	2,80
GN 14150	GN 1/4 150 mm depth	0,70 mm	4,00
GN 14200	GN 1/4 200 mm depth	0,70 mm	5,50

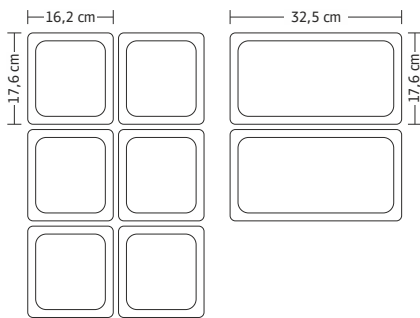

STAINLESS STEEL AISI201 17,6x16,2 cm

GN 1665	GN 1/6 65 mm depth	0,60 mm	0,10
GN 16100	GN 1/6 100 mm depth	0,60 mm	1,60
GN 16150	GN 1/6 150 mm depth	0,70 mm	2,40
GN 16200	GN 1/6 200 mm depth	0,70 mm	3,40

STAINLESS STEEL AISI201 17,6x10,8 cm

GN 1965	GN 1/9 65 mm depth	0,70 mm	0,60
GN 19100	GN 1/9 100 mm depth	0,70 mm	1,00

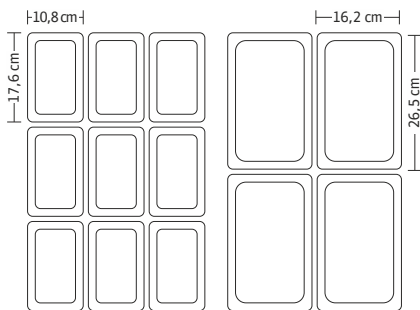

STAINLESS STEEL AISI201

GNL 21	GN 2/1 LID	0,70 mm	
GNL 11	GN 1/1 LID	0,60 mm	
GNL 23	GN 2/3 LID	0,60 mm	
GNL 12	GN 1/2 LID	0,60 mm	
GNL 13	GN 1/3 LID	0,60 mm	
GNL 14	GN 1/4 LID	0,60 mm	
GNL 16	GN 1/6 LID	0,60 mm	
GNL 19	GN 1/9 LID	0,60 mm	

08

BLAST
CHILLERS
SHOCK
FREEZERS



Blast Chillers Shock Freezers

BLAST CHILLERS / SHOCK FREEZERS

BC5T

BLAST CHILLER / SHOCK FREEZER

DIMENSIONS : 800x800x1000 mm
CAPACITY: 5 GN 1/1 ñ 5 trays 40x60 cm
BLAST CHILLING:
At 90': +75°C → +3°C 25 kg
BLAST FREEZING:
At 240': +75°C → -18°C 12,5 kg
LEVELS DISTANCE: 75 mm
INSULATION: 85 mm
POWER: 925 watt
DEFROST: Automatic with resistors
REFRIGERANT: R290

INFO

Digital control panel
LCD touch screen
Single point core probe

5.490 € + V.A.T.



BC10T

BLAST CHILLER / SHOCK FREEZER

DIMENSIONS : 800x800x1385 mm
CAPACITY: 10 GN 1/1 ñ 10 trays 40x60 cm
BLAST CHILLING:
At 90': +75°C --» +3°C 50kg
BLAST FREEZING:
At 240': +75°C --» -18°C 25 kg
LEVELS DISTANCE: 75 mm
INSULATION: 85 mm
POWER: 1556 watt
DEFROST: Automatic with resistors
REFRIGERANT: R290

INFO

Digital control panel
LCD touch screen
Single point core probe

7.950 € + V.A.T.





BC 15T

BLAST CHILLER / SHOCK FREEZER

DIMENSIONS : 800x800x1920 mm
CAPACITY: 15 GN 1/1 ó 15 trays 40x60 cm
BLAST CHILLING:
At 90': +75°C → +3°C 75kg
BLAST FREEZING:
At 240': +75°C → -18°C 37,5 kg
LEVELS DISTANCE: 75 mm
INSULATION: 85 mm
POWER: 1620 watt
DEFROST: Automatic with resistors
REFRIGERANT: R290

INFO

Digital control panel
LCD touch screen
Single point core probe

9.450 € + V.A.T.

09

COOKING

Kitchen equipment series 70

COUNTERTOP ELECTRIC STOVES [194]

COUNTERTOP GAS STOVES [195]

COUNTERTOP ELECTRIC FRYERS [196]

BAIN MARIE & NEUTRALS [197]

ELECTRIC GRIDDLE PLATES [198]

ELECTRIC CHROMIUM GRIDDLE PLATES [199]

GAS GRIDDLE PLATES [200]

GAS CHROMIUM GRIDDLE PLATES [201]

ELECTRIC WATER GRILLS [202]

ELECTRIC & GAS RANGES WITH OVEN [202]

FLOOR MOUNTED GAS FRYERS [203]

FLOOR MOUNTED ELECTRIC & GAS PASTA COOKERS [204]

ELECTRIC & GAS TILTING BRATT PANS [204]

FLOOR MOUNTED INDUCTION COOKERS [205]

GAS FREE STANDING RANGES [205]

COUNTERTOP ELECTRIC STOVES

9705000

ELECTRIC STOVE

DIMENSIONS: 400x700x250 mm
POWER: 2 x 2,6 Kw/400V
PLATES: Electric
PLATE DIAMETER: 220 mm

825 € + V.A.T.



9706000

ELECTRIC STOVE

DIMENSIONS: 800x700x250 mm
POWER: 4 x 2,6 Kw/400V
PLATES: Electric
PLATE DIAMETER: 220 mm

1.225 € + V.A.T.



9707000

ELECTRIC STOVE

DIMENSIONS: 1200x700x250 mm
POWER: 6 x 2,6 Kw/400V
PLATES: Electric
PLATE DIAMETER: 220 mm

1.658 € + V.A.T.



9705500

ELECTRIC STOVE

DIMENSIONS: 400x700x250 mm
POWER: 2 x 2,5 Kw/400V
PLATES: Ceramic
PLATE DIAMETER: 225 mm

1.087 € + V.A.T.



9706500

ELECTRIC STOVE

DIMENSIONS: 800x700x250 mm
POWER: 4 x 2,5 Kw/400V
PLATES: Ceramic
PLATE DIAMETER: 225 mm

1.912 € + V.A.T.



COUNTERTOP GAS STOVES

made in
POLAND 



9705230

GAS STOVE

DIMENSIONS: 400x700x250 mm

POWER: 1x3,5 + 1x7 Kw

PLATES: Gas

INFO

Pilot flame

Anti leakage safety device

1.100 € + V.A.T.



9706330

GAS STOVE

DIMENSIONS: 800x700x250 mm

POWER: 2x5 + 2x7 Kw

PLATES: Gas

INFO

Pilot flame

Anti leakage safety device

1.857 € + V.A.T.



9707230

GAS STOVE

DIMENSIONS: 1200x700x250 mm

POWER: 1x3,5 + 2x5 + 2x7 + 1x9 Kw

PLATES: Gas

INFO

Pilot flame

Anti leakage safety device

2.421 € + V.A.T.

COUNTERTOP ELECTRIC FRYERS

9725000

ELECTRIC FRYER

DIMENSIONS: 400x700x250 mm
CAPACITY: 10 lt
POWER: 9 Kw / 400 V
BASKET DIMENSIONS: 210x350x110 mm

INFO

Cold zone system
Oil tap
Safety thermostat

2.064 € + V.A.T.



9725500

ELECTRIC FRYER

DIMENSIONS: 400x700x250 mm
CAPACITY: 15 lt
POWER: 15 Kw / 400 V
BASKET DIMENSIONS: 210x350x110 mm

INFO

Cold zone system
Oil tap
Safety thermostat

2.476 € + V.A.T.



9726000

ELECTRIC FRYER

DIMENSIONS: 800x700x250 mm
CAPACITY: 2x10 lt
POWER: 18 Kw / 400 V
BASKET DIMENSIONS: 210x350x110 mm

INFO

Cold zone system
Oil tap
Safety thermostat

3.261 € + V.A.T.

9724500

ADJUSTABLE FRIES HEATER

DIMENSIONS: 400x700x440 mm
CAPACITY: GN 1/1
POWER: 1 Kw / 230 V



1.609 € + V.A.T.

BAIN MARIE & NEUTRALS

made in
POLAND 



9720000

BAIN MARIE

DIMENSIONS: 400x700x250 mm
CAPACITY: GN1/1-150 mm
POWER: 0,8 Kw / 230V

INFO
Oil tap

1.094 € + V.A.T.



9721000

BAIN MARIE

DIMENSIONS: 800x700x250 mm
CAPACITY: GN1/1-150 mm
POWER: 1,6 Kw / 230V

INFO
Oil tap

1.651 € + V.A.T.



9700210

NEUTRAL

DIMENSIONS: 400x700x250 mm

INFO
Full extension drawer

578 € + V.A.T.



9700410

NEUTRAL

DIMENSIONS: 800x700x250 mm

INFO
Full extension drawer

737 € + V.A.T.

ELECTRIC GRIDDLE PLATES



9730100

ELECTRIC GRIDDLE PLATE

DIMENSIONS: 400x700x250 mm
POWER: 4 Kw/400V
SURFACE: Smooth

INFO

Grease drawer
Safety thermostat

1.443 € + V.A.T.



9730200

ELECTRIC GRIDDLE PLATE

DIMENSIONS: 400x700x250 mm
POWER: 4 Kw/400V
SURFACE: Ribbed

INFO

Grease drawer
Safety thermostat

1.713 € + V.A.T.



9731100

ELECTRIC GRIDDLE PLATE

DIMENSIONS: 800x700x250 mm
POWER: 8,1 Kw/400V
SURFACE: Smooth

INFO

Grease drawer
Safety thermostat

2.298 € + V.A.T.

9731200

ELECTRIC GRIDDLE PLATE

DIMENSIONS: 800x700x250 mm
POWER: 8,1 Kw/400V
SURFACE: Ribbed

INFO

Grease drawer
Safety thermostat

2.477 € + V.A.T.



9731300

ELECTRIC GRIDDLE PLATE

DIMENSIONS: 800x700x250 mm
POWER: 8,1 Kw/400V
SURFACE: ½ Smooth & ½ Ribbed

INFO

Grease drawer
Safety thermostat

2.477 € + V.A.T.



ELECTRIC CHROMIUM GRIDDLE PLATES

made in
POLAND 



9736100

ELECTRIC CHROME PLATED GRIDDLE PLATE

DIMENSIONS: 400x700x250 mm
POWER: 4 Kw/400V
SURFACE: Smooth chrome plated

INFO

Grease drawer
Safety thermostat

1.699 € + V.A.T.



9736200

ELECTRIC CHROME PLATED GRIDDLE PLATE

DIMENSIONS: 400x700x250 mm
POWER: 4 Kw/400V
SURFACE: Ribbed chrome plated

INFO

Grease drawer
Safety thermostat

1.892 € + V.A.T.



9737100

ELECTRIC CHROME PLATED GRIDDLE PLATE

DIMENSIONS: 800x700x250 mm
POWER: 8,1 Kw/400V
SURFACE: Smooth chrome plated

INFO

Grease drawer
Safety thermostat

2.710 € + V.A.T.



9737200

ELECTRIC CHROME PLATED GRIDDLE PLATE

DIMENSIONS: 800x700x250 mm
POWER: 8,1 Kw/400V
SURFACE: Ribbed chrome plated

INFO

Grease drawer
Safety thermostat

2.889 € + V.A.T.



9737300

ELECTRIC CHROME PLATED GRIDDLE PLATE

DIMENSIONS: 800x700x250 mm
POWER: 8,1 Kw/400V
SURFACE: ½ Smooth & ½ Ribbed chrome plated

INFO

Grease drawer
Safety thermostat

2.889 € + V.A.T.

KITCHEN EQUIPMENT SERIES 70

GAS GRIDDLE PLATES



9730130

GAS GRIDDLE PLATE

DIMENSIONS: 400x700x250 mm

POWER: 6,5 Kw

SURFACE: Smooth

INFO

Grease drawer

Safety thermostat

1.857 € + V.A.T.



9730230

GAS GRIDDLE PLATE

DIMENSIONS: 400x700x250 mm

POWER: 6,5 Kw

SURFACE: Ribbed

INFO

Grease drawer

Safety thermostat

1.843 € + V.A.T.



9731130

GAS GRIDDLE PLATE

DIMENSIONS: 800x700x250 mm

POWER: 13 Kw

SURFACE: Smooth

INFO

Grease drawer

Safety thermostat

3.247 € + V.A.T.



9731230

GAS GRIDDLE PLATE

DIMENSIONS: 800x700x250 mm

POWER: 13 Kw

SURFACE: Ribbed

INFO

Grease drawer

Safety thermostat

3.233 € + V.A.T.

9731330

GAS GRIDDLE PLATE

DIMENSIONS: 800x700x250 mm

POWER: 13 Kw

SURFACE: ½ Smooth & ½ Ribbed

INFO

Grease drawer

Safety thermostat

3.261 € + V.A.T.



GAS CHROMIUM GRIDDLE PLATES

made in
POLAND 



9736130

GAS CHROME PLATED GRIDDLE PLATE

DIMENSIONS: 400x700x250 mm
POWER: 6,5 kW
SURFACE: Smooth chrome plated

INFO

Grease drawer
Safety thermostat

2.132 € + V.A.T.



9736230

GAS CHROME PLATED GRIDDLE PLATE

DIMENSIONS: 400x700x250 mm
POWER: 6,5 kW
SURFACE: Ribbed chrome plated

INFO

Grease drawer
Safety thermostat

2.229 € + V.A.T.



9737130

GAS CHROME PLATED GRIDDLE PLATE

DIMENSIONS: 800x700x250 mm
POWER: 13 kW
SURFACE: Smooth chrome plated

INFO

Grease drawer
Safety thermostat

3.990 € + V.A.T.



9737230

GAS CHROME PLATED GRIDDLE PLATE

DIMENSIONS: 800x700x250 mm
POWER: 13 kW
SURFACE: Ribbed chrome plated

INFO

Grease drawer
Safety thermostat

4.045 € + V.A.T.



9737330

GAS CHROME PLATED GRIDDLE PLATE

DIMENSIONS: 800x700x250 mm
POWER: 13 kW
SURFACE: ½ Smooth & ½ Ribbed chrome plated

INFO

Grease drawer
Safety thermostat

3.990 € + V.A.T.

KITCHEN EQUIPMENT SERIES 70
ELECTRIC WATER GRILLS



9732000

ELECTRIC WATER GRILL

DIMENSIONS: 400x700x250 mm
 POWER: 4.08 Kw

INFO
 Safety thermostat

2.710 € + V.A.T.



9733000

ELECTRIC WATER GRILLS

DIMENSIONS: 800x700x250 mm
 POWER: 8.16 Kw

INFO
 Safety thermostat

4.126 € + V.A.T.

ELECTRIC & GAS RANGES WITH OVEN



9715000

ELECTRIC RANGE WITH ELECTRIC OVEN

DIMENSIONS: 800x700x850 mm
 PLATES: Electric, 4x2.6 kW
 OVEN: Electric, 7 kW
 TOTAL POWER: 17.4 kW / 400 V
 PLATE DIAMETER: 220 mm

OVEN DIMENSIONS: 660x445x285 mm

INFO
 Oven suitable for GN 1/1 & 40x60 cm trays
 Oven cooking modes:
 Static
 Air flow
 Humidity injection

3.206 € + V.A.T.



9710330

GAS RANGE WITH GAS OVEN

DIMENSIONS: 800x700x850 mm
 PLATES: Gas, 2x5 kW & 2x7 kW
 OVEN: Gas, 6 kW
 TOTAL POWER: 30 kW

OVEN DIMENSIONS: 660x545x285 mm

INFO
 Oven suitable for GN 2/1
 Oven cooking modes:
 Static

3.232 € + V.A.T.



9715330

GAS RANGE WITH ELECTRIC OVEN

DIMENSIONS: 800x700x850 mm
PLATES: Gas, 2x5 kW & 2x7 kW
OVEN: Electric, 7 kW
TOTAL POWER: 30 kW

OVEN DIMENSIONS: 660x445x285 mm

INFO

Oven suitable for GN 1/1
Oven cooking modes:
Static
Air flow
Humidity injection

3.735 € + V.A.T.

FLOOR MOUNTED GAS FRYERS



9725130

GAS FRYER SINGLE

DIMENSIONS: 400x700x850 mm
CAPACITY: 17 lt
POWER: 15 kW
BASKET DIMENSIONS: 310x300x120 mm

INFO

Pilot flame
Anti leakage safety device

3.426 € + V.A.T.

9725230

GAS FRYER DOUBLE

DIMENSIONS: 400x700x850 mm
CAPACITY: 2x7 lt
POWER: 12 kW
BASKET DIMENSIONS: 130x300x120 mm

INFO

Pilot flame
Anti leakage safety device

4.815 € + V.A.T.

KITCHEN EQUIPMENT SERIES 70

FLOOR MOUNTED ELECTRIC & GAS PASTA COOKERS

9745000

ELECTRIC PASTA COOKER

DIMENSIONS: 400x700x850 mm
CAPACITY: 25 lt
POWER: 6 kW / 400 V

INFO

Water drain
Safety thermostat
Baskets not included

COMBINATIONS

Basket GN 1/3 x 2 pcs
Basket GN 1/6 x 4 pcs
Basket 1x GN 1/3 + 2 x GN 1/6

2.325 € + V.A.T.

9745130

GAS PASTA COOKER

DIMENSIONS: 400x700x850 mm
CAPACITY: 25 lt
POWER: 9.1 kW

INFO

Water drain
Safety thermostat
Baskets not included

COMBINATIONS

Basket GN 1/3 x 2 pcs
Basket GN 1/6 x 4 pcs
Basket 1x GN 1/3 + 2 x GN 1/6

BASKET CODES

9799920 GN 1/3
9799930 GN 1/6

2.944 € + V.A.T.



ELECTRIC & GAS TILTING BRATT PANS

9740000

ELECTRIC TILTING BRATT PAN

DIMENSIONS: 800x700x850 mm
CAPACITY: 58 lt
POWER: 10.8 kW / 400 V

INFO

Manual tilting

4.747 € + V.A.T.

9740030

GAS TILTING BRATT PAN

DIMENSIONS: 800x700x850 mm
CAPACITY: 58 lt
POWER: 17 kW

INFO

Manual tilting

4.843 € + V.A.T.

FLOOR MOUNTED INDUCTION COOKERS made in POLAND



9705100

INDUCTION COOKER

DIMENSIONS: 400x700x850 mm
POWER: 7 kW / 400 V
PLATES: 2 induction
PLATE DIAMETER: 250 mm

4.300 € + V.A.T.

9706100

INDUCTION COOKER

DIMENSIONS: 800x700x850 mm
POWER: 14 kW / 400 V
PLATES: 4 induction
PLATE DIAMETER: 250 mm

7.581 € + V.A.T.

FREE STANDING GAS RANGES



979533

FREE STANDING GAS RANGE

DIMENSIONS: 800x700x850 mm
POWER: 2x5 + 2x7 kW
PLATES: Gas

INFO
Pilot flame
Anti leakage safety device

2.050 € + V.A.T.



979623

FREE STANDING GAS RANGE

DIMENSIONS: 1200x700x850 mm
POWER: 1x3,5 + 2x5 + 2x7 + 1x9 kW
PLATES: Gas

INFO
Pilot flame
Anti leakage safety device

2.875 € + V.A.T.

10

STORING



Doors Cold rooms Shelves

DOORS [208]

REFRIGERATION SYSTEMS [213]

COLD ROOMS [215]

COLD ROOM SHELVES [216]

MTH

a
a.l.guidovie

DOORS

HINGED & SLIDING



TYPE	TEMPERATURE	THICKNESS	THERMAL RESISTANCE	MEAT RAIL PASSAGE
500 TN	Cooling (+0°C)	68 mm	-	-
GV5	Cooling (+0°C)	68 mm	-	•
603 LWT	Freezing (-20°C)	92 mm	Rubber door seal	-
604 LWT	Freezing (-25°C)	121 mm	Rubber door seal	-
740 LWT	Freezing (-30°C)	121 mm	Door frame	-
745 LWT	Freezing (-40°C)	121 mm	Door frame & rubber seal	•
750 LWT	Freezing (-45°C)	151 mm	Door frame & rubber seal	-

Standard characteristics

- Door insulation made of high density polyurethane 40 kg/m³
- Door lining made of laminated metal sheet 0.5 mm thick
- CSI safety latch with lock certified to EN 179:2008
- Heavy duty 3D adjustable hinges
- Insulated case
- High quality rubber door seals
- Single door/ Double door
- Inox version
- Wide variety of available RAL
- Custom dimensions
- Thermal resistance in rubber door seal or door frame (freezer version)





TYPE	TEMPERATURE	THICKNESS	THERMAL RESISTANCE	MEAT RAIL PASSAGE
360 LS/FLS	Cooling (+0°C)	68 mm	-	-
480 PT	Cooling (+0°C)	68 mm	-	-
480 TN	Cooling (-5°C)	92 mm	Rubber door seal	-
480 LT	Freezing (-20°C)	92 mm	Rubber door seal	-
480 LTB	Freezing (-25°C)	121 mm	Rubber door seal	-
480 LWT	Freezing (-30°C)	121 mm	Door frame & rubber seal	-
485 LWT	Freezing (-40°C)	121 mm	Door frame & rubber seal	-
490 LWT	Freezing (-45°C)	151 mm	Door frame & rubber seal	-

Standard characteristics

- Standard characteristics Door insulation made of high density polyurethane 40 kg/m³
- Door lining made of laminated metal sheet 0.5 mm thick
- Lever type handle or fixed depending on the version
- Thermally insulated door frame
- High quality rubber door seals
- Single door/ Double door
- Inox version
- Wide variety of available RAL
- Custom dimensions
- Thermal resistance in rubber door seal or door frame (freezer version)
- Door automatic

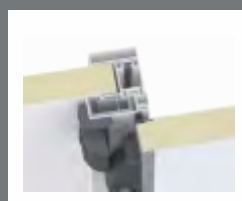

DOORS**SEMI-INSULATING**

TYPE	TEMPERATURE	THICKNESS	THERMAL RESISTANCE	MEAT RAIL PASSAGE
CA	Cooling (+0°C)	92 mm	-	-
480 PGV	Cooling (+0°C)	68 mm	-	•
450 GV	Cooling (+0°C)	92 mm	-	•
240 AM	Cooling (+0°C)	68 mm	-	-
240 S	Cooling (+0°C)	68 mm	-	-
VERTICAL TN	Cooling (-5°C)	92 mm	-	-
VERTICAL LWT	Freezing (-40°C)	121 mm	Door frame	-

Standard characteristics**VA E VIENI**





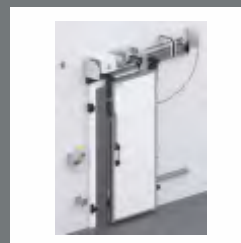

- Door insulation made of high density polyurethane 40 kg/m³
- Door lining made of laminated sheet 0.5 mm thick
- Hinges with stop at 90°
- High quality rubber door seals
- Single door/ Double door
- Stainless steel protection on the lower part of the door 30 cm high
- Oblo window 25x75 cm
- Inox or polyethylene version
- Wide variety of available RAL
- Custom dimensions

SERVICE DOOR

- Door insulation made of high density polyurethane 40 kg/m³
- Door lining made of laminated sheet 0.5 mm thick
- Aluminum door frame
- High quality rubber door seals
- Single door/ Double door
- Inox version
- Wide variety of available RAL
- Custom dimensions

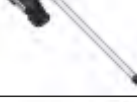

COMPONENTS

<p>11014</p> 	<p>Perimetral gasket for hinged/sliding, cooling cold room door</p>	<p>Suitable for: 500TN, GV5, 240S-AM, 480ST, 480PT, 480PGV</p>
<p>11015</p> 	<p>Perimetral gasket for hinged/sliding, cooling/freezing cold room door</p>	<p>Suitable for: 740LWT, 480TN, 480LWT, 450GV, VCD, 480CA</p>
<p>11016</p> 	<p>Perimetral gasket with heating cable passage for cooling/freezing cold room door, hinged and sliding</p>	<p>Suitable for: 603LWT, 604LWT, 480LT, VCD, SECTIONAL, 745LWT</p>
<p>11021</p> 	<p>Lower gasket for hinged/sliding, cooling cold room door</p>	<p>Suitable for: 360FLS, 480PGV, 480PT, 500TN, 540TN, 240AM, GV5, 240S</p>
<p>11022</p> 	<p>Lower gasket for hinged/sliding, freezing cold room door</p>	<p>Suitable for: 740LWT, 745LWT, 750LWT, 450GV, 480TN, 480LWT, 485LWT, 490LWT, VSD TN, VSDLWT, 603LWT, 604LWT, 480LT, 480LTB</p>
<p>18PC0005</p> 	<p>Electric heating cable 30W/m-230V for hinged/sliding, freezing cold room door</p>	<p>Suitable for: 480LWT, 485LWT, 490LWT, VSDLWT, 603LWT, 604LWT, 480LT, 480LTB, 740LWT, 745LWT, 750LWT</p>
<p>13CLE056</p> 	<p>External handle set with lock for hinged, cooling/freezing cold room door</p>	<p>Suitable for: 500TN, 540TN, GV5, 740LWT, 745LWT, 750LWT, 603LWT, 604LWT</p>
<p>13CIN002</p> 	<p>External handle CSI for hinged, cooling/freezing cold room door</p>	<p>Suitable for: 500TN, 540TN, 740LWT, 745LWT, 750LWT, 603LWT, 604LWT</p>
<p>13SEF046</p> 	<p>External lever handle for sliding cooling cold room door</p>	<p>Suitable for: 480PGV, 480PT</p>
<p>13SEF048</p> 	<p>External lever handle for sliding, cooling/freezing cold room door</p>	<p>Suitable for: 450GV, 480TN, 480LWT, 485LWT, 490LWT, 480LT, 480ATMC, 480LTB</p>
<p>14ALU201 (right) 14ALU202 (left)</p> 	<p>Aluminium door hinge</p>	<p>Suitable for: SERVICE DOOR</p>
<p>14039</p> 	<p>Sliding cold room door roller with bearing</p>	<p>Suitable for: 480PGV, 480ST, 480PT, 450GV, 480TN, 480LWT, 485LWT, 490LWT, 480LT, 480ATMC, 480LTB</p>
<p>14068 (left) 14069 (right)</p> 	<p>Sliding cold room door pulley wheel</p>	<p>Suitable for: 240S-AM</p>

DOORS / COLD ROOMS / SHELVES
HYGIENIC PROFILES

 100% MADE IN ITALY



Hygienic profiles and components, suitable for industrial refrigeration, food industry pharmaceutical warehouses. Complete range of products, ideal for compliance with sanitary regulations. The sanitary corners are used in order to avoid any kind of contamination and to facilitate the cleaning of each area.

<p>12 CEL 500</p>			<p>Sanitary corner PVC 35x35 Length 4000 mm White RAL 9010</p>
<p>12 CEL 501</p>			<p>Corner profile PVC 30x30 Length 4000 mm</p>
<p>12 CEL 502</p>			<p>Rounded sanitary corner PVC Length 4000 mm White RAL 9010</p>
<p>12 CEL 550</p>			<p>Trihedral internal corner White RAL 9010</p>
<p>12 CEL 551</p>			<p>Dihedral external corner White RAL 9010</p>
<p>12 CEL 552</p>			<p>Sanitary corner end cap White RAL 9010</p>

REFRIGERANTS

MONOBLOCK UNITS

since 1942
MTH

 100% MADE IN ITALY



CODE	DESCRIPTION	APPLICATION	VOLUME (m ³)	HP
19131040	MONOBLOCCO UMZHU/04S1-R290	0°C / +43°C	4,0	0,5
19131050	MONOBLOCCO UMZHU/05S1-R290		5,0	0,8
19131090	MONOBLOCCO UMZHU/09S2-R290		9,0	2x1/2
19131120	MONOBLOCCO UMZHU/12S2-R290		12,0	2x3/4
19131180	MONOBLOCCO UMZHU/18A3-R290		18,0	2x1
19135030	MONOBLOCCO UMZU/03S1-R290	-25°C/+43°C	3,0	1,0
19135040	MONOBLOCCO UMZU/04A1-R290		4,0	1,2
19135080	MONOBLOCCO UMZU/08S2-R290		8,5	2x1
19135130	MONOBLOCCO UMZU/13A3-R290		13,0	2x1,2

CODE	DESCRIPTION	APPLICATION	VOLUME (m ³)	HP
19101040	UMZHG/04A1	0°C / +43°C	5,2	0,5
19101050	UMZHG/05A1		6,9	0,6
19101070	UMZHG/07A1		9,6	0,8
19101080	UMZHG/08A1		10,6	1,0
19101123	UMZHG/12A2		16,11	1,2
19101163	UMZHG/16A2		20,7	1,5
19102191	T UMZHG/19U3		23,2	1,8
19102231	T UMZHG/23U3		28,8	2,0
19105030	UMZG/03A1	-25°C/+43°C	2,6	1,2
19105050	UMZG/05A1		4,2	1,5
19105081	UMZG/08U2		7,0	2,0
19105111	UMZG/11U2		10,6	2,7
19106151	TUMZG/15U3		15,0	3,0
19106171	TUMZG/17U3		17,0	4,0

CODE	DESCRIPTION	DIMENSIONS	SIZE	COLOUR
KT/00191	KIT PANELTHROUGHWALLSP.mm.60TN	450x500	1	White
KT/00192	KIT PANELTHROUGHWALLSP.mm.60TN	750x500	2	White
KT/00193	KIT PANELTHROUGHWALLSP.mm.60TN	750x600	3	White
KT/00198	KIT PANELTHROUGHWALLSP.mm.80	450x500	1	White
KT/00199	KIT PANELTHROUGHWALLSP.mm.80	750x500	2	White
KT/00200	KIT PANELTHROUGHWALLSP.mm.80	750x600	3	White
KT/00194	KIT PANELTHROUGHWALLSP.mm.100	450x500	1	White
KT/00195	KIT PANELTHROUGHWALLSP.mm.100	750x500	2	White
KT/00196	KIT PANELTHROUGHWALLSP.mm.100	750x600	3	White

DOORS / COLD ROOMS / SHELVES
REFRIGERANTS
MOTORS / VENTILATORS

 100% MADE IN ITALY



COLD ROOMS

MODULAR

Modular cold rooms
cooling & freezing

Panel: 8cm / 10cm / 12cm / 14cm

Dimensional development every 20cm!

since 1942
MTH

 100% MADE IN ITALY



Multi-door cabinets
cooling & freezing

DOORS / COLD ROOMS / SHELVES

SHELVES

COLD ROOM SHELVES

LIGHT VERSION // M



dimensions

SHELF WIDTH

30 / 40 / 45 / 60 cm

SHELF LENGTH

3.2 cm

UPRIGHT HEIGHT

155 / 165 / 185 / 205 cm

ADJUSTABLE SHELF HEIGHT
every 15 cm

compositions





i technical characteristics

- 

**AL+PP
+ AISI 304** Certified anodised aluminium alloy frame and polypropylene staves
- 

Open-faced corner compositions
- 

Suitable for direct food contact
- 

Stable and resistant
- 

Adjustable feet
- 

HACCP Haccp Standards
- 

Easy and quick assembly
- 

Certified weight strength (Eurocode 9) with load capacity 130 – 240 kg per shelf



SHELF WITH POLYPROPYLENE PERFORATED STAVES

Single perforated stave ideal for 30, 40 and 45 cm shelves

Double perforated stave ideal for 60 cm shelves



SHELF WITH STAINLESS STEEL AISI 304 COVER M-1



HANGING BARS FOR SALAMI

Available with 2, 3 or 4 bars

134 M



135 M 136 M

DOORS / COLD ROOMS / SHELVES

SHELVES

COLD ROOM SHELVES

STRONG VERSION // P



dimensions

SHELF WIDTH

30 / 40 / 45 / 60 / 70 / 75 /
80 / 85 / 90 cm

SHELF LENGTH

9 cm

UPRIGHT HEIGHT

150 / 180 / 200 cm

ADJUSTABLE SHELF HEIGHT
every 15 cm

compositions



i technical characteristics



Certified anodised aluminium alloy frame and polypropylene staves



Open-faced corner compositions



Suitable for direct food contact



Stable and resistant



Adjustable feet



Haccp Standards



Easy and quick assembly



Certified weight strength (Eurocode 9) with load capacity 175 – 725 kg per shelf

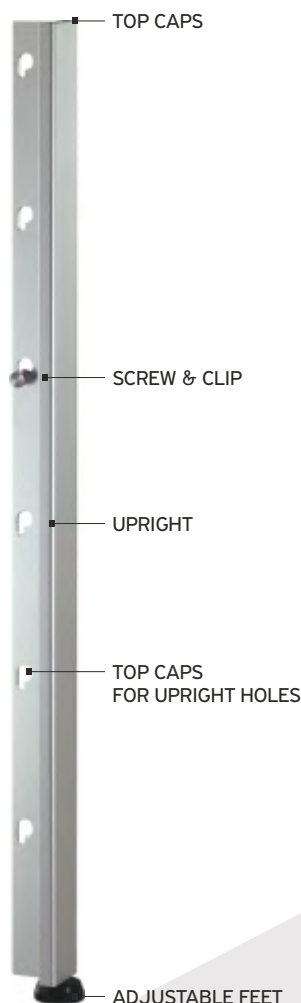

SHELF WITH POLYPROPYLENE STAVES

Single perforated stave ideal for 30, 40 and 45 cm shelves

Double perforated stave ideal for 60, 70, 75, 80, 85 and 90 cm



SHELF WITH POLYPROPYLENE PERFORATED STAVES

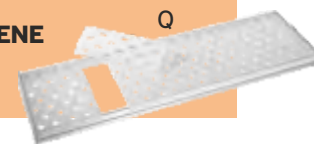

SHELF WITH STAINLESS STEEL AISI 304 COVER

P-1 / Q-1

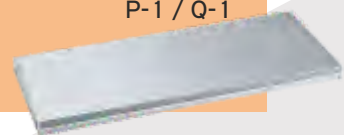

HANGING BARS FOR SALAMI

Available with 2, 3 or 4 bars

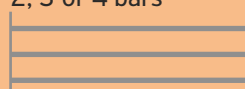
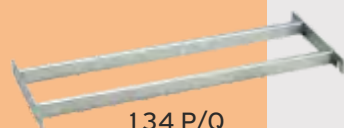

135 P/Q

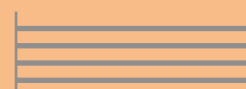

136 P/Q

BANK ACCOUNTS

ALPHA BANK

151002002014873

IBAN: GR 8601401510151002002014873

PIRAEUS BANK

6420140036472

IBAN: GR 7401714200006420140036472

EUROBANK

0026.0220.91.0200767515

IBAN: GR 2202602200000910200767515

PANCRETABANK

30000328954-4

IBAN: GR 9808700560000300003289544

20

P R I C E L I S T

26



Λεωφόρος Αθηνών 271, 124 61 Χαϊδάρη, Αθήνα
271 Athens Avenue, 124 61 Chaidari, Greece

T +30 210.58.10.600

F +30 210.58.10.610

E info@ventus.com.gr

S www.ventus.com.gr