

FOOD SERVICE EQUIPMENT

VENTUS

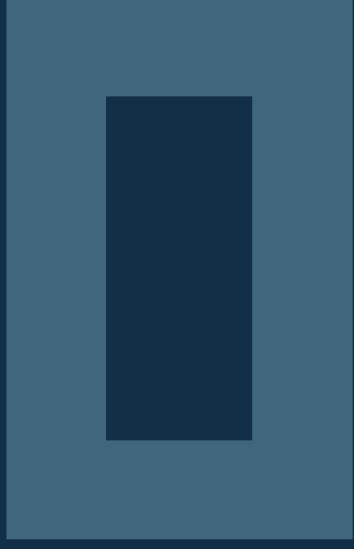

PRICELIST

After 28 years of success in the market of food service equipment, having acquired a remarkable network of branded customers and suppliers, as well as valuable associates, «VENTUS FOOD SERVICE EQUIPMENT & SOLUTIONS S.A.» was founded.

The main activities of «VENTUS FOOD SERVICE EQUIPMENT & SOLUTIONS S.A.» are:

- trading of professional equipment for hotels, restaurants, cafes and bars
- providing installation, maintenance and repair services for our products
- providing advisement, design and implementation services for our customers

Long-standing personal partnerships with branded factories and worldwide firms offers «VENTUS FOOD SERVICE EQUIPMENT & SOLUTIONS S.A.» the ability to provide high quality products and solutions at highly competitive prices.

The wide range of our products and our experienced partners are at your disposal.

Panagiotis Chaitaidis

Contents

COOKING EQUIPMENT



FRYERS [08] PASTA COOKERS [10] FOOD HEATING LAMPS [11] GRIDDLE PLATES [12] CONTACT GRILLS [14] TOASTERS [16] SALAMANDERS [16] INDUCTION COOKERS [17] PIZZA OVENS [17] MICROWAVE OVENS [17] CREPE MAKERS [18] WAFFLE MAKERS [19] POP CORN MAKER [19] SOUS VIDE CIRCULATORS [20] HEATED DISPENSERS [20] SOUP COOKERS [20] BAIN MARIE [21] CHAFING DISH [21] MEAT GRINDERS [22] POTATO SLICERS [23] BURGER PRESSERS [23] HAM SLICING MACHINES [23] SQUEEZERS [24] BLENDERS [25] PASTRY MIXERS [25] KITCHEN UTENSILS [26] THERMOMETERS [27] TROLLEYS [28]

DISPLAYS



DISPLAY REFRIGERATORS [32] WINE [43] COUNTERTOP [44] SUSHI [54] NEUTRAL [55] REFRIGERATED DISPLAYS [56] ICE CREAM [60]

FREEZERS

CHEST FREEZERS [64] FLAT SLIDING GLASS LID FREEZERS [66] CURVED SLIDING GLASS LID FREEZERS [69] VERTICAL FREEZERS [70] BEER CHEST FREEZER [71]

OVENS



CONVECTION ELECTRIC OVENS [74] COMBI STEAM OVENS GALILEI SERIES [79] COMBI STEAM OVENS VESPUCCI SERIES [86] COMBI STEAM OVENS COLOMBO EXPLORA SERIES [90] CONDENSATION HOODS [94] PROVERS [95] PIZZA OVENS [96] TRAYS & GRILLS [98] OVEN CLEANERS [102]

DISHWASHERS



ECO SERIES [106] UNDERCOUNTER [108] HOOD-TYPE [117] UTENSIL [120] TUNNELS [123] ACCESSORIES [125]

ICEMAKERS



FULL ICE CUBE [130] HOLLOW ICE CUBE [137] GRANULAR ICE [139] FLAT ICE FLAKE [141]
STORAGE BINS [142]



HOLLOW ICE CUBE [144] DICE ICE CUBE [145] STORAGE BINS [147]

INOX

GREASE COLLECTORS [150] HAND SINKS HACCP [151] WASTE CONTAINERS [151] RACKS [152]
GLASSWARE CABINETS [152] WORKING TABLES [154] TABLES WITH SINK [156] REFRIGERATED
COUNTERS [159] CABINETS [161] GASTRONORME CONTAINERS [162]

BLAST CHILLERS - SHOCK FREEZERS

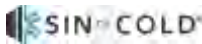

BLAST CHILLERS - SHOCK FREEZERS [166]

KITCHEN EQUIPMENT



COUNTERTOP ELECTRIC & GAS STOVES [170] COUNTERTOP ELECTRIC FRYERS [172] BAIN MARIE &
NEUTRALS [173] ELECTRIC & GAS GRIDDLE PLATES [174] ELECTRIC WATER GRILLS [178] ELECTRIC
& GAS RANGES WITH OVEN [178] FLOOR MOUNTED GAS FRYERS [179] FLOOR MOUNTED ELECTRIC &
GAS PASTA COOKERS [180] ELECTRIC & GAS TILTING BRATT PANS [180] FLOOR MOUNTED INDUCTION
COOKERS [181] GAS FREE STANDING RANGES [181]

DOORS / COLD ROOM / SHELVES



DOORS [184] REFRIGERATION SYSTEMS [188] COLD ROOMS [189] COLD ROOM SHELVES [190]

Suppliers



Index

- BAINMARIE [21, 173]
- BLAST CHILLERS-SHOCK FREEZERS [166]
- BLENDERS [25]
- BURGER PRESSERS [23]

- CABINETS [160]
- CHAFING DISH [21]
- CHEST FREEZERS [64, 71]
- COLD ROOM DOORS [184]
- COLD ROOM SHELVES [190]
- COLD ROOMS [189]
- COMBI STEAM OVENS [79]
- CONDENSATION HOODS [94]
- CONTACT GRILLS [14]
- CONVECTION OVENS [74]
- COUNTERTOP DISPLAYS [44]
- CREPE MAKERS [18]

- DISHWASHERS [106]
- DISHWASHERS ACCESSORIES [125]
- DISHWASHERS BASKETS [125]
- DISPLAY REFRIGERATORS [32]

- FOOD HEATING LAMPS [11]
- FREEZERS HORIZONTAL [66]
- FREEZERS VERTICAL [70]
- FRYERS [8, 172, 179]

- GASTRONORME CONTAINERS [162]
- GLASSWARE CABINETS [152, 153]
- GREASE COLLECTORS [150]
- GRIDDLE PLATES [12, 174]

- HAM SLICING MACHINES [23]
- HAND SINKS HACCP [151]
- HEATED DISPENSERS [20]

- ICE CREAM DISPLAYS [60]
- ICE DICE CUBE [145]
- ICE FLAT FLAKE [141]
- ICE FULL CUBE [130]
- ICE GRANULAR [139]
- ICE HOLLOW CUBE [137, 144]
- ICEMAKERS STORAGE BINS [142, 147]
- ICEMAKERS STORAGE BINS [142, 147]
- INDUCTION COOKERS [17, 181]

- KITCHEN UTENSILS [26]

- MEAT GRINDERS [22]
- MICROWAVE OVENS [17]

- NEUTRAL DISPLAYS [55]
- NEUTRALS [173]

- OVEN CLEANERS [102]
- OVEN GRILLS [100]
- OVEN TRAYS [98]

- PASTA COOKERS [10, 180]
- PASTRY MIXERS [25]
- PIZZA OVENS [17, 96]
- POPCORN MAKER [19]
- POTATO SLICERS [23]
- PROVERS [95]

- RACKS [152]
- RANGES WITH OVEN [178]
- RANGES FREE STANDING [178]
- REFRIGERATED COUNTERS [159]
- REFRIGERATED DISPLAYS [56]
- REFRIGERATION SYSTEMS [188]

- SALAMANDERS [16]
- SOUP COOKERS [20]
- SOUS VIDE [20]
- SQUEEZERS [24]
- STOVES [170]
- SUSHI DISPLAYS [54]

- TABLES WITH SINK [156]
- TABLES WORKING [154]
- THERMOMETERS [27]
- TILTING BRATT PANS [180]
- TOASTERS [16]
- TROLLEYS [28]
- TUNNELS [123]

- WAFFLE MAKERS [19]
- WASTE CONTAINERS [151]
- WATER GRILLS [178]
- WINE DISPLAYS [43]
- WORKING TABLES [154]



C O O K I N G

COOKING EQUIPMENT

FRYERS	[08]
PASTA COOKERS	[10]
FOOD HEATING LAMPS	[11]
GRIDDLE PLATES	[12]
CONTACT GRILLS	[14]
TOASTERS	[16]
SALAMANDERS	[16]
INDUCTION COOKERS	[17]
PIZZA OVENS	[17]
MICROWAVE OVENS	[17]
CREPE MAKERS	[18]
WAFFLE MAKERS	[19]
POP CORN MAKER	[19]
SOUS VIDE CIRCULATORS	[20]
HEATED DISPENSERS	[20]
SOUP COOKERS	[20]
BAIN MARIE	[21]
CHAFING DISH	[21]
MEAT GRINDERS	[22]
POTATO SLICERS	[23]
BURGER PRESSERS	[23]
HAM SLICING MACHINES	[23]
SQUEEZERS	[24]
BLENDERS	[25]
PASTRY MIXERS	[25]
KITCHEN UTENSILS	[26]
THERMOMETERS	[27]
TROLLEYS	[28]

Fryers

FRY E4

ELECTRIC FRYER SINGLE

DIMENSIONS: 270x430x310 mm
BASKET DIMENSIONS: 18x21x11 cm
POWER: 2500 Watt - 230 V
TEMPERATURE: 50 - 190°C
CAPACITY: 4 lt

INFO

Stainless steel casing
Safety thermostat
Basket with moulded handle
Removable oil container

■ **105 €** + V.A.T.



FRY S4

ELECTRIC FRYER SINGLE

DIMENSIONS: 190x440x330 mm
BASKET DIMENSIONS: 10x24x12 cm
POWER: 2500 Watt - 230 V
TEMPERATURE: 50 - 190°C
CAPACITY: 4 lt

INFO

Stainless steel casing
On/Off switch
Safety thermostat
Basket with moulded handle
Removable oil container

■ **149 €** + V.A.T.



FRY S44

ELECTRIC FRYER DOUBLE

DIMENSIONS: 390x440x330 mm
BASKET DIMENSIONS: 10x24x12 cm
POWER: 2500+2500 Watt - 230 V
TEMPERATURE: 50 - 190°C
CAPACITY: 4+4 lt

INFO

Stainless steel casing
On/Off switch
Safety thermostat
Basket with moulded handle
Removable oil container

■ **265 €** + V.A.T.





FRY S8

ELECTRIC FRYER SINGLE

DIMENSIONS: 270x420x350 mm
BASKET DIMENSIONS: 18x24x14 cm
POWER: 3000 Watt - 230 V
TEMPERATURE: 50 - 190°C
CAPACITY: 8 lt

INFO

Stainless steel casing
Safety thermostat
Basket with moulded handle
Removable oil container

■ **159 €** + V.A.T.



FRY S88

ELECTRIC FRYER DOUBLE

DIMENSIONS: 530x420x350 mm
BASKET DIMENSIONS: 18x24x14 cm
POWER: 3000+3000 Watt - 230 V
TEMPERATURE: 50 - 190°C
CAPACITY: 8+8 lt

INFO

Stainless steel casing
Safety thermostat
Basket with moulded handle
Removable oil container

■ **290 €** + V.A.T.

NEW



FRY ST10

ELECTRIC FRYER SINGLE 3 PHASE (HEAVY DUTY)

DIMENSIONS: 340x540x410 mm
BASKET DIMENSIONS: 24x28x14 cm
POWER: 6000 Watt - 380 V
TEMPERATURE: 50 - 190°C
CAPACITY: 10 lt

INFO

Stainless steel casing
On/Off switch
Safety thermostat
Basket with moulded handle
Micro-switch activation of the unit head
Oil tap
Bucket rounded inside
Timer

■ **397 €** + V.A.T.

Fryers

FRY DT10

ELECTRIC FRYER DOUBLE 3 PHASE (HEAVY DUTY)

DIMENSIONS: 690x540x410 mm
BASKET DIMENSIONS: 24x28x14 cm
POWER: 6000+6000 Watt - 380 V
TEMPERATURE: 50 - 190°C
CAPACITY: 10+ 10 lt

INFO

Stainless steel casing
On/Off switch
Safety thermostat
Basket with moulded handle
Micro-switch activation of the unit head
Oil tap
Bucket rounded inside
Timer

■ 798 € + V.A.T.

NEW



Pasta Cookers

VEP 4

ELECTRIC PASTA COOKER 4 BASKETS

DIMENSIONS: 410x570x280 mm
POWER: 4000 Watt - 220 V

INFO

Stainless steel casing
Stainless steel resistors
Round wire basket
Oil tap

■ 235 € + V.A.T.

NEW



PCG 40G

GAS PASTA COOKER

DIMENSIONS: 400x700x900(+ 140) mm
BASIN DIMENSIONS: 310x397x230 mm
POWER: 12 Kw
CAPACITY: 25 lt

INFO

Stainless steel casing Aisi304
2 baskets (296 x 172 x 213mm)

■ 1.350 € + V.A.T.

NEW



Food Heating Lamps

NEW



FW 500

FOOD HEATING LAMP

DIMENSIONS: 420x440x580 mm
POWER: 500 Watt - 230 V

INFO

Aluminium casing
2 lamps
Suitable for GN 1/1 containers (not included)

189 € + V.A.T.



522360

FOOD HEATING LAMP

DIMENSIONS: 600x335x580 mm
POWER: 500 Watt - 230 V

INFO

Stainless steel casing
2 lamps
Suitable for GN 1/1 containers

270 € + V.A.T.

NEW



VA 33BR/33BL/33SL

FOOD HEATING LAMP

POWER: 250 Watt - 230 V
DIAMETER: Ø 270 mm
COLOR: Copper | Black | Silver

INFO

Adjustable height 600-1800 mm

90 € + V.A.T.

NEW



VA 32BR/32BL/32SL

FOOD HEATING LAMP

POWER: 250 Watt - 230 V
DIAMETER: Ø 175 mm
COLOR: Copper | Black | Silver

INFO

Adjustable height 600-1800 mm

86 € + V.A.T.

Griddle Plates

VEG 350

ELECTRIC GRIDDLE PLATE

DIMENSIONS: 350x520x275 mm
POWER: 2200 Watt - 230 V
TEMPERATURE: 50 - 300°C

INFO

Stainless steel casing
Grease drawer
1 heating zone

■ **198€** + V.A.T.

NEW



VEG 818

ELECTRIC GRIDDLE PLATE

DIMENSIONS: 550x420x160 mm
POWER: 3000 Watt - 230 V
TEMPERATURE: 50 - 300°C

INFO

Stainless steel casing
Grease drawer
1 heating zone

■ **235 €** + V.A.T.

NEW



VEG 821

ELECTRIC GRIDDLE PLATE

DIMENSIONS: 730x470x240 mm
POWER: 4400 Watt - 230 V
TEMPERATURE: 50 - 300°C

INFO

Stainless steel casing
Grease drawer
2 heating zones

■ **290 €** + V.A.T.

NEW



VEG 822

ELECTRIC GRIDDLE PLATE

DIMENSIONS: 730x470x240 mm
POWER: 4400 Watt - 230 V
TEMPERATURE: 50 - 300°C

INFO

Stainless steel casing
Grease drawer
2 heating zones

■ **310 €** + V.A.T.





VEG 700

ELECTRIC GRIDDLE PLATE

DIMENSIONS: 700x520x320 mm
POWER: 4500 Watt - 230 V
TEMPERATURE: 50 - 300°C

INFO

Stainless steel casing
Grease drawer
2 heating zones

■ **540 €** + V.A.T.



VEG 853

ELECTRIC GRIDDLE PLATE

DIMENSIONS: 760x650x560 mm
POWER: 6000 Watt - 230 V
TEMPERATURE: 50 - 300°C

INFO

Stainless steel casing
Grease drawer
2 heating zones

■ **1.250 €** + V.A.T.

NEW



VEG 500 C

CHROME PLATED GRIDDLE PLATE

DIMENSIONS: 500x520x320 mm
POWER: 3000 Watt - 230 V
TEMPERATURE: 50 - 300°C

INFO

Stainless steel casing
Grease drawer
1 heating zone
Chrome plated surface 10 mm

■ **470 €** + V.A.T.

NEW



VEG 920 C

CHROME PLATED GRIDDLE PLATE

DIMENSIONS: 760x600x350 mm
POWER: 6000 Watt - 230 V
TEMPERATURE: 50 - 300°C

INFO

Stainless steel casing
Grease drawer
1 heating zone
Chrome plated surface 10 mm

■ **690 €** + V.A.T.

Contact Grills



601510

CONTACT GRILL SINGLE [PGR 11]

DIMENSIONS: 260x360x200 mm
PLATE DIMENSIONS: 240x265 mm
POWER: 1300 Watt - 230 V
TEMPERATURE: 50 - 300°C
PLATE: Top & bottom ribbed cast iron plates

INFO

Stainless steel casing
Grease drawer
Spring

■ **195 €** + V.A.T.



604510

CONTACT GRILL SINGLE [PGR 12]

DIMENSIONS: 360x310x200 mm
PLATE DIMENSIONS: 345x210 mm
POWER: 1800 Watt - 230 V
TEMPERATURE: 50 - 300°C
PLATE: Top & bottom ribbed cast iron plates

INFO

Stainless steel casing
Grease drawer
Spring

■ **235 €** + V.A.T.



602510

CONTACT GRILL MEDIUM [PGR 13]

DIMENSIONS: 400x360x200 mm
PLATE DIMENSIONS: 385x250 mm
POWER: 1800 Watt - 230 V
TEMPERATURE: 50 - 300°C
PLATE: Top & bottom ribbed cast iron plates

INFO

Stainless steel casing
Grease drawer
Spring

■ **285 €** + V.A.T.



602510 Black

CONTACT GRILL MEDIUM [PGR 13 Black]

■ **310 €** + V.A.T.

NEW



NEW

FOOD SERVICE SOLUTIONS
GALORE



VEML 2

CONTACT GRILL MEDIUM

DIMENSIONS: 430x370x210 mm
PLATE DIMENSIONS: 345x230 mm
POWER: 2200 Watt - 230 V
TEMPERATURE: 50 - 300°C
PLATE: Top & bottom smooth cast iron plates

INFO

Stainless steel casing
Grease drawer
Spring

■ **280 €** + V.A.T.



SLS
EQUIPMENT
FOOD SERVICE SOLUTIONS

603510

CONTACT GRILL MEDIUM XL [PGR 14]

DIMENSIONS: 500x390x200 mm
PLATE DIMENSIONS: 490x300 mm
POWER: 2500 Watt - 230 V
TEMPERATURE: 50 - 300°C
PLATE: Top & bottom ribbed cast iron plates

INFO

Stainless steel casing
Grease drawer
Spring

■ **355 €** + V.A.T.



SLS
EQUIPMENT
FOOD SERVICE SOLUTIONS

633051

CONTACT GRILL DOUBLE [PGR 15]

DIMENSIONS: 500x390x200 mm
PLATE DIMENSIONS: 490x300 mm
POWER: 3000 Watt - 230 V
TEMPERATURE: 50 - 300°C
PLATE: Top & bottom ribbed cast iron plates

INFO

Stainless steel casing
Grease drawer
Spring

■ **399 €** + V.A.T.

Toasters

VE 4AM

4-SLICE TOASTER

DIMENSIONS: 370x210x225 mm
POWER: 2300 Watt - 230 V
CAPACITY: 4 slots

INFO

Stainless steel casing
Timer

■ **180 €** + V.A.T.

NEW



VE 6AM

6-SLICE TOASTER

DIMENSIONS: 460x210x225 mm
POWER: 3240 Watt - 230 V
CAPACITY: 6 slots

INFO

Stainless steel casing
Timer

■ **195 €** + V.A.T.

NEW



Salamanders

VE 450

SALAMANDER

DIMENSIONS: 450x520x520 mm
GRID DIMENSIONS: 440x320 mm
POWER: 2800 Watt - 230 V

INFO

Stainless steel casing
Top thermal resistor
Adjustable height top part
Chrome grid

■ **810 €** + V.A.T.

NEW



VE 600

SALAMANDER

DIMENSIONS: 600x520x520 mm
GRID DIMENSIONS: 590x320 mm
POWER: 4000 Watt - 230 V

INFO

Stainless steel casing
Top thermal resistor
Adjustable height top part
Chrome grid

■ **980 €** + V.A.T.

NEW



Induction Cooker



770350

DIGITAL INDUCTION COOKER

DIMENSIONS: 325x425x100 mm
POWER: 3500 Watt - 230 V
TEMPERATURE: 50 - 240°C

INFO

Suitable for induction utensils Ø120-320mm
Stainless steel casing
Control panel touch

■ **370 €** + V.A.T.

Ovens



EP 30

PIZZA OVEN

DIMENSIONS: 490x380x190 mm
POWER: 1130 Watt - 230 V
GRILL DIMENSIONS: 36x34 cm

INFO

Stainless steel casing
Timer

■ **250 €** + V.A.T.

775002

ANALOG MICROWAVE OVEN



DIMENSIONS Ext.: 483x420x281 mm
DIMENSIONS Int.: 340x345x230 mm
CAPACITY: 25 lt
POWER: 900 Watt - 230 V
TIMER: 30 min

INFO

Body and chamber made of stainless steel
Defrost function
Rotating base Ø270mm

■ **310 €** + V.A.T.

775010

DIGITAL MICROWAVE OVEN



DIMENSIONS Ext.: 520x442x312 mm
DIMENSIONS Int.: 335x364x212 mm
CAPACITY: 25 lt
POWER: 1000 Watt - 230 V
TIMER: 100 min
PROGRAMMES: 20 with 3 steps

INFO

Body and chamber made of stainless steel
Defrost function
Suitable for GN 1/2 containers (height 65-150 mm)

■ **690 €** + V.A.T.

Crepe Makers

VCRS 1

1-PLATE ELECTRIC CREPE MAKER

DIMENSIONS: 450x500x230 mm
PLATE DIAMETER: Ø40 cm
POWER: 3000 Watt - 230 V
TEMPERATURE: 50 - 300°C

INFO

Stainless steel casing
Drawer
Non-stick plate

■ **380 €** + V.A.T.

NEW

FOOD SERVICE SOLUTIONS
GALORE



VCRS 2

2-PLATES ELECTRIC CREPE MAKER

DIMENSIONS: 900x500x230 mm
PLATE DIAMETER: Ø40 cm
POWER: 3000+3000 Watt - 230 V
TEMPERATURE: 50 - 300°C

INFO

Stainless steel casing
Drawer
Non-stick plate

■ **750 €** + V.A.T.

NEW

FOOD SERVICE SOLUTIONS
GALORE



061601

1-PLATE ELECTRIC CREPE MAKER CRM 01

DIMENSIONS: 410x480x180 mm
PLATE DIAMETER: Ø40 cm
POWER: 2200 Watt - 230 V
TEMPERATURE: 60 - 300°C

INFO

Stainless steel casing
Non-stick plate

■ **350 €** + V.A.T.

SLS
EQUIPMENT
SMALL LINE SOLUTIONS



061602

2-PLATES ELECTRIC CREPE MAKER CRM 02

DIMENSIONS: 820x480x180 mm
PLATE DIAMETER: Ø40 cm
POWER: 2200+2200 Watt - 230 V
TEMPERATURE: 60 - 300°C

INFO

Stainless steel casing
Non-stick plate

■ **590 €** + V.A.T.

SLS
EQUIPMENT
SMALL LINE SOLUTIONS



Waffle Makers



VE 2205

ELECTRIC WAFFLE MAKER SINGLE

DIMENSIONS: 265x440x270 mm
WAFFLE DIMENSIONS: Ø18 cm
POWER: 1300 Watt - 230 V
TEMPERATURE: 50 - 300°C

INFO

Stainless steel casing
Non-stick plates
Rotating

■ **270 €** + V.A.T.

NEW



VE 2205D

ELECTRIC WAFFLE MAKER SINGLE DIGITAL

DIMENSIONS: 255x480x295 mm
WAFFLE DIMENSIONS: Ø18 cm
POWER: 1200 Watt - 230 V
TEMPERATURE: 50 - 300°C

INFO

Stainless steel casing
Non-stick plates
Rotating

■ **430 €** + V.A.T.

Pop Corn



VE 6BC

POP CORN MAKER

DIMENSIONS: 560x420x760 mm
POWER: 1440 Watt - 230 V

INFO

Production 80z

■ **290 €** + V.A.T.

Sous Vide

SV 150A

SOUS VIDE CIRCULATOR

DIMENSIONS: 140x110x323 mm

POWER: 1500 Watt - 230 V

INFO

Digital display

Suitable for water container up to 30 lt

■ **420 €** + V.A.T.



Heated Dispencers

CW 04

HEATED DISPENSER

DIMENSIONS: 230x420x390 mm

POWER: 550 Watt - 230 V

TEMPERATURE: up to 99°C

INFO

Heated nozzle

Stainless steel construction

Suitable for Cheddar

■ **410 €** + V.A.T.



Soup Cookers

VEK 10

SOUP COOKER

DIMENSIONS: Ø 350x360 mm

POWER: 400 Watt - 230 V

CAPACITY: 10 lt

■ **129 €** + V.A.T.



Meat Grinders

VC 12

MEAT GRINDER

DIMENSIONS: 400x190x410 mm

POWER: 550 Watt

OUTPUT: 120 Kg/h

INFO

Stainless steel construction

Including:

knife

snail

3 plates 4,6 & 8 mm

■ **498 €** + V.A.T.

NEW



VC 22

MEAT GRINDER

DIMENSIONS: 410x240x450 mm

POWER: 750 Watt

OUTPUT: 220 Kg/h

INFO

Stainless steel construction

Including:

knife

snail

3 plates 4,6 & 8 mm

■ **697 €** + V.A.T.

NEW



VC 32

MEAT GRINDER

DIMENSIONS: 530x270x500 mm

POWER: 1500 Watt

OUTPUT: 320 Kg/h

INFO

Stainless steel construction

Including:

knife

snail

3 plates 4,6 & 8 mm

■ **1390 €** + V.A.T.

NEW



Bain Marie

NEW



BM 150

COUNTERTOP BAIN MARIE

DIMENSIONS: 340x570x242 mm
CAPACITY: GN 1/1-150 mm
POWER: 1200 Watt - 230 V
TEMPERATURE: up to 85°C

INFO

Stainless steel casing
GN container not included

■ 175 € + V.A.T.

NEW



BM 200

COUNTERTOP BAIN MARIE WITH TAP

DIMENSIONS: 340x590x280 mm
CAPACITY: GN 1/1-200 mm
POWER: 1200 Watt - 230 V
TEMPERATURE: up to 85°C

INFO

Stainless steel casing
Oil tap
GN container not included

■ 210 € + V.A.T.

Chafing Dish

NEW



VE 351N

CHAFING DISH

DIMENSIONS: 750x640x390 mm
CAPACITY: GN 1/1-65 mm

INFO

Including:
2 fuel holders 1 GN 1/1-65mm
1 GN 1/1-65mm

■ 130 € + V.A.T.

NEW



VE 350N

CHAFING DISH ROLL TOP

DIMENSIONS: 610x470x280 mm
CAPACITY: GN 1/1-65 mm

INFO

Roll top 180°
Including:
2 fuel holders 1 GN 1/1-65mm
1 GN 1/1-65mm

■ 270 € + V.A.T.

Potato Slicers



VEG 03

MANUAL POTATO SLICER

DIMENSIONS: 370x190x260

INFO

Including 3 knives: 6 mm, 9 mm, 13 mm

■ **149 €** + V.A.T.

Burger Pressers

NEW



VH 130

MANUAL BURGER PRESSER

DIMENSIONS: 275x230x300 mm

DIAMETER: Ø 130 mm

INFO

Anodised aluminium body
Stainless steel internal
Non-slip feet

■ **210 €** + V.A.T.

Ham Slicing Machines



VE 250ES

HAM SLICING MACHINE WITH BELT Ø250 mm

DIMENSIONS: 490x390x380 mm

POWER: 320watt

CUTTING ADJUSTMENT: up to 10 mm

■ **740 €** + V.A.T.

VE 300ES

HAM SLICING MACHINE WITH BELT Ø300 mm

DIMENSIONS: 530x460x460 mm

POWER: 420watt

CUTTING ADJUSTMENT: up to 15 mm

■ **1090 €** + V.A.T.

Squeezers

VE 205

ELECTRIC SQUEEZER

DIMENSIONS: 300x190x340 mm

POWER: 180 Watt - 230 V

■ **240 €** + V.A.T.



VE 180

ELECTRIC SQUEEZER

DIMENSIONS: 200x300x350 mm

POWER: 250 Watt - 230 V

■ **189 €** + V.A.T.

NEW



480021

ELECTRIC SQUEEZER

DIMENSIONS: 212x287x396 mm

POWER: 230 Watt - 230 V

INFO

Presser lever

Construction of stainless steel and aluminium

■ **410 €** + V.A.T.



stainless steel
internal parts



Blenders



010

ANALOG BLENDER

DIMENSIONS: 175x215x480 mm
JAR CAPACITY: 2 lt
POWER: 1500 Watt
ROTATION SPEED: 26000-28000 rpm
SPEED SETTINGS: Adjustable + Pulse function

INFO

Stainless steel blades
Polycarbonate blender jar
Non-slip base

■ 180 € + V.A.T.

NEW



DBL 100

DIGITAL BLENDER

DIMENSIONS: 210x210x540 mm
JAR CAPACITY: 2 lt
POWER: 1800 Watt
ROTATION SPEED: 20000-24000 rpm
SPEED SETTINGS: Adjustable + Pulse function

INFO

Stainless steel blades
Polycarbonate blender jar
Non-slip base
Lcd touch screen
Motor overheating protection
8 programmes

■ 260 € + V.A.T.

Pastry Mixers

NEW



B7W 500

PASTRY MIXER

DIMENSIONS: 380x235x405 mm
CAPACITY: 7 lt
POWER: 500 Watt
SPEED: Adjustable 0-1000 prn

INFO

Stainless steel bowl
White color
Max flour quantity: 750 gr
Mixing cream: 1500 gr
Included: balloon whisk, dough hook & shovel

■ 695 € + V.A.T.

Pastry Mixers

B7S 500

PASTRY MIXER

DIMENSIONS: 380x235x405 mm
CAPACITY: 7 lt
POWER: 500 Watt
SPEED: Adjustable 0-1 000 prn

INFO

Stainless steel construction
Max flour quantity: 750 gr
Mixing cream: 1500 gr
Included: balloon whisk, dough hook & shovel

■ **798€** + V.A.T.



B10S 500

PASTRY MIXER

DIMENSIONS: 380x235x445 mm
CAPACITY: 10 lt
POWER: 500 Watt
SPEED: Adjustable 0-1 000 prn

INFO

Stainless steel construction
Max flour quantity: 1000 gr
Mixing cream: 2000 gr
Included: balloon whisk, dough hook & shovel

■ **940 €** + V.A.T.



Kitchen Utensils



249338-249558

MAGNETIC KNIVES' RACK

249338 | 330 mm
249558 | 550 mm

■ **7 €** + V.A.T.
■ **10 €** + V.A.T.

INFO

Knives not included.



099102-105

ALUMINIUM TAP GRAPPER

099102 | 450 mm
099103 | 600 mm
099104 | 900 mm
099105 | 1200 mm

■ **12 €** + V.A.T.
■ **16 €** + V.A.T.
■ **32 €** + V.A.T.
■ **38 €** + V.A.T.



Thermometers

NEW



THE 500UN

ANALOG THERMOMETER

TEMPERATURE: -40°C up to +50°C

■ 4 € + V.A.T.

NEW



THE 005UN

DIGITAL THERMOMETER WITH PROBE

TEMPERATURE: -50°C up to +300°C

INFO

Stainless steel probe
Probe length 110 mm
Battery LR44 (included)

■ 11 € + V.A.T.



620310

DIGITAL THERMOMETER

TEMPERATURE: 0°C up to +300°C
HUMIDITY: 25% up to 95%

INFO

Batteries 3A (not included)

■ 41 € + V.A.T.

NEW



620412

DIGITAL THERMOMETER WITH CABLE & PROBE

TEMPERATURE: 0°C up to +300°C

INFO

Stainless steel probe
Cable length 100 cm
Batteries 3A (not included)

■ 68 € + V.A.T.

Trolleys

VX 1512

SERVING TROLLEY WITH 3 SHELVES

DIMENSIONS: 780x430x950 mm

■ **145 €** + V.A.T.

NEW



VE 14X

SERVING TROLLEY WITH 2 SHELVES

DIMENSIONS: 950x500x950 mm

■ **145 €** + V.A.T.

NEW



VE 15X

SERVING TROLLEY WITH 2 SHELVES

DIMENSIONS: 850x450x900 mm

■ **135 €** + V.A.T.

NEW



VE 11X

SERVING TROLLEY WITH 3 SHELVES

DIMENSIONS: 950x500x950 mm

■ **180 €** + V.A.T.

NEW



NEW



VE 121X

**SERVING TROLLEY WITH 2 SHELVES
WITH COLLECTION BASIN**

DIMENSIONS: 950x500x950 mm

■ 179 € + V.A.T.

NEW



VE 124X

**SERVING TROLLEY WITH 2 SHELVES
WITH SIDE PROTECTION**

DIMENSIONS: 950x500x950 mm

■ 150 € + V.A.T.



VE 135X

**INOX MOBILE RACK
FOR GN 1/1 CONTAINERS**

DIMENSIONS: 380x550x1735 mm

INFO

Space between trays: 75 mm
Rubber castors Ø20 cm

■ 285 € + V.A.T.



VE 131X

**INOX MOBILE RACK
FOR TRAYS 40x60 cm**

DIMENSIONS: 470x620x1735 mm

INFO

Space between trays: 75 mm
Rubber castors Ø15 cm

■ 315 € + V.A.T.



D I S P L A Y S

DISPLAYS

DISPLAY REFRIGERATORS [32]

BEER DISPLAY REFRIGERATORS SUBZERO [35]

COOLING & FREEZING [41]

FREEZING [42]

WINE [43]

COUNTERTOP [44]

SUSHI [54]

NEUTRAL [55]

REFRIGERATED DISPLAYS [56]

ICE CREAM [60]

Display refrigerators

VCB 375

DISPLAY REFRIGERATOR

DIMENSIONS: 615x600x1950 mm
TEMPERATURE: +1 up to +10°C
CAPACITY: 375 lt
COOLING: Ventilated
DEFROST: Manual
POWER: 300 Watt
REFRIGERANT: R600a
THERMOSTAT: Analog
SHELVES: 4 adjustable

INFO

Lock
Led illumination
Canopy illumination
Door opening left to right

■ **890 €** + V.A.T.



VCB 460

DISPLAY REFRIGERATOR

DIMENSIONS: 620x600x2000 mm
TEMPERATURE: +1 up to +10°C
CAPACITY: 400 lt
COOLING: Ventilated
DEFROST: Manual
POWER: 300 Watt
REFRIGERANT: R600a
THERMOSTAT: Analog
SHELVES: 4 adjustable

INFO

Lock
Led illumination
Canopy illumination
Door opening left to right
Electronic temperature display

■ **1.040 €** + V.A.T.



Electronic temperature display

VCB 400B (frameless)

DISPLAY REFRIGERATOR

DIMENSIONS: 595x620x1830 mm
TEMPERATURE: +1 up to +10°C
CAPACITY: 385 lt
COOLING: Ventilated
DEFROST: Manual
POWER: 300 Watt
REFRIGERANT: R600a
THERMOSTAT: Analog
SHELVES: 5 adjustable

INFO

Lock
Led illumination
Canopy illumination
"Frameless" door, opening left to right
Analog temperature indicator
Colour: black internal & external

■ **1.095 €** + V.A.T.



NEW



DBC 392BL

DISPLAY REFRIGERATOR

DIMENSIONS: 610x600x1980 mm
TEMPERATURE: +1 up to +10°C
CAPACITY: 320 lt
COOLING: Static with ventilator
DEFROST: Manual
POWER: 160 Watt
REFRIGERANT: R600
THERMOSTAT: Analog
SHELVES: 4 adjustable

INFO

Lock
Led illumination
Canopy illumination
Door opening left to right
Colour: white internal & black external

■ 820 € + V.A.T.

NEW



DBC 170W (Slim)

DISPLAY REFRIGERATOR

DIMENSIONS: 360x385x1880 mm
TEMPERATURE: +1 up to +10°C
CAPACITY: 105 lt
COOLING: Ventilated
DEFROST: Automatic
POWER: 95 Watt
REFRIGERANT: R600
THERMOSTAT: Analog
SHELVES: 8 adjustable

INFO

Led illumination
Canopy illumination
Door opening left to right
Colour: white internal & black external

■ 875 € + V.A.T.

NEW



DBC 600BL

DISPLAY REFRIGERATOR

DIMENSIONS: 700x700x2030 mm
TEMPERATURE: +1 up to +10°C
CAPACITY: 505 lt
COOLING: Ventilated
DEFROST: Automatic
POWER: 340 Watt
REFRIGERANT: R290
THERMOSTAT: Electronic
SHELVES: 5 adjustable

INFO

Led illumination
Door opening left to right
Colour: white internal & black external

■ 1.395 € + V.A.T.

Cooling displays

SBC 120F

DISPLAY REFRIGERATOR

DIMENSIONS: 480x525x840 mm
TEMPERATURE: +1 up to +10°C
CAPACITY: 101 lt
COOLING: Static with ventilator
DEFROST: Manual
POWER: 95 Watt
REFRIGERANT: R600a
THERMOSTAT: Analog
SHELVES: 3 adjustable

INFO

Led illumination
Door opening left to right
Colour: white internal & external

■ **540 €** + V.A.T.

NEW



VF 105F

DISPLAY REFRIGERATOR

DIMENSIONS: 445x510x831 mm
TEMPERATURE: +1 up to +10°C
CAPACITY: 92 lt
COOLING: Static with ventilator
DEFROST: Manual
POWER: 95 Watt
REFRIGERANT: R600a
THERMOSTAT: Analog
SHELVES: 4 adjustable

INFO

Led illumination
Door opening left to right
Colour: black internal & external

■ **430 €** + V.A.T.



Beer cooling displays



SZB 380

BEER DISPLAY REFRIGERATOR SUBZERO

DIMENSIONS: 615x610x1950 mm
TEMPERATURE: -5 up to 0°C
CAPACITY: 350 lt
COOLING: Ventilated
DEFROST: Automatic
POWER: 300 Watt
REFRIGERANT: R600
THERMOSTAT: Electronic
SHELVES: 4 adjustable

INFO

Lock
Led illumination
Canopy illumination
Door opening left to right

■ **1.690 €** + V.A.T.

NEW



SZB 520

BEER DISPLAY REFRIGERATOR SUBZERO

DIMENSIONS: 700x700x2030 mm
TEMPERATURE: -3 up to +8°C
CAPACITY: 505 lt
COOLING: Ventilated
DEFROST: Automatic
POWER: 450 Watt
REFRIGERANT: R290
THERMOSTAT: Electronic
SHELVES: 5 adjustable

INFO

Led illumination
Canopy illumination
Door opening left to right

■ **1.790 €** + V.A.T.

Cooling displays



DBC 600S

DISPLAY REFRIGERATOR

DIMENSIONS: 1080x595x2120 mm
TEMPERATURE: +1 up to +10°C
CAPACITY: 680 lt
COOLING: Ventilated
DEFROST: Automatic
POWER: 480 Watt
REFRIGERANT: R134/R290
THERMOSTAT: Electronic
SHELVES: 4 adjustable

INFO

Sliding doors
Led illumination
Canopy illumination
Colour: white internal & black external

■ **2.090 €** + V.A.T.

DBC 1000S

DISPLAY REFRIGERATOR

DIMENSIONS: 1220x660x2120 mm
TEMPERATURE: +1 up to +10°C
CAPACITY: 880 lt
COOLING: Ventilated
DEFROST: Automatic
POWER: 550 Watt
REFRIGERANT: R134/R290
THERMOSTAT: Electronic
SHELVES: 4 adjustable

INFO

Sliding doors
Led illumination
Canopy illumination
Colour: white internal & black external

■ **2.150 €** + V.A.T.

NEW



DBC 660H

DISPLAY REFRIGERATOR

DIMENSIONS: 1080x600x2120 mm
TEMPERATURE: +1 up to +10°C
CAPACITY: 660 lt
COOLING: Ventilated
DEFROST: Automatic
POWER: 480 Watt
REFRIGERANT: R134/R290
THERMOSTAT: Electronic
SHELVES: 4+4 adjustable

INFO

Led illumination
Revolving doors
Colour: white internal & black external

■ 1.990 € + V.A.T.

NEW



DBC 660H Black

DISPLAY REFRIGERATOR

DIMENSIONS: 1080x600x2120 mm
TEMPERATURE: +1 up to +10°C
CAPACITY: 660 lt
COOLING: Ventilated
DEFROST: Automatic
POWER: 480 Watt
REFRIGERANT: R134/R290
THERMOSTAT: Electronic
SHELVES: 4+4 adjustable

INFO

Led illumination
Revolving doors
Colour: black internal & external

■ 2.090 € + V.A.T.

Cooling displays

DBC 1100H

DISPLAY REFRIGERATOR

DIMENSIONS: 1510x685x2120 mm
CLIMATE CLASS: N
TEMPERATURE: +1 up to +10°C
CAPACITY: 1100 lt
COOLING: Ventilated
DEFROST: Automatic
POWER: 650 Watt
REFRIGERANT: R134/R290
THERMOSTAT: Electronic
DOORS: 3 revolving
SHELVES: 4+4+4 adjustable

INFO

Led illumination
Colour: white internal & black external

■ **2.980 €** + V.A.T.

NEW



DBC 1300H

DISPLAY REFRIGERATOR

DIMENSIONS: 1780x685x2120 mm
CLIMATE CLASS: N
TEMPERATURE: +1 up to +10°C
CAPACITY: 1300 lt
COOLING: Ventilated
DEFROST: Automatic
POWER: 700 Watt
REFRIGERANT: R134/R290
THERMOSTAT: Electronic
DOORS: 3 revolving
SHELVES: 4+4+4 adjustable

INFO

Led illumination
Colour: white internal & black external

■ **3.195 €** + V.A.T.

NEW



DBC 1850H

DISPLAY REFRIGERATOR

DIMENSIONS: 2450x685x2120 mm
CLIMATE CLASS: N
TEMPERATURE: +1 up to +10°C
CAPACITY: 1850 lt
COOLING: Ventilated
DEFROST: Automatic
POWER: 800 Watt
REFRIGERANT: R134/R290
THERMOSTAT: Electronic
DOORS: 4 revolving
SHELVES: 4+4+4+4 adjustable

INFO

Led illumination
Colour: white internal & black external

■ **5.290 €** + V.A.T.

NEW



NEW



DBC 1100HF (frameless)

DISPLAY REFRIGERATOR

DIMENSIONS: 1510x685x2120 mm
CLIMATE CLASS: N
TEMPERATURE: +1 up to +10°C
CAPACITY: 1100 lt
COOLING: Ventilated
DEFROST: Automatic
POWER: 650 Watt
REFRIGERANT: R134/R290
THERMOSTAT: Electronic
DOORS: 3 revolving «frameless»
SHELVES: 4+4+4 adjustable

INFO

Led illumination
Colour: white internal & black external

■ **3.450 €** + V.A.T.

NEW



DBC 1300HF (frameless)

DISPLAY REFRIGERATOR

DIMENSIONS: 1780x685x2120 mm
CLIMATE CLASS: N
TEMPERATURE: +1 up to +10°C
CAPACITY: 1300 lt
COOLING: Ventilated
DEFROST: Automatic
POWER: 700 Watt
REFRIGERANT: R134/R290
THERMOSTAT: Electronic
DOORS: 3 revolving «frameless»
SHELVES: 4+4+4 adjustable

INFO

Led illumination
Colour: white internal & black external

■ **3.790 €** + V.A.T.

NEW



DBC 1850HF (frameless)

DISPLAY REFRIGERATOR

DIMENSIONS: 2450x685x2120 mm
CLIMATE CLASS: N
TEMPERATURE: +1 up to +10°C
CAPACITY: 1850 lt
COOLING: Ventilated
DEFROST: Automatic
POWER: 800 Watt
REFRIGERANT: R134/R290
THERMOSTAT: Electronic
DOORS: 4 revolving «frameless»
SHELVES: 4+4+4+4 adjustable

INFO

Led illumination
Colour: white internal & black external

■ **5.940 €** + V.A.T.

*All refrigerated displays of DBC series are available in version with stainless steel internal and shelves..

Cooling displays

DCV 1250

DISPLAY REFRIGERATOR

DIMENSIONS: 1250x720x2045 mm
CLIMATE CLASS: N
TEMPERATURE: +1 up to +10°C
CAPACITY: 920 lt
COOLING: Ventilated
DEFROST: Automatic
POWER: 750 Watt
REFRIGERANT: R290
THERMOSTAT: Electronic
DOORS: 2 revolving
SHELVES: 4+4 adjustable

INFO

Led illumination
Aluminium door frame

■ **4.900 €** + V.A.T.

NEW



DCV 1880

DISPLAY REFRIGERATOR

DIMENSIONS: 1880x720x2045 mm
CLIMATE CLASS: N
TEMPERATURE: +1 up to +10°C
CAPACITY: 1430 lt
COOLING: Ventilated
DEFROST: Automatic
POWER: 950 Watt
REFRIGERANT: R290
THERMOSTAT: Electronic
DOORS: 3 revolving
SHELVES: 4+4+4 adjustable

INFO

Led illumination
Aluminium door frame

■ **6.250 €** + V.A.T.

NEW



DCV 2500

DISPLAY REFRIGERATOR

DIMENSIONS: 2500x720x2045 mm
CLIMATE CLASS: N
TEMPERATURE: +1 up to +10°C
CAPACITY: 1940 lt
COOLING: Ventilated
DEFROST: Automatic
POWER: 1250 Watt
REFRIGERANT: R290
THERMOSTAT: Electronic
DOORS: 4 revolving
SHELVES: 4+4+4+4 adjustable

INFO

Led illumination
Aluminium door frame

■ **8.290 €** + V.A.T.

NEW



Cooling & freezing displays

NEW



DFV 1250 (dual)

DISPLAY REFRIGERATOR

DIMENSIONS: 1250x720x2045 mm
CLIMATE CLASS: N
TEMPERATURE: -22 up to +10°C
CAPACITY: 920 lt
COOLING: Ventilated
DEFROST: Automatic
POWER: 1500 Watt
REFRIGERANT: R404
THERMOSTAT: Electronic
DOORS: 2 revolving
SHELVES: 4+4 adjustable

INFO

Led illumination
Aluminium door frame
Antifog glazing

■ 5.600 € + V.A.T.

NEW



DFV 1880 (dual)

DISPLAY REFRIGERATOR

DIMENSIONS: 1880x720x2045 mm
CLIMATE CLASS: N
TEMPERATURE: +1 up to +10°C
CAPACITY: 1430 lt
COOLING: Ventilated
DEFROST: Automatic
POWER: 1600 Watt
REFRIGERANT: R404
THERMOSTAT: Electronic
DOORS: 3 revolving
SHELVES: 4+4+4 adjustable

INFO

Led illumination
Aluminium door frame
Antifog glazing

■ 7.290 € + V.A.T.

NEW



DFV 2500 (dual)

DISPLAY REFRIGERATOR

DIMENSIONS: 2500x720x2045 mm
CLIMATE CLASS: N
TEMPERATURE: +1 up to +10°C
CAPACITY: 1940 lt
COOLING: Ventilated
DEFROST: Automatic
POWER: 1900 Watt
REFRIGERANT: R404
THERMOSTAT: Electronic
DOORS: 4 revolving
SHELVES: 4+4+4+4 adjustable

INFO

Led illumination
Aluminium door frame
Antifog glazing

■ 10.500 € + V.A.T.

Freezing displays

VF 40 BLACK

FREEZING DISPLAY

DIMENSIONS: 615x610x2030 mm
CLIMATE CLASS: ST
TEMPERATURE: -18 up to -22°C
CAPACITY: 305 lt
COOLING: Static
DEFROST: Manual
POWER: 530 Watt
REFRIGERANT: R290
THERMOSTAT: Electronic
SHELVES: 5 fixed

INFO

Led illumination
Canopy illumination

■ **1.980 €** + V.A.T.



DVF 600

FREEZING DISPLAY

DIMENSIONS: 690x705x2200 mm
CLIMATE CLASS: ST
TEMPERATURE: -18 up to -22°C
CAPACITY: 460 lt
COOLING: Ventilated
DEFROST: Automatic
POWER: 635 Watt
REFRIGERANT: R290
THERMOSTAT: Electronic
SHELVES: 4 adjustable

INFO

Led illumination
Canopy illumination

■ **2.380 €** + V.A.T.



Wine displays



VW 400

WINE DISPLAY

DIMENSIONS: 600x630x1835 mm
CAPACITY: 342 lt / 103 bottles (750 ml)
TEMPERATURE: +6 up to +14°C
COOLING: Static
DEFROST: Automatic
REFRIGERANT: R600
THERMOSTAT: Electronic
SHELVES: 7 wooden

INFO

Led illumination
Door opening left to right

■ **1.350 €** + V.A.T.



NEW



VE 120 SS/G

WINE DISPLAY

DIMENSIONS: 445x510x831 mm
CAPACITY: 92 lt / 32 bottles (750 ml)
TEMPERATURE: +6 up to +14°C
COOLING: Static
DEFROST: Automatic
REFRIGERANT: R600
THERMOSTAT: Electronic
SHELVES: 2 wooden & bottom

INFO

Led illumination

■ **670 €** + V.A.T.

Countertop displays

VE 58BL

COUNTERTOP DISPLAY

DIMENSIONS: 452x406x816 mm
CAPACITY: 58 lt
COOLING: Ventilated
DEFROST: Automatic
REFRIGERANT: R290
TEMPERATURE: +2°C / +10°C
THERMOSTAT: Electronic
SHELVES: 2 adjustable

INFO

Led illumination
Colour: Black

■ 640 € + V.A.T.



VE 58C

COUNTERTOP DISPLAY

DIMENSIONS: 452x406x816 mm
CAPACITY: 58 lt
COOLING: Ventilated
DEFROST: Automatic
REFRIGERANT: R290
TEMPERATURE: +2°C / +10°C
THERMOSTAT: Electronic
SHELVES: 2 adjustable

INFO

Led illumination
Colour: White

■ 640 € + V.A.T.



VE 78BL

COUNTERTOP DISPLAY

DIMENSIONS: 452x406x966 mm
CAPACITY: 78 lt
COOLING: Ventilated
DEFROST: Automatic
REFRIGERANT: R290
TEMPERATURE: +2°C / +10°C
THERMOSTAT: Electronic
SHELVES: 3 adjustable

INFO

Led illumination
Colour: Black

■ 680 € + V.A.T.





VE 78C

COUNTERTOP DISPLAY

DIMENSIONS: 452x406x966 mm
CAPACITY: 78 lt
COOLING: Ventilated
DEFROST: Automatic
REFRIGERANT: R290
TEMPERATURE: +2°C /+10°C
THERMOSTAT: Electronic
SHELVES: 3 adjustable

INFO

Led illumination
Colour: White

■ **680 €** + V.A.T.

Countertop refrigerated displays



VE 109BL

COUNTERTOP REFRIGERATED DISPLAY

DIMENSIONS: 682x450x675 mm
CAPACITY: 100 lt
POWER: 190 Watt
COOLING: Ventilated
DEFROST: Automatic
REFRIGERANT: R290
TEMPERATURE: +2°C /+10°C
THERMOSTAT: Electronic
SHELVES: 2 adjustable

INFO

Led illumination
Colour: Black

■ **895 €** + V.A.T.

NEW



VE 120C 2

COUNTERTOP REFRIGERATED DISPLAY

DIMENSIONS: 702x568x686 mm
CAPACITY: 120 lt
POWER: 215 Watt
COOLING: Ventilated
DEFROST: Automatic
REFRIGERANT: R290
TEMPERATURE: +2°C /+10°C
THERMOSTAT: Electronic
SHELVES: 2 adjustable

INFO

Led illumination
Doors front & back
Colour: Black

■ **1.260 €** + V.A.T.

Countertop refrigerated displays

VE 120C

COUNTERTOP DISPLAY

DIMENSIONS: 702x568x686 mm
CAPACITY: 120 lt
POWER: 215 Watt
COOLING: Ventilated
DEFROST: Automatic
REFRIGERANT: R290
TEMPERATURE: +2°C /+ 10°C
THERMOSTAT: Electronic
SHELVES: 2 adjustable

INFO

Led illumination
Colour: Black

■ **1.210 €** + V.A.T.



VE 160C

COUNTERTOP DISPLAY

DIMENSIONS: 880x568x686 mm
CAPACITY: 160 lt
POWER: 240 Watt
COOLING: Ventilated
DEFROST: Automatic
REFRIGERANT: R290
TEMPERATURE: +2°C /+ 10°C
THERMOSTAT: Electronic
SHELVES: 2 adjustable

INFO

Led illumination
Colour: Black

■ **1.340 €** + V.A.T.



VE 200C

COUNTERTOP DISPLAY

DIMENSIONS: 1220x568x686 mm
CAPACITY: 200 lt
POWER: 260 Watt
COOLING: Ventilated
DEFROST: Automatic
REFRIGERANT: R290
TEMPERATURE: +2°C /+ 10°C
THERMOSTAT: Electronic
SHELVES: 2 adjustable

INFO

Led illumination
Colour: Black

■ **1.920 €** + V.A.T.



Countertop heated displays



VE 120H

COUNTERTOP HEATED DISPLAY

DIMENSIONS: 678x568x686 mm
CAPACITY: 120 lt
POWER: 1100 Watt
TEMPERATURE: +30°C /+90°C
THERMOSTAT: Analog
SHELVES: 3 adjustable

INFO

Led illumination
Colour: Black

■ **890 €** + V.A.T.

VE 160H

COUNTERTOP HEATED DISPLAY

DIMENSIONS: 856x568x686 mm
CAPACITY: 160 lt
POWER: 1500 Watt
TEMPERATURE: +30°C /+90°C
THERMOSTAT: Analog
SHELVES: 3 adjustable

INFO

Led illumination
Colour: Black

■ **1.090 €** + V.A.T.

VE 200H

COUNTERTOP HEATED DISPLAY

DIMENSIONS: 1200x568x686 mm
CAPACITY: 200 lt
POWER: 1500 Watt
TEMPERATURE: +30°C /+90°C
THERMOSTAT: Analog
SHELVES: 3 adjustable

INFO

Led illumination
Colour: Black

■ **1.380 €** + V.A.T.

Countertop heated displays



VE 50H

COUNTERTOP HEATED DISPLAY

DIMENSIONS: 554x361x376 mm
CAPACITY: 50 lt
POWER: 800 Watt
TEMPERATURE: +30°C /+90°C
THERMOSTAT: Analog
SHELVES: 2 fixed

INFO

Stainless steel

■ 520 € + V.A.T.

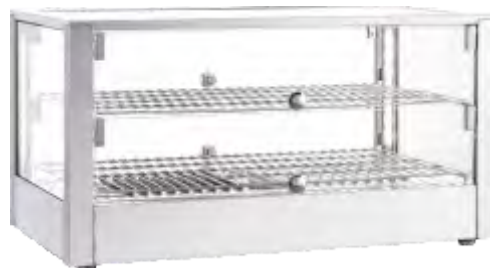

VE 80H

COUNTERTOP HEATED DISPLAY

DIMENSIONS: 700x400x376 mm
CAPACITY: 80 lt
POWER: 1 100 Watt
TEMPERATURE: +30°C /+90°C
THERMOSTAT: Analog
SHELVES: 2 fixed

INFO

Stainless steel

■ 630 € + V.A.T.

NEW



BMT 2GN

COUNTERTOP HEATED DISPLAY BAIN MARIE TYPE

DIMENSIONS: 790x690x710 mm
CAPACITY: 2 GN 1/1-65mm
POWER: 800 Watt
TEMPERATURE: +30°C /+90°C
THERMOSTAT: Analog

INFO

Water drawer
Lighting
Fans for air circulation
Display shelf

■ 1.195 € + V.A.T.

NEW



BMT 3GN

COUNTERTOP HEATED DISPLAY BAIN MARIE TYPE

DIMENSIONS: 1 140x690x710 mm
CAPACITY: 3 GN 1/1-65mm
POWER: 1 200 Watt
TEMPERATURE: +30°C /+90°C
THERMOSTAT: Analog

INFO

Water drawer
Lighting
Fans for air circulation
Display shelf

■ 1.395 € + V.A.T.

NEW



VHW 827

COUNTERTOP HEATED DISPLAY

DIMENSIONS: 660x500x620 mm
CAPACITY: 2 GN 1/2-65 mm
POWER: 800 Watt
TEMPERATURE: +30°C /+85°C
THERMOSTAT: Analog
SHELVES: 2

INFO

Colour: Black

■ 260 € + V.A.T.

NEW



VHW 350

COUNTERTOP HEATED DISPLAY

DIMENSIONS: 350x450x520 mm
POWER: 800 Watt
TEMPERATURE: +30°C /+85°C
THERMOSTAT: Analog
SHELVES: 3

INFO

Stainless steel

■ 359 € + V.A.T.

NEW



VHW 350A

COUNTERTOP HEATED DISPLAY

DIMENSIONS: 460x460x615 mm
POWER: 950 Watt
TEMPERATURE: +30°C /+85°C
THERMOSTAT: Analog
SHELVES: 3

INFO

Stainless steel

■ 590 € + V.A.T.

Countertop displays



401234

COUNTERTOP DISPLAY FOR GN 1/4 CONTAINERS

DIMENSIONS: 1200x335x435 mm
CAPACITY: 5 GN 1/4
POWER: 150 Watt
COOLING: Static
DEFROST: Automatic
REFRIGERANT: R290
TEMPERATURE: +2°C /+ 10°C
THERMOSTAT: Electronic

INFO

Stainless steel
Containers are not included

■ **710 €** + V.A.T.

401534

COUNTERTOP DISPLAY FOR GN 1/4 CONTAINERS

DIMENSIONS: 1500x335x435 mm
CAPACITY: 7 GN 1/4
POWER: 150 Watt
COOLING: Static
DEFROST: Automatic
REFRIGERANT: R290
TEMPERATURE: +2°C /+ 10°C
THERMOSTAT: Electronic

INFO

Stainless steel
Containers are not included

■ **840 €** + V.A.T.

401434

COUNTERTOP DISPLAY FOR GN 1/4 CONTAINERS

DIMENSIONS: 1400x335x435 mm
CAPACITY: 6 GN 1/4
POWER: 150 Watt
COOLING: Static
DEFROST: Automatic
REFRIGERANT: R290
TEMPERATURE: +2°C /+ 10°C
THERMOSTAT: Electronic

INFO

Stainless steel
Containers are not included

■ **795 €** + V.A.T.

401634

COUNTERTOP DISPLAY FOR GN 1/4 CONTAINERS

DIMENSIONS: 1600x335x435 mm
CAPACITY: 7 GN 1/4
POWER: 150 Watt
COOLING: Static
DEFROST: Automatic
REFRIGERANT: R290
TEMPERATURE: +2°C /+ 10°C
THERMOSTAT: Electronic

INFO

Stainless steel
Containers are not included

■ **860 €** + V.A.T.

402034

COUNTERTOP DISPLAY FOR GN 1/4 CONTAINERS

DIMENSIONS: 2000x335x435 mm
CAPACITY: 10 GN 1/4
POWER: 150 Watt
COOLING: Static
DEFROST: Automatic
REFRIGERANT: R290
TEMPERATURE: +2°C /+ 10°C
THERMOSTAT: Electronic

INFO

Stainless steel
Containers are not included

■ **960 €** + V.A.T.

401834

COUNTERTOP DISPLAY FOR GN 1/4 CONTAINERS

DIMENSIONS: 1800x335x435 mm
CAPACITY: 8 GN 1/4
POWER: 150 Watt
COOLING: Static
DEFROST: Automatic
REFRIGERANT: R290
TEMPERATURE: +2°C /+ 10°C
THERMOSTAT: Electronic

INFO

Stainless steel
Containers are not included

■ **900 €** + V.A.T.

Countertop displays



401238

COUNTERTOP DISPLAY FOR GN 1/3 CONTAINERS

DIMENSIONS: 1200x395x435 mm
CAPACITY: 4 GN 1/3
POWER: 150 Watt
COOLING: Static
DEFROST: Automatic
REFRIGERANT: R290
TEMPERATURE: +2°C /+ 10°C
THERMOSTAT: Electronic

INFO

Stainless steel
Containers are not included

■ **790 €** + V.A.T.

401538

COUNTERTOP DISPLAY FOR GN 1/3 CONTAINERS

DIMENSIONS: 1500x395x435 mm
CAPACITY: 6 GN 1/3
POWER: 150 Watt
COOLING: Static
DEFROST: Automatic
REFRIGERANT: R290
TEMPERATURE: +2°C /+ 10°C
THERMOSTAT: Electronic

INFO

Stainless steel
Containers are not included

■ **860 €** + V.A.T.

401438

COUNTERTOP DISPLAY FOR GN 1/3 CONTAINERS

DIMENSIONS: 1400x395x435 mm
CAPACITY: 6 GN 1/3
POWER: 150 Watt
COOLING: Static
DEFROST: Automatic
REFRIGERANT: R290
TEMPERATURE: +2°C /+ 10°C
THERMOSTAT: Electronic

INFO

Stainless steel
Containers are not included

■ **830 €** + V.A.T.

401638

COUNTERTOP DISPLAY FOR GN 1/3 CONTAINERS

DIMENSIONS: 1600x395x435 mm
CAPACITY: 7 GN 1/3
POWER: 150 Watt
COOLING: Static
DEFROST: Automatic
REFRIGERANT: R290
TEMPERATURE: +2°C /+ 10°C
THERMOSTAT: Electronic

INFO

Stainless steel
Containers are not included

■ **910 €** + V.A.T.

402038

COUNTERTOP DISPLAY FOR GN 1/3 CONTAINERS

DIMENSIONS: 2000x395x435 mm
CAPACITY: 9 GN 1/3
POWER: 150 Watt
COOLING: Static
DEFROST: Automatic
REFRIGERANT: R290
TEMPERATURE: +2°C /+ 10°C
THERMOSTAT: Electronic

INFO

Stainless steel
Containers are not included

■ **1.090 €** + V.A.T.

401838

COUNTERTOP DISPLAY FOR GN 1/3 CONTAINERS

DIMENSIONS: 1800x395x435 mm
CAPACITY: 8 GN 1/3
POWER: 150 Watt
COOLING: Static
DEFROST: Automatic
REFRIGERANT: R290
TEMPERATURE: +2°C /+ 10°C
THERMOSTAT: Electronic

INFO

Stainless steel
Containers are not included

■ **980 €** + V.A.T.

Sushi displays

VE 413S

SUSHI DISPLAY

DIMENSIONS: 1130x395x375 mm
CAPACITY: 4 GN 1/3
POWER: 150 Watt
COOLING: Ventilated
DEFROST: Automatic
REFRIGERANT: R290
TEMPERATURE: +2°C /+ 10°C
THERMOSTAT: Electronic

INFO

Display shelf
Led Illumination
Containers are not included

■ **1.040 €** + V.A.T.

VE 513S

SUSHI DISPLAY

DIMENSIONS: 1309x395x375 mm
CAPACITY: 5 GN 1/3
POWER: 150 Watt
COOLING: Ventilated
DEFROST: Automatic
REFRIGERANT: R290
TEMPERATURE: +2°C /+ 10°C
THERMOSTAT: Electronic

INFO

Display shelf
Led Illumination
Containers are not included

■ **1.090 €** + V.A.T.

■ **NEW**



Front



Back

VE 613S

SUSHI DISPLAY

DIMENSIONS: 1485x395x375 mm
CAPACITY: 6 GN 1/3
POWER: 160 Watt
COOLING: Ventilated
DEFROST: Automatic
REFRIGERANT: R290
TEMPERATURE: +2°C /+ 10°C
THERMOSTAT: Electronic

INFO

Display shelf
Led Illumination
Containers are not included

■ **1.140 €** + V.A.T.

VE 813S

SUSHI DISPLAY

DIMENSIONS: 1756x395x375 mm
CAPACITY: 8 GN 1/3 ó 5 GN 1/2
POWER: 170 Watt
COOLING: Ventilated
DEFROST: Automatic
REFRIGERANT: R290
TEMPERATURE: +2°C /+ 10°C
THERMOSTAT: Electronic

INFO

Display shelf
Led Illumination
Containers are not included

■ **1.230 €** + V.A.T.

Neutral displays



VE 35N

NEUTRAL DISPLAY

DIMENSIONS: 554x361x312 mm
CAPACITY: 35 lt

INFO
Stainless steel & glass

■ **190 €** + V.A.T.



VE 50N

NEUTRAL DISPLAY

DIMENSIONS: 554x361x379 mm
CAPACITY: 50 lt

INFO
Stainless steel & glass

■ **210 €** + V.A.T.

NEW



VE 100N

NEUTRAL DISPLAY

DIMENSIONS: 684x457x516 mm
CAPACITY: 100 lt

INFO
Stainless steel & glass

■ **930 €** + V.A.T.

NEW



VE 150N

NEUTRAL DISPLAY

DIMENSIONS: 989x457x516 mm
CAPACITY: 150 lt

INFO
Stainless steel & glass

■ **1.210 €** + V.A.T.

Refrigerated displays

HBS 90

REFRIGERATED DISPLAY

DIMENSIONS: 900x700x1220 mm
CAPACITY: 290 lt
POWER: 380 Watt
COOLING: Ventilated
DEFROST: Automatic
REFRIGERANT: R134/R290
TEMPERATURE: +2°C /+10°C
THERMOSTAT: Electronic
SHELVES: 2

INFO

Sliding doors
Upper & shelves' Led illumination
Colour: Black
Antifog film
Rubber castors

■ **2.980 €** + V.A.T.



HBS 120

REFRIGERATED DISPLAY

DIMENSIONS: 1200x700x1220 mm
CAPACITY: 400 lt
POWER: 450 Watt
COOLING: Ventilated
DEFROST: Automatic
REFRIGERANT: R134/R290
TEMPERATURE: +2°C /+10°C
THERMOSTAT: Electronic
SHELVES: 2

INFO

Sliding doors
Upper & shelves' Led illumination
Colour: Black
Antifog film
Rubber castors

■ **3.390 €** + V.A.T.

HBS 150

REFRIGERATED DISPLAY

DIMENSIONS: 1500x700x1220 mm
CAPACITY: 510 lt
POWER: 650 Watt
COOLING: Ventilated
DEFROST: Automatic
REFRIGERANT: R134/R290
TEMPERATURE: +2°C /+10°C
THERMOSTAT: Electronic
SHELVES: 2

INFO

Sliding doors
Upper & shelves' Led illumination
Colour: Black
Antifog film
Rubber castors

■ **3.990 €** + V.A.T.



CBS 90

REFRIGERATED HEATED DISPLAY

DIMENSIONS: 900x700x1 220 mm
CAPACITY: 290 lt
POWER: 650 Watt
TEMPERATURE: +30°C /+70°C
THERMOSTAT: Electronic
SHELVES: 2

INFO

Sliding doors
Upper & shelves' Led illumination
Rubber castors
Colour: Black

■ **1.980 €** + V.A.T.



* Refrigerated displays CBS & HBS are also available in **white colour**.

CBS 120

REFRIGERATED HEATED DISPLAY

DIMENSIONS: 1 200x700x1 220 mm
CAPACITY: 400 lt
POWER: 650 Watt
TEMPERATURE: +30°C /+70°C
THERMOSTAT: Electronic
SHELVES: 2

INFO

Sliding doors
Upper & shelves' Led illumination
Rubber castors
Colour: Black

■ **2.900 €** + V.A.T.

CBS 150

REFRIGERATED HEATED DISPLAY

DIMENSIONS: 1 500x700x1 220 mm
CAPACITY: 510 lt
POWER: 650 Watt
TEMPERATURE: +30°C /+70°C
THERMOSTAT: Electronic
SHELVES: 2

INFO

Sliding doors
Upper & shelves' Led illumination
Rubber castors
Colour: Black

■ **3.400 €** + V.A.T.

Refrigerated displays

PANORAMIC

VE 288 BL

PANORAMIC REFRIGERATED DISPLAY

DIMENSIONS: 520x485x1890 mm

TEMPERATURE: +1°C / +10°C

CLIMATE CLASS: 4

CAPACITY: 270 lt

COOLING: Ventilated

DEFROST: Automatic

REFRIGERANT: R290

THERMOSTAT: Electronic

INFO

Upper Led illumination and vertical in all corners

Adjustable laminated shelves

Color: Black

Double glazing

Castors

■ **1.680 €** + V.A.T.





VCL 250C / 250B

PANORAMIC REFRIGERATED DISPLAY

DIMENSIONS: 522x487x1860 mm
TEMPERATURE: + 1°C /+ 10°C
CLIMATE CLASS: 4
CAPACITY: 250 lt
COOLING: Ventilated
DEFROST: Automatic
REFRIGERANT: R290
THERMOSTAT: Electronic

INFO

Upper Led illumination and vertical in all corners
Adjustable laminated shelves
Double glazing
Castors

■ **2.940 €** + V.A.T.



VCL 400C / 400B

PANORAMIC REFRIGERATED DISPLAY

DIMENSIONS: 652x652x1875 mm
TEMPERATURE: + 1°C /+ 10°C
CLIMATE CLASS: 4
CAPACITY: 400 lt
COOLING: Ventilated
DEFROST: Automatic
REFRIGERANT: R290
THERMOSTAT: Electronic

INFO

Upper Led illumination and vertical in all corners
Adjustable laminated shelves
Double glazing
Castors

■ **3.600 €** + V.A.T.



VCL 600C / 600B

PANORAMIC REFRIGERATED DISPLAY

DIMENSIONS: 852x652x1890 mm
TEMPERATURE: + 1°C /+ 10°C
CLIMATE CLASS: 4
CAPACITY: 600 lt
COOLING: Ventilated
DEFROST: Automatic
REFRIGERANT: R290
THERMOSTAT: Electronic

INFO

Upper Led illumination and vertical in all corners
Adjustable laminated shelves
Double glazing
Castors

■ **4.100 €** + V.A.T.

Ice cream displays

SDF 150G

ICE CREAM DISPLAY

DIMENSIONS EXT.: 665x715x875 mm
DIMENSIONS INT.: 515x540x647 mm
CAPACITY: 120 lt
POWER: 260 Watt - 230 V
TEMPERATURE: -25°C
THERMOSTAT: Analog
COOLING: Static
REFRIGERANT: R290

INFO
Castors

■ **1.180 €** + V.A.T.

SDF 260G

ICE CREAM DISPLAY

DIMENSIONS EXT.: 990x715x875 mm
DIMENSIONS INT.: 840x540x647 mm
CAPACITY: 210 lt
POWER: 300 Watt - 230 V
TEMPERATURE: -25°C
THERMOSTAT: Analog
COOLING: Static
REFRIGERANT: R290

INFO
Castors

■ **1.290 €** + V.A.T.



SDF 360G

ICE CREAM DISPLAY

DIMENSIONS EXT.: 1260x715x875 mm
DIMENSIONS INT.: 1110x540x647 mm
CAPACITY: 290 lt
POWER: 350 Watt - 230 V
TEMPERATURE: -25°C
THERMOSTAT: Analog
COOLING: Static
REFRIGERANT: R290

INFO
Castors

■ **1.700 €** + V.A.T.

SDF 460G

ICE CREAM DISPLAY

DIMENSIONS EXT.: 1530x715x875 mm
DIMENSIONS INT.: 1380x540x647 mm
CAPACITY: 370 lt
POWER: 520 Watt - 230 V
TEMPERATURE: -25°C
THERMOSTAT: Analog
COOLING: Static
REFRIGERANT: R290

INFO
Castors

■ **1.950 €** + V.A.T.

SDF 560G

ICE CREAM DISPLAY

DIMENSIONS EXT.: 1800x715x875 mm
DIMENSIONS INT.: 1650x540x647 mm
CAPACITY: 450 lt
POWER: 580 Watt - 230 V
TEMPERATURE: -25°C
THERMOSTAT: Analog
COOLING: Static
REFRIGERANT: R290

INFO
Castors

■ **2.395 €** + V.A.T.



DFE

F R E E Z E R S

FREEZERS

CHEST FREEZERS [64]

FLAT SLIDING GLASS LID FREEZERS [66]

CURVED SLIDING GLASS LID FREEZERS [69]

VERTICAL FREEZERS [70]

BEER CHEST FREEZER [71]

Chest Freezers

ES 150

CHEST FREEZER

DIMENSIONS EXT.: 545x610x830 mm
DIMENSIONS INT.: 434x414x682 mm
CAPACITY: 100 lt
TEMPERATURE: -18 up to -25°C
POWER: 95 Watt
DEFROST: Manual
REFRIGERANT: R600a
THERMOSTAT: Analog
COLOUR: White

INFO

Illumination
Castors
Lock
Tropical Climate Class

■ **330 €** + V.A.T.



ES 241

CHEST FREEZER

DIMENSIONS EXT.: 720x678x830 mm
DIMENSIONS INT.: 600x480x692 mm
CAPACITY: 197 lt
TEMPERATURE: -18 up to -25°C
POWER: 120 Watt
DEFROST: Manual
REFRIGERANT: R600a
THERMOSTAT: Analog
COLOUR: White

INFO

Illumination
Castors
Lock
Tropical Climate Class

■ **425 €** + V.A.T.



ES 295

CHEST FREEZER

DIMENSIONS EXT.: 985x560x830 mm
DIMENSIONS INT.: 874x405x683 mm
CAPACITY: 240 lt
TEMPERATURE: -18 up to -25°C
POWER: 125 Watt
DEFROST: Manual
REFRIGERANT: R600a
THERMOSTAT: Analog
COLOUR: White

INFO

Illumination
Castors
Lock
Tropical Climate Class

■ **460 €** + V.A.T.





ES 491

CHEST FREEZER

DIMENSIONS EXT.: 1480x670x830 mm
DIMENSIONS INT.: 1342x480x675 mm
CAPACITY: 423 lt
TEMPERATURE: -18 up to -25°C
POWER: 223 Watt
DEFROST: Manual
REFRIGERANT: R290
THERMOSTAT: Analog
COLOUR: White

INFO

Illumination
Castors
Lock
Tropical Climate Class

■ **725 €** + V.A.T.



ES 790

CHEST FREEZER

DIMENSIONS EXT.: 1945x797x825 mm
DIMENSIONS INT.: 1805x615x615 mm
CAPACITY: 750 lt
TEMPERATURE: -18 up to -25°C
POWER: 450 Watt
DEFROST: Manual
REFRIGERANT: R600
THERMOSTAT: Analog
COLOUR: Gray

INFO

Illumination
Castors
Lock
Tropical Climate Class

■ **1.395 €** + V.A.T.



Sliding glass lid freezers

SDF 128

FLAT SLIDING GLASS LID FREEZER

DIMENSIONS EXT.: 590x590x995 mm

DIMENSIONS INT.: 460x460x540 mm

CAPACITY: 128 lt

TEMPERATURE: -22°C

DEFROST: Manual

REFRIGERANT: R290/R600

THERMOSTAT: Analog

SLIDING GLASSES: 2

COLOUR: White

INFO

Castors

Climate class ST

■ **610 €** + V.A.T.



SDF 168

FLAT SLIDING GLASS LID FREEZER

DIMENSIONS EXT.: 930x590x850 mm

DIMENSIONS INT.: 806x460x437 mm

CAPACITY: 168 lt

TEMPERATURE: -22°C

DEFROST: Manual

REFRIGERANT: R290/R600

THERMOSTAT: Analog

SLIDING GLASSES: 2

COLOUR: White

INFO

Castors

Climate class ST

■ **650 €** + V.A.T.

SDW 240

FLAT SLIDING GLASS LID FREEZER

DIMENSIONS EXT.: 795x565x835 mm
DIMENSIONS INT.: 651x421x649 mm
CAPACITY: 165 lt
TEMPERATURE: -22°C
DEFROST: Manual
REFRIGERANT: R600
POWER: 120 Watt
THERMOSTAT: Analog
SLIDING GLASSES: 2
BASKET: 1
COLOUR: White

INFO

Castors
Climate class ST

■ **630 €** + V.A.T.



SDW 340

FLAT SLIDING GLASS LID FREEZER

DIMENSIONS EXT.: 1115x625x835 mm
DIMENSIONS INT.: 971x481x644 mm
CAPACITY: 275 lt
TEMPERATURE: -22°C
DEFROST: Manual
REFRIGERANT: R290
POWER: 190 Watt
THERMOSTAT: Analog
SLIDING GLASSES: 2
BASKET: 1
COLOUR: White

INFO

Castors
Climate class ST

■ **790 €** + V.A.T.

SDW 400

FLAT SLIDING GLASS LID FREEZER

DIMENSIONS EXT.: 1375x635x880 mm
DIMENSIONS INT.: 1256x521x451 mm
CAPACITY: 295 lt
TEMPERATURE: -22°C
DEFROST: Manual
REFRIGERANT: R290/R600
POWER: 290 Watt
THERMOSTAT: Analog
SLIDING GLASSES: 2
BASKET: 1
COLOUR: White

INFO

Castors
Climate class ST

■ **980 €** + V.A.T.

Sliding glass lid freezers



SDW 550

FLAT SLIDING GLASS LID FREEZER

DIMENSIONS EXT.: 1445x665x805 mm

DIMENSIONS INT.: 1318x538x606 mm

CAPACITY: 383 lt

TEMPERATURE: -22°C

DEFROST: Manual

REFRIGERANT: R290/R600

THERMOSTAT: Analog

SLIDING GLASSES: 2

BASKET: 1

COLOUR: White

INFO

Castors

Climate class ST

■ **1.340€** + V.A.T.

SDW 650

FLAT SLIDING GLASS LID FREEZER

DIMENSIONS EXT.: 1695x665x805 mm

DIMENSIONS INT.: 1568x538x606 mm

CAPACITY: 464 lt

TEMPERATURE: -22°C

DEFROST: Manual

REFRIGERANT: R290/R600

THERMOSTAT: Analog

SLIDING GLASSES: 3

BASKET: 1

COLOUR: White

INFO

Castors

Climate class ST

■ **1.490€** + V.A.T.

SDC 538

CURVED SLIDING GLASS LID FREEZER

DIMENSIONS EXT.: 1475x765x895 mm
DIMENSIONS INT.: 1326x606x672 mm
CAPACITY: 468 lt
TEMPERATURE: -18°C
DEFROST: Manual
REFRIGERANT: R290
POWER: 300 Watt
THERMOSTAT: Analog
SLIDING GLASSES: 2
BASKETS: 5
COLOUR: Gray

INFO

Castors
Climate class ST
Digital temperature indicator
Led Illumination

■ **1.750 €** + V.A.T.

SDC 768

CURVED SLIDING GLASS LID FREEZER

DIMENSIONS EXT.: 2000x765x895 mm
DIMENSIONS INT.: 1851x606x672 mm
CAPACITY: 672 lt
TEMPERATURE: -18°C
DEFROST: Manual
REFRIGERANT: R290
POWER: 390 Watt
THERMOSTAT: Analog
SLIDING GLASSES: 3
BASKETS: 7
COLOUR: Gray

INFO

Castors
Climate class ST
Digital temperature indicator
Led Illumination

■ **2.080 €** + V.A.T.



Vertical freezers

VF 110 SILVER

VERTICAL FREEZERS WITH SHELVES

DIMENSIONS: 526x531x831 mm
CAPACITY: 88 lt
COOLING: Static - refrigerated shelves
DEFROST: Manual
TEMPERATURE: -22°C
REFRIGERANT: R600
THERMOSTAT: Analog
SHELVES: 3
COLOUR: Gray with silver door

■ **560 €** + V.A.T.



VF 230 SILVER

VERTICAL FREEZERS WITH SHELVES

DIMENSIONS: 549x560x1636 mm
CAPACITY: 198 lt
COOLING: Static - refrigerated shelves
DEFROST: Manual
TEMPERATURE: -22°C
REFRIGERANT: R600
THERMOSTAT: Analog
SHELVES: 7
COLOUR: Gray with silver door

■ **870 €** + V.A.T.



- Χωρητικότητα 80 φιάλες 600 ml



- Ηλεκτρονικό όργανο



- Ανεμιστήρας κυκλοφορίας ψύξης



BFC 300

BEER CHEST FREEZER

DIMENSIONS: 965x595x885 mm
CAPACITY: 218 lt / 80 bottles (600ml)
COOLING: Static with auxiliary fan
DEFROST: Automatic
TEMPERATURE: -3 up to +3°C
REFRIGERANT: R600
POWER: 150 Watt
THERMOSTAT: Electronic
COLOUR: White

INFO

Castors
Lock
5 baskets suitable for beers
Climate class ST

- **750 €** + V.A.T.





C O O K I N G

OVENS

CONVECTION ELECTRIC OVENS [74]

COMBI OVENS

GALILEI SERIES [79]

VESPUCCI SERIES [86]

COLOMBO EXPLORA SERIES [90]

CONDENSATION HOODS [94]

PROVERS [95]

PIZZA OVENS [96]

TRAYS & GRILLS [98]

OVEN CLEANERS [102]

EXPLORA

PIRON[®]
your professional cooking

BakePro
FOOD SERVICE SOLUTIONS

Convection electric ovens

Series
ECO

BakePro
FOOD SERVICE SOLUTIONS

BC 45

CONVECTION ELECTRIC OVEN ANALOG

DIMENSIONS: 580x570x510 mm
CAPACITY: 4 grills 450x330 mm
or 4 trays 435x330 mm
SPACE BETWEEN TRAYS: 72 mm
POWER: 2,8 kW - 230 V
TEMPERATURE: 65 - 250°C
FANS: 1 non-auto reverse rotation

INFO

Stainless steel casing
Grills included
Trays not included

■ **720 €** + V.A.T.



BC 45H

CONVECTION ELECTRIC OVEN ANALOG

DIMENSIONS: 580x570x510 mm
CAPACITY: 4 grills 450x330 mm
or 4 trays 435x330 mm
SPACE BETWEEN TRAYS: 72 mm
POWER: 2,8 kW - 230 V
TEMPERATURE: 65 - 250°C
FANS: 2 non-auto reverse rotation

INFO

Humidity injection
Stainless steel casing
Grills included
Trays not included

■ **880 €** + V.A.T.





REVERSE AIR FLOW

Multiple fans with auto-reverse intensify the air flow in the cooking chamber.



SATOR STEAM

Patented technology from Piron that generates steam up to 100% saturation in the chamber through the creation of a fine water mist.

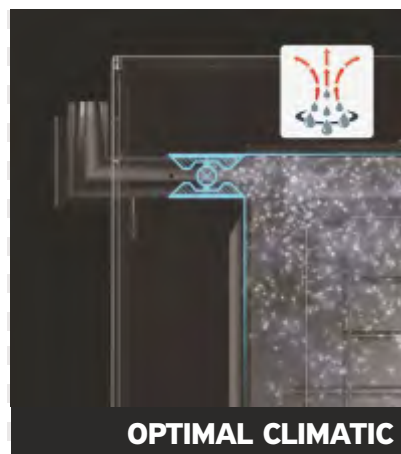

OPTIMAL CLIMATIC

System extracting the excess humidity, maintaining the desired humidity level.

PF 5804

CONVECTION ELECTRIC OVEN ANALOG

DIMENSIONS: 550x600x540 mm
CAPACITY: 4 trays 442x325 mm
SPACE BETWEEN TRAYS: 75 mm
POWER: 2,8 kW - 230 V
TEMPERATURE: 30 - 260°C
FANS: 1 non-auto reverse rotation

INFO

Stainless steel casing
Trays included

■ **930 €** + V.A.T.



PF 5804U

CONVECTION ELECTRIC OVEN ANALOG

DIMENSIONS: 550x600x540 mm
CAPACITY: 4 trays 442x325 mm
SPACE BETWEEN TRAYS: 75 mm
POWER: 2,8 kW - 230 V
TEMPERATURE: 30 - 260°C
FANS: 1 non-auto reverse rotation

INFO

Stainless steel casing
Humidity injection
Trays included

■ **995 €** + V.A.T.

Convection electric ovens

PF 5004P

CONVECTION ELECTRIC OVEN ANALOG

DIMENSIONS: 600x600x540 mm
CAPACITY: 4 trays 480x345 mm
SPACE BETWEEN TRAYS: 75 mm
POWER: 3,3 kW - 230 V
TEMPERATURE: 30 - 260°C
FANS: 2 non-auto reverse rotation

INFO

Stainless steel casing
Humidity injection
Grill
Trays included

■ 1.300 € + V.A.T.



PF 6204

CONVECTION ELECTRIC OVEN ANALOG

DIMENSIONS: 600x680x540 mm
CAPACITY: 4 trays 442x325 mm & GN 2/3
SPACE BETWEEN TRAYS: 78 mm
POWER: 3,1 kW - 230 V
TEMPERATURE: 30 - 260°C
FANS: 1 auto-reverse rotation

INFO

Stainless steel casing
Humidity injection
Trays included

■ 1.290 € + V.A.T.



PF 6204D

CONVECTION ELECTRIC OVEN DIGITAL

DIMENSIONS: 600x680x540 mm
CAPACITY: 4 trays 442x325 mm & GN 2/3
SPACE BETWEEN TRAYS: 78 mm
POWER: 3,1 kW - 230 V
TEMPERATURE: 30 - 260°C
FANS: 1 auto-reverse rotation

INFO

Stainless steel casing
Humidity injection
99 recipes with 3 phases
Preheating function
Trays included

■ 1.690 € + V.A.T.





PF 7504

CONVECTION ELECTRIC OVEN ANALOG

DIMENSIONS: 750x720x540 mm
CAPACITY: 4 trays 40x60 cm & GN 1/1
SPACE BETWEEN TRAYS: 75 mm
POWER: 6,3 kW - 230/400 V
TEMPERATURE: 30 - 260°C
FANS: 2 non-auto reverse rotation

INFO

Stainless steel casing
Humidity injection
Trays not included

■ **1.620 €** + V.A.T.



PF 7504G

CONVECTION ELECTRIC OVEN ANALOG

DIMENSIONS: 750x720x540 mm
CAPACITY: 4 trays 40x60 cm & GN 1/1
SPACE BETWEEN TRAYS: 75 mm
POWER: 6,3 kW - 230/400 V
TEMPERATURE: 30 - 260°C
FANS: 2 non-auto reverse rotation

INFO

Stainless steel casing
Humidity injection
Grill
Trays not included

■ **1.750 €** + V.A.T.



PF 7604

CONVECTION ELECTRIC OVEN DIGITAL

DIMENSIONS: 750x720x540 mm
CAPACITY: 4 trays 40x60 cm & GN 1/1
SPACE BETWEEN TRAYS: 75 mm
POWER: 6,3 kW - 230/400 V
TEMPERATURE: 30 - 260°C
FANS: 2 auto-reverse rotation

INFO

Stainless steel casing
Humidity injection
Trays not included

■ **1.930 €** + V.A.T.

Convection electric ovens

Series
CABOTO

 100% MADE IN ITALY

PF 8004 HEAVY DUTY

CONVECTION ELECTRIC OVEN ANALOG

DIMENSIONS: 800x760x540 mm
CAPACITY: 4 trays 40x60 cm & GN 1/1
SPACE BETWEEN TRAYS: 75 mm
POWER: 6,5 kW - 230/400 V
TEMPERATURE: 30 - 260°C
FANS: 2 auto-reverse rotation

INFO

Stainless steel casing
Humidity injection
Trays not included

■ **2.180 €** + V.A.T.



PF 8004D HEAVY DUTY

CONVECTION ELECTRIC OVEN DIGITAL

DIMENSIONS: 800x760x540 mm
CAPACITY: 4 trays 40x60 cm & GN 1/1
SPACE BETWEEN TRAYS: 75 mm
POWER: 6,5 kW - 230/400 V
TEMPERATURE: 30 - 260°C
FANS: 2 auto-reverse rotation

INFO

Stainless steel casing
Humidity injection
99 recipes with 3 phases
Preheating function
Trays not included

■ **2.495 €** + V.A.T.



Combi Ovens

Series **PIRON**[®]
GALILEI LITE your professional cooking

 100% MADE IN ITALY



PF 8306

COMBI OVEN ANALOG

DIMENSIONS: 780x850x830 mm
CAPACITY: 6 trays 40x60 cm & GN 1/1
SPACE BETWEEN TRAYS: 80 mm
POWER: 10,5 kW - 400 V
TEMPERATURE: 30 - 260°C
FANS: 2 auto-reverse rotation

INFO

Stainless steel casing
Analog steam percentage regulation
Trays not included

EXTRA

Reverse door opening 360 € + V.A.T.

■ **3.950 €** + V.A.T.



PF 8310

COMBI OVEN ANALOG

DIMENSIONS: 780x850x1200 mm
CAPACITY: 10 trays 40x60 cm & GN 1/1
SPACE BETWEEN TRAYS: 80 mm
POWER: 15,7 kW - 400 V
TEMPERATURE: 30 - 260°C
FANS: 3 auto-reverse rotation

INFO

Stainless steel casing
Analog steam percentage regulation
Trays not included

EXTRA

Reverse door opening 360 € + V.A.T.

■ **4.700 €** + V.A.T.

Combi Ovens

Series
GALILEI DIGITAL

 100% MADE IN ITALY

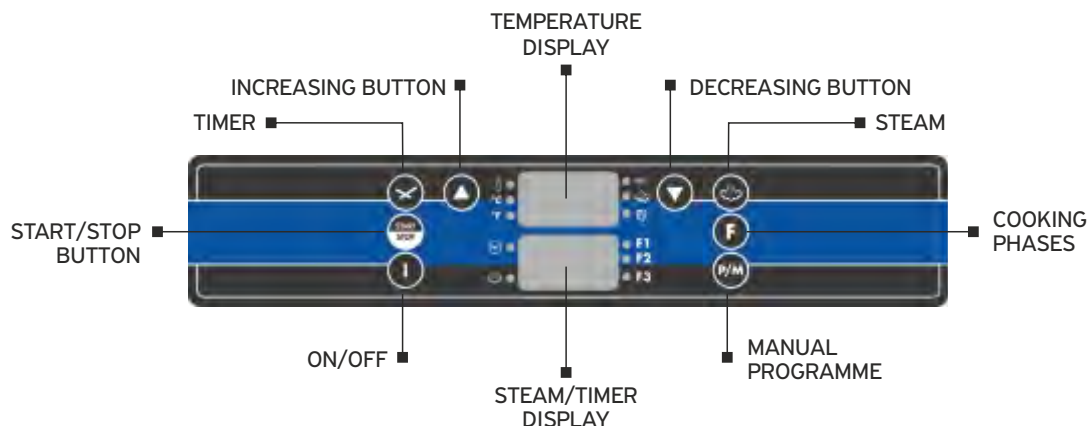

PF 8206

COMBI OVEN DIGITAL

DIMENSIONS: 780x850x830 mm
CAPACITY: 6 trays 40x60 cm & GN 1/1
SPACE BETWEEN TRAYS: 80 mm
POWER: 10,5 kW - 400 V
TEMPERATURE: 30 - 260°C
FANS: 2 auto-reverse rotation

INFO

Stainless steel casing
Digital steam percentage regulation
99 recipes with 3 phases
Preheating function
Trays not included

EXTRA

Reverse door opening 360 € + V.A.T.

■ **4.290 €** + V.A.T.



PF 8210

COMBI OVEN DIGITAL

DIMENSIONS: 780x850x1200 mm
CAPACITY: 10 trays 40x60 cm & GN 1/1
SPACE BETWEEN TRAYS: 80 mm
POWER: 15,7 kW - 400 V
TEMPERATURE: 30 - 260°C
FANS: 3 auto-reverse rotation

INFO

Stainless steel casing
Digital steam percentage regulation
99 recipes with 3 phases
Preheating function
Trays not included

EXTRA

Reverse door opening 360 € + V.A.T.

■ **5.150 €** + V.A.T.





PF 7404

COMBI OVEN ANALOG

DIMENSIONS: 760x720x570 mm
CAPACITY: 4 trays 40x60 cm & GN 1/1
SPACE BETWEEN TRAYS: 75 mm
POWER: 6,3 kW - 230/400 V
TEMPERATURE: 30 - 260°C
FANS: 2 auto-reverse rotation
FANS SPEED: 3 levels

INFO

Stainless steel casing
Analog steam percentage regulation
Trays not included

EXTRA

Reverse door opening 360 € + V.A.T.

■ **2.690 €** + V.A.T.

PF 8406

COMBI OVEN ANALOG

DIMENSIONS: 780x850x830 mm
CAPACITY: 6 trays 40x60 cm & GN 1/1
SPACE BETWEEN TRAYS: 80 mm
POWER: 10,5 kW - 230/400 V
TEMPERATURE: 30 - 260°C
FANS: 2 auto-reverse rotation
FANS SPEED: 3 levels

INFO

Stainless steel casing
Analog steam percentage regulation
Trays not included

EXTRA

Reverse door opening 360 € + V.A.T.

■ **4.180 €** + V.A.T.



PF 8410

COMBI OVEN ANALOG

DIMENSIONS: 780x850x1200 mm
CAPACITY: 10 trays 40x60 cm & GN 1/1
SPACE BETWEEN TRAYS: 80 mm
POWER: 15,7 kW - 400 V
TEMPERATURE: 30 - 260°C
FANS: 3 auto-reverse rotation
FANS SPEED: 3 levels

INFO

Stainless steel casing
Analog steam percentage regulation
Trays not included

EXTRA

Reverse door opening 360 € + V.A.T.

■ **5.080 €** + V.A.T.



Combi Ovens



PF 7706

COMBI OVEN ANALOG

DIMENSIONS: 780x850x830 mm
CAPACITY: 6 trays 40x60 cm & GN 1/1
SPACE BETWEEN TRAYS: 80 mm
POWER: 10,5 kW - 230/400 V
TEMPERATURE: 30 - 260°C
FANS: 2 auto-reverse rotation
FANS SPEED: 3 levels

INFO

Stainless steel casing
Analog steam percentage regulation
Single point core probe
Adjustable tamper
Trays not included

EXTRA

Reverse door opening 360 € + V.A.T.

■ **4.750 €** + V.A.T.



PF 7710

COMBI OVEN ANALOG

DIMENSIONS: 780x850x1200 mm
CAPACITY: 10 trays 40x60 cm & GN 1/1
SPACE BETWEEN TRAYS: 80 mm
POWER: 15,7 kW - 400 V
TEMPERATURE: 30 - 260°C
FANS: 3 auto-reverse rotation
FANS SPEED: 3 levels

INFO

Stainless steel casing
Analog steam percentage regulation
Single point core probe
Adjustable tamper
Trays not included

EXTRA

Reverse door opening 360 € + V.A.T.

■ **5.890 €** + V.A.T.



Series
GALILEI PLUS

PIRON[®]
your professional cooking



100% MADE IN ITALY



PF 7716

COMBI OVEN ANALOG

DIMENSIONS: 940x1000x1930 mm
CAPACITY: 1 trolley for 16 trays 40x60 cm
SPACE BETWEEN TRAYS: 80 mm
POWER: 36 kW - 400 V
TEMPERATURE: 30 - 260°C
FANS: 4 auto-reverse rotation
FANS SPEED: 3 levels

INFO

Stainless steel casing
Analog steam percentage regulation
Single point core probe
Adjustable tamper
Trays not included

EXTRA

Reverse door opening 360 € + V.A.T.

■ **15.100 €** + V.A.T.

PF 7720

COMBI OVEN ANALOG

DIMENSIONS: 940x1000x1930 mm
CAPACITY: 1 trolley for 20 GN 1/1
SPACE BETWEEN TRAYS: 66 mm
POWER: 36 kW - 400 V
TEMPERATURE: 30 - 260°C
FANS: 4 auto-reverse rotation
FANS SPEED: 3 levels

INFO

Stainless steel casing
Analog steam percentage regulation
Single point core probe
Adjustable tamper
Trays not included

EXTRA

Reverse door opening 360 € + V.A.T.

■ **15.100 €** + V.A.T.

COOKING
OVENS

83

Combi Ovens

PF 1565

COMBI OVEN ANALOG

DIMENSIONS: 540x680x760 mm
CAPACITY: 5 GN 2/3
SPACE BETWEEN TRAYS: 80 mm
POWER: 6 kW - 230/400 V
TEMPERATURE: 30 - 260°C
FANS: 1 auto-reverse rotation
FANS SPEED: 3 levels

INFO

Stainless steel casing
Analog steam percentage regulation
Single point core probe
Adjustable tamper
Trays not included

EXTRA

Reverse door opening 360 € + V.A.T.

■ **4.820 €** + V.A.T.



PF 1555

COMBI OVEN ANALOG

DIMENSIONS: 540x860x760 mm
CAPACITY: 5 GN 1/1
SPACE BETWEEN TRAYS: 80 mm
POWER: 7,8 kW - 230/400 V
TEMPERATURE: 30 - 260°C
FANS: 1 auto-reverse rotation
FANS SPEED: 3 levels

INFO

Stainless steel casing
Analog steam percentage regulation
Single point core probe
Adjustable tamper
Trays not included

EXTRA

Reverse door opening 360 € + V.A.T.

■ **5.100 €** + V.A.T.





PF 1550

COMBI OVEN ANALOG

DIMENSIONS: 540x860x1160 mm
CAPACITY: 10 GN 1/1
SPACE BETWEEN TRAYS: 80 mm
POWER: 15,5 kW - 400 V
TEMPERATURE: 30 - 260°C
FANS: 2 auto-reverse rotation
FANS SPEED: 3 levels

INFO

Stainless steel casing
Analog steam percentage regulation
Single point core probe
Adjustable tamper
Trays not included

EXTRA

Reverse door opening 360 € + V.A.T.

■ **6.290 €** + V.A.T.



Combi Steamer Ovens

PF 7204

COMBI STEAMER OVEN

DIMENSIONS: 780x850x640 mm
CAPACITY: 4 trays 40x60 cm & GN 1/1
SPACE BETWEEN TRAYS: 75 mm
POWER: 6,3 kW - 230/400 V
TEMPERATURE: 30 - 260°C
FANS: 2 auto-reverse rotation
FANS SPEED: 3 levels

INFO

Stainless steel casing
Steam regulation up to 100%
Single point core probe
Adjustable tamper
Preheating function
99 recipes | 5 phases
Trays not included

EXTRA

KSN00030 Single core probe 190€ + V.A.T.
Reverse door opening 360 € + V.A.T.

■ **3.750 €** + V.A.T.



PF 7206

COMBI STEAMER OVEN

DIMENSIONS: 780x850x830 mm
CAPACITY: 6 trays 40x60 cm & GN 1/1
SPACE BETWEEN TRAYS: 80 mm
POWER: 10,5 kW - 230/400 V
TEMPERATURE: 30 - 260°C
FANS: 2 auto-reverse rotation
FANS SPEED: 3 levels

INFO

Stainless steel casing
Steam regulation up to 100%
Single point core probe
Adjustable tamper
Preheating function
99 recipes | 5 phases
Trays not included

EXTRA

KSN00030 Single core probe 190€ + V.A.T.
Reverse door opening 360 € + V.A.T.

■ **5.150 €** + V.A.T.





PF 7210

COMBI STEAMER OVEN

DIMENSIONS: 780x850x1200 mm
CAPACITY: 10 trays 40x60cm & GN1/1
SPACE BETWEEN TRAYS: 80 mm
POWER: 15,8 kW - 400 V
TEMPERATURE: 30 - 260°C
FANS: 3 auto-reverse rotation
FANS SPEED: 3 levels

INFO

Stainless steel casing
Steam regulation up to 100%
Single point core probe
Adjustable tamper
Preheating function
99 recipes | 5 phases
Trays not included

EXTRA

KSN00030 Single core probe 190€ + V.A.T.
Reverse door opening 360 € + V.A.T.

■ **6.150 €** + V.A.T.

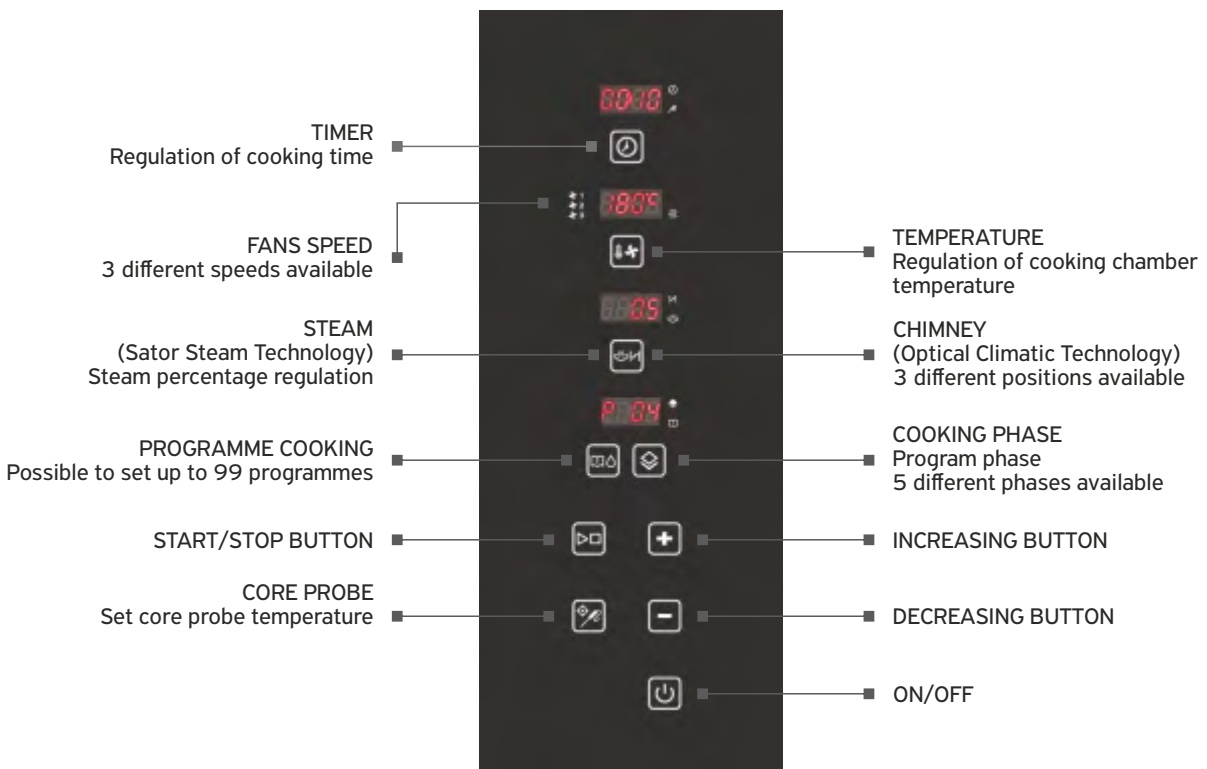

Combi Steamer Wash Ovens

PF 8904 GN

COMBI STEAMER OVEN

DIMENSIONS: 780x850x640 mm
CAPACITY: 5 GN1/1
SPACE BETWEEN TRAYS: 67 mm
POWER: 9,3 kW - 230/400 V
TEMPERATURE: 30 - 260°C
FANS: 2 auto-reverse rotation
FANS SPEED: 3 levels

INFO

Stainless steel casing
Steam regulation up to 100%
Single point core probe
Adjustable tamper
Preheating function
99 recipes | 5 phases
Built-in washing system
Trays not included

EXTRA

KSN00030 Single core probe 190€ + V.A.T.
Reverse door opening 360 € + V.A.T.

■ **4.920 €** + V.A.T.



PF 8906 GN

COMBI STEAMER OVEN

DIMENSIONS: 780x850x830 mm
CAPACITY: 7 GN1/1
SPACE BETWEEN TRAYS: 67 mm
POWER: 10,5 kW - 230/400 V
TEMPERATURE: 30 - 260°C
FANS: 2 auto-reverse rotation
FANS SPEED: 3 levels

INFO

Stainless steel casing
Steam regulation up to 100%
Single point core probe
Adjustable tamper
Preheating function
99 recipes | 5 phases
Built-in washing system
Trays not included

EXTRA

KSN00030 Single core probe 190€ + V.A.T.
Reverse door opening 360 € + V.A.T.

■ **5.830 €** + V.A.T.





PF 8910 GN

COMBI STEAMER OVEN

DIMENSIONS: 780x850x1 200 mm
CAPACITY: 12 GN1/1
SPACE BETWEEN TRAYS: 67 mm
POWER: 15,8 kW - 400 V
TEMPERATURE: 30 - 260°C
FANS: 3 auto-reverse rotation
FANS SPEED: 3 levels

INFO

Stainless steel casing
Steam regulation up to 100%
Single point core probe
Adjustable tamper
Preheating function
99 recipes | 5 phases
Built-in washing system
Trays not included

EXTRA

KSN00030 Single core probe 190€ + V.A.T.
Reverse door opening 360 € + V.A.T.

■ **7.000 €** + V.A.T.

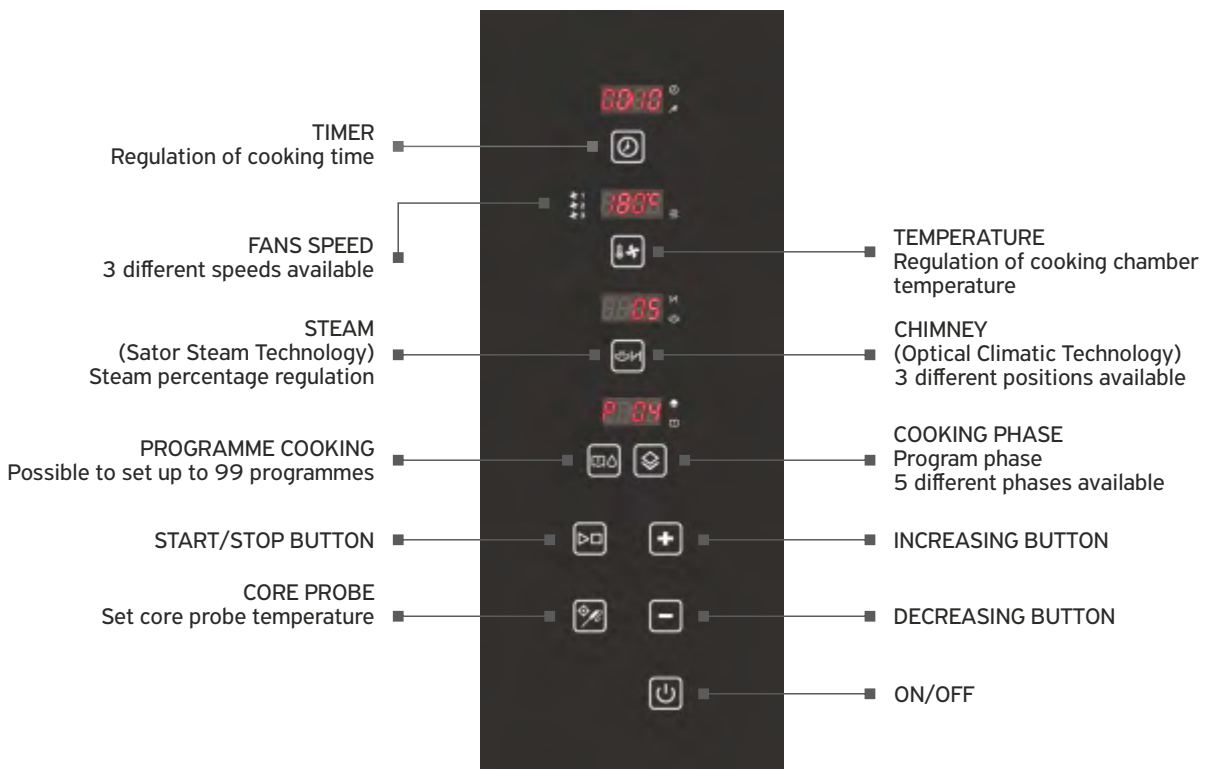

Combi Steamer Wash Ovens

PF 7904

COMBI STEAMER OVEN

DIMENSIONS: 780x850x640 mm
CAPACITY: 4 trays 40x60cm & GN1/1
SPACE BETWEEN TRAYS: 75 mm
POWER: 9,3 kW - 230/400 V
TEMPERATURE: 30 - 260°C
FANS: 2 auto-reverse rotation
FANS SPEED: 8 levels

INFO

Stainless steel casing
Steam regulation up to 100%
Control panel with 7" color touch screen
Single point core probe
Adjustable tamper
Preheating function
1000 recipes | 40 phases
Built-in washing system
Trays not included

EXTRA

Reverse door opening 360 € + V.A.T.

■ **6.290 €** + V.A.T.

EXPLORA



PF 7906

COMBI STEAMER OVEN

DIMENSIONS: 780x850x830 mm
CAPACITY: 6 trays 40x60cm & GN1/1
SPACE BETWEEN TRAYS: 80 mm
POWER: 10,5 kW - 230/400 V
TEMPERATURE: 30 - 260°C
FANS: 2 auto-reverse rotation
FANS SPEED: 8 levels

INFO

Stainless steel casing
Steam regulation up to 100%
Control panel with 7" color touch screen
Single point core probe
Adjustable tamper
Preheating function
1000 recipes | 40 phases
Built-in washing system
Trays not included

EXTRA

Reverse door opening 360 € + V.A.T.

■ **7.050 €** + V.A.T.

PF 7910

COMBI STEAMER OVEN

DIMENSIONS: 780x850x1200 mm
CAPACITY: 10 trays 40x60cm & GN1/1
SPACE BETWEEN TRAYS: 80 mm
POWER: 15,8 kW - 400 V
TEMPERATURE: 30 - 260°C
FANS: 3 auto-reverse rotation
FANS SPEED: 8 levels

INFO

Stainless steel casing
Steam regulation up to 100%
Control panel with 7" color touch screen
Single point core probe
Adjustable tamper
Preheating function
1000 recipes | 40 phases
Washing system included
Trays not included

EXTRA

Reverse door opening 360 € + V.A.T.

■ **8.250 €** + V.A.T.



PF 7916

COMBI STEAMER OVEN

DIMENSIONS: 870x1000x1930 mm
CAPACITY: 1 trolley for 16 trays 40x60 cm
SPACE BETWEEN TRAYS: 80 mm
POWER: 36 kW - 400 V
TEMPERATURE: 30 - 260°C
FANS: 4 auto-reverse rotation
FANS SPEED: 8 levels

INFO

Stainless steel casing
Steam regulation up to 100%
Control panel with 7" color touch screen
Single point core probe
Adjustable tamper
Preheating function
1000 recipes | 40 phases
Washing system included
Trays not included

EXTRA

Reverse door opening 360 € + V.A.T.

■ **17.790 €** + V.A.T.

PF 7920

COMBI STEAMER OVEN

DIMENSIONS: 870x1000x1930 mm
CAPACITY: 1 trolley for 20 GN 1/1
SPACE BETWEEN TRAYS: 66 mm
POWER: 36 kW - 400 V
TEMPERATURE: 30 - 260°C
FANS: 4 auto-reverse rotation
FANS SPEED: 8 levels

INFO

Stainless steel casing
Steam regulation up to 100%
Control panel with 7" color touch screen
Single point core probe
Adjustable tamper
Preheating function
1000 recipes | 40 phases
Washing system included
Trays not included

EXTRA

Reverse door opening 360 € + V.A.T.

■ **17.790 €** + V.A.T.

Combi Steamer Wash Ovens

Series **PIRON®**
EXPLORA COLOMBO KT Top Line your professional cooking

 100% MADE IN ITALY

PF 1545

COMBI STEAMER OVEN

DIMENSIONS: 540x680x760 mm
CAPACITY: 5 GN 2/3
SPACE BETWEEN TRAYS: 80 mm
POWER: 6,1 kW - 230/400 V
TEMPERATURE: 30 - 260°C
FANS: 1 auto-reverse rotation
FANS SPEED: 8 levels

INFO

Stainless steel casing
Steam regulation up to 100%
Control panel with 7" color touch screen
Single point core probe
Adjustable tamper
Preheating function
1000 recipes | 40 phases
Washing system included
Trays not included

EXTRA

Reverse door opening 360 € + V.A.T.

■ **6.950 €** + V.A.T.

EXPLORA

LENGTH
only
54 cm



PF 1535

COMBI STEAMER OVEN

DIMENSIONS: 540x860x760 mm
CAPACITY: 5 GN 1/1
SPACE BETWEEN TRAYS: 80 mm
POWER: 7,9 kW - 230/400 V
TEMPERATURE: 30 - 260°C
FANS: 1 auto-reverse rotation
FANS SPEED: 8 levels

INFO

Stainless steel casing
Steam regulation up to 100%
Control panel with 7" color touch screen
Single point core probe
Adjustable tamper
Preheating function
1000 recipes | 40 phases
Washing system included
Trays not included

EXTRA

Reverse door opening 360 € + V.A.T.

■ **7.450 €** + V.A.T.

PF 1530

COMBI STEAMER OVEN

DIMENSIONS: 540x860x1160 mm
CAPACITY: 10 GN 1/1
SPACE BETWEEN TRAYS: 80 mm
POWER: 15,6 kW - 400 V
TEMPERATURE: 30 - 260°C
FANS: 2 auto-reverse rotation
FANS SPEED: 8 levels

INFO

Stainless steel casing
Steam regulation up to 100%
Control panel with 7" color touch screen
Single point core probe
Adjustable tamper
Preheating function
1000 recipes | 40 phases
Washing system included
Trays not included

EXTRA

Reverse door opening 360 € + V.A.T.

■ **8.750 €** + V.A.T.



PF 1713

COMBI STEAMER OVEN

DIMENSIONS: 780x850x1200 mm
CAPACITY: 12 GN 1/1
SPACE BETWEEN TRAYS: 72 mm
POWER: 24 kW - 400 V
TEMPERATURE: 30 - 260°C
FANS: 3 auto-reverse rotation
FANS SPEED: 8 levels

INFO

Stainless steel casing
Steam regulation up to 100%
Control panel with 10" color touch screen
Single point core probe
Adjustable tamper
Preheating function
1000 recipes | 40 phases
Washing system included
Trays not included

EXTRA

Reverse door opening 360 € + V.A.T.

■ **11.900 €** + V.A.T.



PM 1764

BASE CABINET

DIMENSIONS: 780x850x700 mm

INFO

Grease collection tank
Direct connection to the oven

■ **2.400 €** + V.A.T.

KGI 00163 GN 1/1 STAINLESS STEEL GRILL FOR RIBS

DIMENSIONS: 530x325 mm Including drip teflon pan for grease

■ **450 €** + V.A.T.

KGI 01163 GN 1/1 STAINLESS STEEL GRILL FOR RIBS

DIMENSIONS: 530x325 mm Including drip stainless steel pan for grease

■ **250 €** + V.A.T.

KGI 00164 GN 1/1 STAINLESS STEEL GRILL FOR CHICKENS

DIMENSIONS: 530x325 mm Including drip teflon pan for grease

■ **450 €** + V.A.T.

KGI 01164 GN 1/1 STAINLESS STEEL GRILL FOR CHICKENS

DIMENSIONS: 530x325 mm Including drip stainless steel pan for grease

■ **250 €** + V.A.T.

TAN 00004 GN1/1 GREASE COLLECTION TANK

CAPACITY: 12 lt

■ **35 €** + V.A.T.

Condensation hoods

PIRON[®]
your professional cooking

 100% MADE IN ITALY



PC 2116

CONDENSATION HOOD

DIMENSIONS: 860x1100x230 mm
POWER: 300 Watt - 230 V

INFO

Quick and easy installation on the oven
Vapors' liquefaction and export to drainage

SUITABLE FOR:

GALILEI: PF7702 | PF7716
COLOMBO: PF7916 | PF7920

■ **2.150 €** + V.A.T.



PC 7400

CONDENSATION HOOD

DIMENSIONS: 760x890x230 mm
POWER: 300 Watt - 230 V

INFO

Quick and easy installation on the oven
Vapors' liquefaction and export to drainage

SUITABLE FOR:

GALILEI: Pf7404

■ **1.850 €** + V.A.T.



PC 7600

CONDENSATION HOOD

DIMENSIONS: 780x970x230 mm
POWER: 300 Watt - 230 V

INFO

Quick and easy installation on the oven
Vapors' liquefaction and export to drainage

SUITABLE FOR:

GALILEI: PF8206 | PF8306 | PF8406 | PF8210 | PF8310 |
PF8410 | PF7706 | PF7710 | PF7204 | PF7206 | PF7210 |
PF8904 | PF8906 | PF8906 | PF8910
COLOMBO: PF7904 | PF7906 | PF7910
PERFORMER: Pf1713

■ **2.050 €** + V.A.T.



PC 8000

CONDENSATION HOOD

DIMENSIONS: 800x950x230 mm
POWER: 300 Watt - 230 V

INFO

Quick and easy installation on the oven
Vapors' liquefaction and export to drainage

SUITABLE FOR:

CABOTO: PF8004 | PF8004D

■ **2.050 €** + V.A.T.

Provers

PIRON[®]
your professional cooking

 100% MADE IN ITALY



PL 2008

PROVER

DIMENSIONS: 810x800x950 mm
CAPACITY: 8 trays 40x60 cm & GN 1/1
POWER: 2 kW - 230 V
TEMPERATURE: 30 - 90°C

SUITABLE FOR:
CABOTO: PF7504 | PF7504G | PF7604 | PF8004 | PF8004D

■ **1.490 €** + V.A.T.

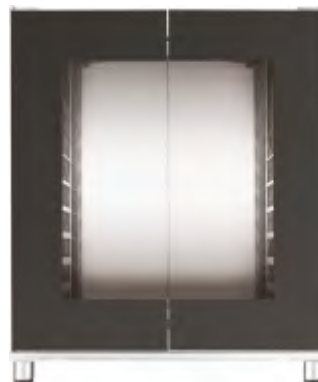

PL 6008

PROVER

DIMENSIONS: 600x600x950 mm
CAPACITY: 8 trays 44,2x32,5 cm, 48x34,5 cm & GN 2/3
POWER: 2 kW - 230 V
TEMPERATURE: 30 - 90°C

SUITABLE FOR:
CABOTO: PF5804 | PF5804U | PF6204 | PF6204D | PF5004P | BC45 | BC45H

■ **1.130 €** + V.A.T.



PL 7608

PROVER

DIMENSIONS: 780x800x950 mm
CAPACITY: 8 trays 40x60 cm & GN 1/1
POWER: 2 kW - 230 V
TEMPERATURE: 30 - 90°C

SUITABLE FOR:
GALILEI: PF8206 | PF8306 | PF8406 | PF7706
VESPUCCI: PF7204 | PF7206 | PF8904 | PF8906
COLOMBO: PF7904 | PF7906

■ **1.720 €** + V.A.T.



PL 7612

PROVER

DIMENSIONS: 780x900x600 mm
CAPACITY: 12 trays 40x60 cm & GN 1/1
POWER: 2 kW - 230 V
TEMPERATURE: 30 - 90°C

SUITABLE FOR:
GALILEI: PF8210 | PF8310 | PF8410 | PF7710
VESPUCCI: PF7710 | PF7210 | PF8910
COLOMBO: PF7910

■ **1.550 €** + V.A.T.

Pizza ovens



BP 135M

ANALOG PIZZA OVEN WITH FIREPROOF STONE (1 PIZZA)

DIMENSIONS EXT.: 580x460x280 mm
DIMENSIONS INT.: 350x350x100 mm
CAPACITY: 1 pizza Z35 cm
POWER: 2.2 kW-230V
TEMPERATURE: 65-400°C
THERMOSTATS: 2 analog (per resistance)

INFO

30' timer
Internal illumination
Fireproof stone 1.5 cm thick
Stainless steel casing

■ **650 €** + V.A.T.



BP 235M

ANALOG PIZZA OVEN WITH FIREPROOF STONE (2 PIZZA)

DIMENSIONS EXT.: 580x460x510 mm
DIMENSIONS INT.: 350x350x100 mm
CAPACITY: 2 pizza Z35 cm
POWER: 4.4 kW-230V
TEMPERATURE: 65-400°C
THERMOSTATS: 2 analog (per resistance)

INFO

30' timer
Internal illumination
Fireproof stone 1.5 cm thick
Stainless steel casing

■ **990 €** + V.A.T.



BP 135D

DIGITAL PIZZA OVEN WITH FIREPROOF STONE (1 PIZZA)

DIMENSIONS EXT.: 580x460x280 mm
DIMENSIONS INT.: 350x350x100 mm
CAPACITY: 1 pizza Z35 cm
POWER: 2.2 kW-230V
TEMPERATURE: 65-450°C
THERMOSTATS: 2 digital (per resistance)

INFO

30' timer
Internal illumination
Fireproof stone 1.5 cm thick
Stainless steel casing
6 programmes

■ **850 €** + V.A.T.



BP 235D

DIGITAL PIZZA OVEN WITH FIREPROOF STONE (2 PIZZA)

DIMENSIONS EXT.: 580x460x510 mm
DIMENSIONS INT.: 350x350x100 mm
CAPACITY: 2 pizza Z35 cm
POWER: 4.4 kW-230V
TEMPERATURE: 65-450°C
THERMOSTATS: 2 digital (per resistance)

INFO

30' timer
Internal illumination
Fireproof stone 1.5 cm thick
Stainless steel casing
6 programmes

■ **1.390 €** + V.A.T.

Trays & Grills

LEC 4333

ALUMINIUM TRAY

DIMENSIONS: 460x330x15 mm

SUITABLE FOR:
BAKEPRO BC45 | BC45H

■ **15 €** + V.A.T.



LEC 30003

ALUMINIUM TRAY

DIMENSIONS: 442x325x15 mm

SUITABLE FOR:
Piron PF5804 | PF5804U | PF6204 | PF6204D

■ **28 €** + V.A.T.



LEC 30037

ALUMINIUM TRAY

DIMENSIONS: 480x345x8 mm

SUITABLE FOR:
Piron PF5004P

■ **30 €** + V.A.T.



LEC 30001

ALUMINIUM TRAY

DIMENSIONS: 600x400x20 mm

■ **48 €** + V.A.T.



LEC 6040B

ALUMINIUM TRAY

DIMENSIONS: 600x400x20 mm

■ **28 €** + V.A.T.



LEC 30005

ALUMINIUM PERFORATED TRAY

DIMENSIONS: 442x325x15 mm

■ **28 €** + V.A.T.





LEC 30010

ALUMINIUM PERFORATED TRAY

DIMENSIONS: 600x400x20 mm

■ **45 €** + V.A.T.



LEC 30004

ALUMINIUM TRAY FOR BAGUETTES 5 CANALS

DIMENSIONS: 600x400x5 mm

■ **75 €** + V.A.T.



LEC 30006

ALUMINIUM TEFLON TRAY NON STICK

DIMENSIONS: 442x325x20 mm

■ **55 €** + V.A.T.

LEC 300012

ALUMINIUM TEFLON TRAY NON STICK

DIMENSIONS: 600x400x20 mm

■ **80 €** + V.A.T.

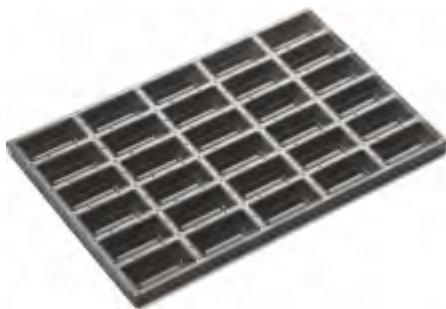

LEC 30028

ALUMINIUM TEFLON TRAY NON STICK 30 PLUM CAKES

DIMENSIONS: 600x400x20 mm

■ **250 €** + V.A.T.



LEC 30029

ALUMINIUM TEFLON TRAY NON STICK 8 EGGS

DIMENSIONS: 600x400x20 mm

■ **135 €** + V.A.T.

Trays & Grills

LEC 30040

GN 1/1 FRYING TRAY

DIMENSIONS: 530x325 mm

■ **175 €** + V.A.T.



LEC 30062

GN 1/1 NON STICK TRAY WITH STRIPES

DIMENSIONS: 530x325 mm

■ **300 €** + V.A.T.



GRI 30037

GN 1/1 STAINLESS STEEL GRID FOR CHICKEN

DIMENSIONS: 530x325x140 mm

■ **135 €** + V.A.T. (minimum order 10 pcs)



GRI 30124

GN 1/1 ALUMINIUM ANTISTICK GRILL

DIMENSIONS: 530x325 mm

■ **270 €** + V.A.T. (minimum order 10 pcs)



GRI 30006

CHROME PLATED GRID

DIMENSIONS: 442x325 mm

SUITABLE FOR:
Piron PF5804 | PF5804U | PF6204 | PF6204D

■ **18 €** + V.A.T.



GRI 48345

CHROME PLATED GRID

DIMENSIONS: 480x345 mm

SUITABLE FOR:
Piron PF5004P

■ **21 €** + V.A.T.



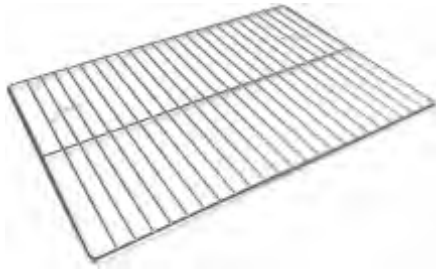

GRI 30005

CHROME PLATED GRID

DIMENSIONS: 600x400 mm

■ 22 € + V.A.T.



KGI 00163

GN 1/1 STAINLESS STEEL GRILL FOR RIBS

DIMENSIONS: 530x325 mm

INFO
Including drip teflon pan for grease

■ 450 € + V.A.T.



KGI 01163

GN 1/1 STAINLESS STEEL GRILL FOR RIBS

DIMENSIONS: 530x325 mm

INFO
Including drip stainless steel pan for grease

■ 250 € + V.A.T.



KGI 00164

GN 1/1 STAINLESS STEEL GRILL FOR CHICKENS

DIMENSIONS: 530x325 mm

INFO
Including drip teflon pan for grease

■ 450 € + V.A.T.



KGI 01164

GN 1/1 STAINLESS STEEL GRILL FOR CHICKENS

DIMENSIONS: 530x325 mm

INFO
Including drip stainless steel pan for grease

■ 250 € + V.A.T.

Oven cleansers

DET 30011

2in1 OVEN CLEANER / 1kg
DETERGENT & RINSE

SUITABLE FOR:

Piron Vespucci PF8904 | PF8906 | PF8910

INFO

Available in package of 12 tanks

■ **18 €** + V.A.T.



DET 30010

ΚΑΘΑΡΙΣΤΙΚΟ 2σε1 / 5kg
DETERGENT & RINSE

SUITABLE FOR:

Piron Vespucci PF8904 | PF8906 | PF8910

■ **75 €** + V.A.T.



DET 30004

OVEN DETERGENT 12 kg

SUITABLE FOR:

Piron Explora Colombo PF7904 | PF7906 | PF7910
PF7916 | PF7920 | PF1530|PF1535 | PF1545
Piron Explora Performer PF1713

■ **125 €** + V.A.T.



BRI 30002

OVEN RINSE 10 kg

SUITABLE FOR:

Piron Explora Colombo PF7904 | PF7906 | PF7910
PF7916 |PF7920 |PF1530|PF1535|PF1545
Piron Explora Performer PF1713

■ **105 €** + V.A.T.



KDC 00020

SHOWER

SUITABLE FOR:

Piron Galilei PF7404 | PF8206 | PF8306 | PF8406 |PF8310
PF8410 | PF1550 | PF1555 | PF1565 | PF7706 | PF7710
PF7716 | PF7720 |
Piron Vespucci PF7204 | PF7206 | Pf7210

■ **170 €** + V.A.T.





OS

W A S H I N G

DISHWASHERS

ECO SERIES [106]

UNDERCOUNTER [108]

HOOD-TYPE [117]

UTENSIL [120]

TUNNELS [123]

ACCESSORIES [125]



WH 720 PA

HOOD-TYPE DISHWASHER

DIMENSIONS: 620/703x757x1674/1969 mm

BASKET SIZE: 50x50 cm

USEFUL WASHING HEIGHT: 425 mm - GN 1/1

WASHING ARMS: Top & Bottom

RINSING ARMS: Top & Bottom

OUTPUT: 40-30 baskets/hour

CYCLE: 90" - 120"

WATER CONSUMPTION: 2lt/cycle

TANK / BOILER TEMPERATURE : 55°C / 82°C

TANK / BOILER RESISTANCE : 2.4 kW / 6 kW

WASH PUMP: 550 W

TOTAL POWER / VOLTAGE: 6.550 W | 400 V - 50 Hz

TANK CAPACITY: 20 lt

BOILER CAPACITY: 5 lt

INFO

Included:

Peristaltic electric rinse aid pump with adjustment

1 glass basket

1 plate basket

1 cutlery basket

EXTRA

Water extraction pump 230€ + V.A.T.

Peristaltic electric detergent pump
with adjustment 90€ + V.A.T.

■ **3.930 €** + V.A.T.





WF 400

ANALOG GLASS DISHWASHER

DIMENSIONS: 455x550x700 mm
 BASKET SIZE: 40x40 cm
 USEFUL WASHING HEIGHT: 300 mm
 WASHING ARMS: Bottom
 RINSING ARMS: Top & Bottom
 OUTPUT: 30 baskets/hour
 CYCLE: 120''
 WATER CONSUMPTION: 2 lt/cycle
 TANK / BOILER TEMPERATURE : 55°C / 82°C
 TANK / BOILER RESISTANCE : 2.4 kW / 2.7 kW
 WASH PUMP: 190 W.
 TOTAL POWER / VOLTAGE: 2.890 W / 230 V-50 Hz
 TANK CAPACITY: 12 lt
 BOILER CAPACITY: 3 lt

INFO

Included:
 Peristaltic electric rinse aid pump with adjustment
 1 glass basket
 1 cutlery basket

EXTRA

Water extraction pump 230€ + V.A.T.
 Peristaltic electric detergent pump
 with adjustment 90€ + V.A.T.

■ **1.610 €** + V.A.T.



050001

DISHWASHER BASE WITH BASKET SIZE 40X40cm

AISI 304 stainless steel construction
 Suitable for WF400/AF40/AS40

■ **490 €** + V.A.T.

050002

DISHWASHER BASE WITH BASKET SIZE 50X50cm

AISI 304 stainless steel construction
 Suitable for WF500/AF50/AS50

■ **580 €** + V.A.T.

WF 500 M

ANALOG GLASS/PLATE DISHWASHER

DIMENSIONS: 572x633x814 mm
 BASKET SIZE: 50x50 cm
 USEFUL WASHING HEIGHT: 350 mm - GN 1/1
 WASHING ARMS: Top & Bottom
 RINSING ARMS: Top & Bottom
 OUTPUT: 30 baskets/hour
 CYCLE: 120''
 WATER CONSUMPTION: 2 lt/cycle
 TANK / BOILER TEMPERATURE : 55°C / 82°C
 TANK / BOILER RESISTANCE : 2.4 kW / 2.7 kW
 WASH PUMP: 350 W.
 TOTAL POWER / VOLTAGE: 3.050 W / 230 V-50 Hz
 TANK CAPACITY: 20 lt
 BOILER CAPACITY: 5 lt

INFO

Included:
 Peristaltic electric rinse aid pump with adjustment
 1 glass basket
 1 plate basket
 1 cutlery basket

EXTRA

Water extraction pump 230€ + V.A.T.
 Peristaltic electric detergent pump
 with adjustment 90€ + V.A.T.

■ **2.090 €** + V.A.T.

Dishwashers

AF series  100%
MADE IN
ITALY

UNDERCOUNTER

AF 35.25

ANALOG GLASS DISHWASHER

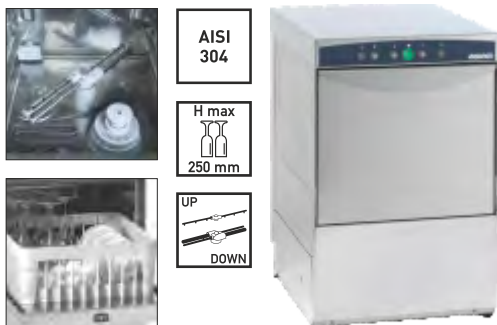

DIMENSIONS: 440x497x640 mm
BASKET SIZE: 35x35 cm
USEFUL WASHING HEIGHT: 250 mm
WASHING ARMS: Bottom
RINSING ARMS: Top & Bottom
OUTPUT: 30 baskets/hour
CYCLE: 120"
WATER CONSUMPTION: 2 lt/cycle
TANK / BOILER TEMPERATURE : 55°C / 82°C
TANK / BOILER RESISTANCE : 2.4 kW / 2.7 kW
WASH PUMP: 190 W.
TOTAL POWER / VOLTAGE: 2.890 W / 230 V-50 Hz
TANK CAPACITY: 10 lt
BOILER CAPACITY: 3 lt

INFO

Included:
Peristaltic electric rinse aid pump with adjustment
2 glass baskets, 1 insert for saucers
1 cutlery basket

EXTRA

Water extraction pump 230€ + V.A.T.
Peristaltic electric detergent pump
with adjustment 90€ + V.A.T.

■ **1.460 €** + V.A.T.

AF 40.30

ANALOG GLASS DISHWASHER

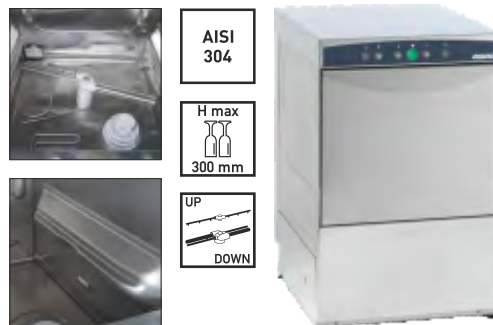

DIMENSIONS: 455x550x700 mm
BASKET SIZE: 40x40 cm
USEFUL WASHING HEIGHT: 300 mm
WASHING ARMS: Bottom
RINSING ARMS: Top & Bottom
OUTPUT: 30 baskets/hour
CYCLE: 120"
WATER CONSUMPTION: 2 lt/cycle
TANK / BOILER TEMPERATURE : 55°C / 82°C
TANK / BOILER RESISTANCE : 2.4 kW / 2.7 kW
WASH PUMP: 190 W.
TOTAL POWER / VOLTAGE: 2.890 W / 230 V-50 Hz
TANK CAPACITY: 12 lt
BOILER CAPACITY: 3 lt

INFO

Included:
Peristaltic electric rinse aid pump with adjustment
2 glass baskets, 1 insert for saucers
1 cutlery basket

EXTRA

Water extraction pump 230€ + V.A.T.
Peristaltic electric detergent pump
with adjustment 90€ + V.A.T.

■ **1.690 €** + V.A.T.

Details that make the difference!

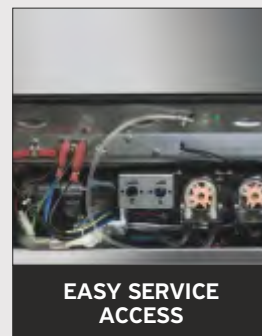
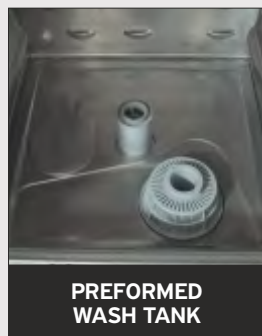

- AISI304 stainless steel construction
- Single skinned body
- Double door insulation

- Peristaltic electric rinse aid pump
- Adjustable tank & boiler thermostat
- Digital Control Panel - LCD screen



AF 40.30 LS

ANALOG PLATE/GLASS DISHWASHER

DIMENSIONS: 455x550x700 mm
 BASKET SIZE: 40x40 cm
 USEFUL WASHING HEIGHT: 300 mm
 WASHING ARMS: Top & Bottom
 RINSING ARMS: Top & Bottom
 OUTPUT: 30 baskets/hour
 CYCLE: 120''
 WATER CONSUMPTION: 2 lt/cycle
 TANK / BOILER TEMPERATURE : 55°C / 82°C
 TANK / BOILER RESISTANCE : 2.4 kW / 2.7 kW
 WASH PUMP: 330 W.
 TOTAL POWER / VOLTAGE: 3.030 W / 230 V-50 Hz
 TANK CAPACITY: 12 lt
 BOILER CAPACITY: 3 lt

INFO

Included:
 Peristaltic electric rinse aid pump with adjustment
 1 glass basket
 1 plate basket
 1 cutlery basket

EXTRA

Water extraction pump 230€ + V.A.T.
 Peristaltic electric detergent pump with adjustment 90€ + V.A.T.

■ **2.160 €** + V.A.T.



AF 45.30

ANALOG PLATE/GLASS DISHWASHER

DIMENSIONS: 503x571x760 mm
 BASKET SIZE: 45x45 cm
 USEFUL WASHING HEIGHT: 300 mm
 WASHING ARMS: Top & Bottom
 RINSING ARMS: Top & Bottom
 OUTPUT: 30 baskets/hour
 CYCLE: 120''
 WATER CONSUMPTION: 2 lt/cycle
 TANK / BOILER TEMPERATURE : 55°C / 82°C
 TANK / BOILER RESISTANCE : 2.4 kW / 2.7 kW
 WASH PUMP: 550 W.
 TOTAL POWER / VOLTAGE: 3.250 W / 230 V-50 Hz
 TANK CAPACITY: 18 lt
 BOILER CAPACITY: 5 lt

INFO

Included:
 Peristaltic electric rinse aid pump with adjustment
 1 glass basket
 1 plate basket
 1 cutlery basket

EXTRA

Water extraction pump 230€ + V.A.T.
 Peristaltic electric detergent pump with adjustment 90€ + V.A.T.

■ **2.360 €** + V.A.T.



Dishwashers

AF series



100%
MADE IN
ITALY

UNDERCOUNTER

AF 50.35 M

ANALOG PLATE/GLASS DISHWASHER

DIMENSIONS: 572x633x814 mm
BASKET SIZE: 50x50 cm
USEFUL WASHING HEIGHT: 350 mm - GN 1/1
WASHING ARMS: Top & Bottom
RINSING ARMS: Top & Bottom
OUTPUT: 40-30 baskets/hour
CYCLE: 90" - 120"
WATER CONSUMPTION: 2 lt/cycle
TANK / BOILER TEMPERATURE : 55°C / 82°C
TANK / BOILER RESISTANCE : 2.4 kW / 2.7 kW
WASH PUMP: 550 W.
TOTAL POWER / VOLTAGE: 3.250 W / 230 V-50 Hz
TANK CAPACITY: 20 lt
BOILER CAPACITY: 5 lt

INFO

Included:
Peristaltic electric rinse aid pump with adjustment
1 glass basket
1 plate basket
1 cutlery basket

EXTRA

Water extraction pump 230€ + V.A.T.
Peristaltic electric detergent pump with adjustment 90€ + V.A.T.
Kit for two baskets simultaneous washing 230€ + V.A.T.

■ **2.290 €** + V.A.T.



AF 50.35 T

ANALOG PLATE/GLASS DISHWASHER

DIMENSIONS: 572x633x814 mm
BASKET SIZE: 50x50 cm
USEFUL WASHING HEIGHT: 350 mm - GN 1/1
WASHING ARMS: Top & Bottom
RINSING ARMS: Top & Bottom
OUTPUT: 40-30 baskets/hour
CYCLE: 90" - 120"
WATER CONSUMPTION: 2 lt/cycle
TANK / BOILER TEMPERATURE : 55°C / 82°C
TANK / BOILER RESISTANCE : 2.4 kW / 4.5 kW
WASH PUMP: 550 W.
TOTAL POWER / VOLTAGE: 5.050 W / **400 V**-50 Hz
TANK CAPACITY: 20 lt
BOILER CAPACITY: 5 lt

INFO

Included:
Peristaltic electric rinse aid pump with adjustment
1 glass basket
1 plate basket
1 cutlery basket

EXTRA

Water extraction pump 230€ + V.A.T.
Peristaltic electric detergent pump with adjustment 90€ + V.A.T.
Kit for two baskets simultaneous washing 230€ + V.A.T.

■ **2.410 €** + V.A.T.



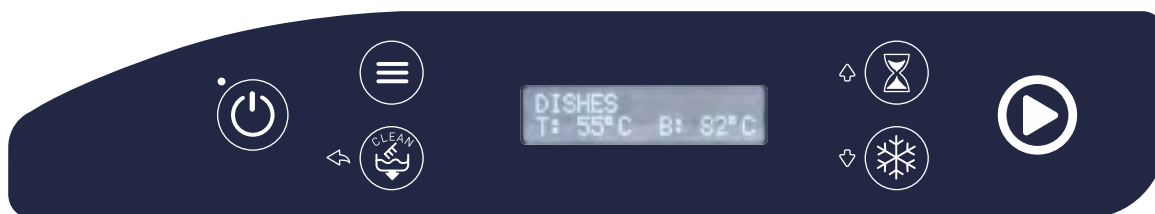

- AISI304 stainless steel construction
- Single skinned body
- Double door insulation
- Peristaltic electric rinse & detergent pumps
- Thermostop system for constant boiler water temperature before rinse starting
- Adjustable tank & boiler thermostat
- Digital Control Panel - LCD screen
- Self-cleaning program
- Green Function - Energy saving
- Soft Start System - Gradual and smooth start of the washing pump
- Self-diagnosis system
- Four washing programs
- PRS system

AISI
304

Ø max
315 mm

H max
290 mm

UP
DOWN



AF 40.30 E LS

DIGITAL PLATE/GLASS DISHWASHER

DIMENSIONS: 455x550x700 mm
 BASKET SIZE: 40x40 cm
 USEFUL WASHING HEIGHT: 300 mm
 WASHING ARMS: Top & Bottom
 RINSING ARMS: Top & Bottom
 OUTPUT: 40-30-20-7 baskets/hour
 CYCLE: 90'' - 120'' - 180'' - 9'
 WATER CONSUMPTION: 2 lt/cycle
 TANK / BOILER TEMPERATURE : 55°C / 82°C
 TANK / BOILER RESISTANCE : 2.4 kW / 2.7 kW
 WASH PUMP: 330 W.
 TOTAL POWER / VOLTAGE: 3.030 W / 230 V-50 Hz
 TANK CAPACITY: 12 lt
 BOILER CAPACITY: 3 lt

INFO

Included:
 Peristaltic electric rinse & detergent pumps with adjustment
 2 glass baskets
 1 insert for saucers
 1 cutlery basket

EXTRA

Water extraction pump 230€ + V.A.T.

PRS VERSION 2.940€ + V.A.T.

■ **2.490 € + V.A.T.**

Dishwashers

AF DIGITAL series



100%
MADE IN
ITALY

UNDERCOUNTER

AF 50.35 E M

DIGITAL PLATE/GLASS DISHWASHER

DIMENSIONS: 572x633x814 mm
BASKET SIZE: 50x50 cm
USEFUL WASHING HEIGHT: 350 mm - GN 1/1
WASHING ARMS: Top & Bottom
RINSING ARMS: Top & Bottom
OUTPUT: 40-30-20-7 baskets/hour
CYCLE: 90" - 120" - 180" - 9'
WATER CONSUMPTION: 2 lt/cycle
TANK / BOILER TEMPERATURE : 55°C / 82°C
TANK / BOILER RESISTANCE : 2.4 kW / 2.7 kW
WASH PUMP: 550 W.
TOTAL POWER / VOLTAGE: 3.250 W / 230 V-50 Hz
TANK CAPACITY / BOILER: 20 lt / 5 lt

INFO

Included:
Peristaltic electric rinse & detergent pumps with adjustment
1 glass basket
1 plate basket
1 cutlery basket

EXTRA

Water extraction pump 230€ + V.A.T.
Kit for two baskets simultaneous washing 230€ + Φ.Π.A.

PRS VERSION 3.450€ + Φ.Π.A

■ **2.940€ + V.A.T.**



AF 50.35 E T

DIGITAL PLATE/GLASS DISHWASHER

DIMENSIONS: 572x633x814 mm
BASKET SIZE: 50x50 cm
USEFUL WASHING HEIGHT: 350 mm - GN 1/1
WASHING ARMS: Top & Bottom
RINSING ARMS: Top & Bottom
OUTPUT: 40-30-20-7 baskets/hour
CYCLE: 90" - 120" - 180" - 9'
WATER CONSUMPTION: 2 lt/cycle
TANK / BOILER TEMPERATURE : 55°C / 82°C
TANK / BOILER RESISTANCE : 2.4 kW / 4.5 kW
WASH PUMP: 550 W.
TOTAL POWER / VOLTAGE: 5.050 W / **400 V**-50 Hz
TANK CAPACITY / BOILER: 20 lt / 5 lt

INFO

Included:
Peristaltic electric rinse & detergent pumps with adjustment
1 glass basket
1 plate basket
1 cutlery basket

EXTRA

Water extraction pump 230€ + V.A.T.
Kit for two baskets simultaneous washing 230€ + Φ.Π.A.

PRS VERSION 3.580€ + Φ.Π.A

■ **3.130€ + V.A.T.**



PRS (Premium Rinse System)

PRS system enables to oversee every detail of the rinse cycle given the combination of the break tank, the atmospheric boiler and the rinse pump. PRS system guarantees constant temperature throughout the entire rinse cycle, avoiding mixing with cold water, as well as constant output pressure from rinse nozzle and excellent roatation of the rinsing arms. What are the benefits of PRS system?

- Best sanitisation
- Complete detergent removal
- Fast drying
- Optimum consumption of water and chemical products

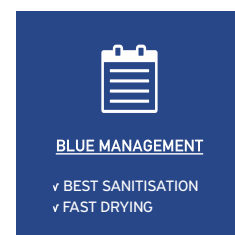
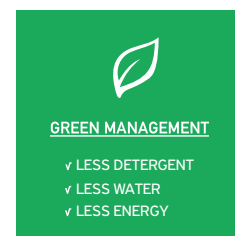
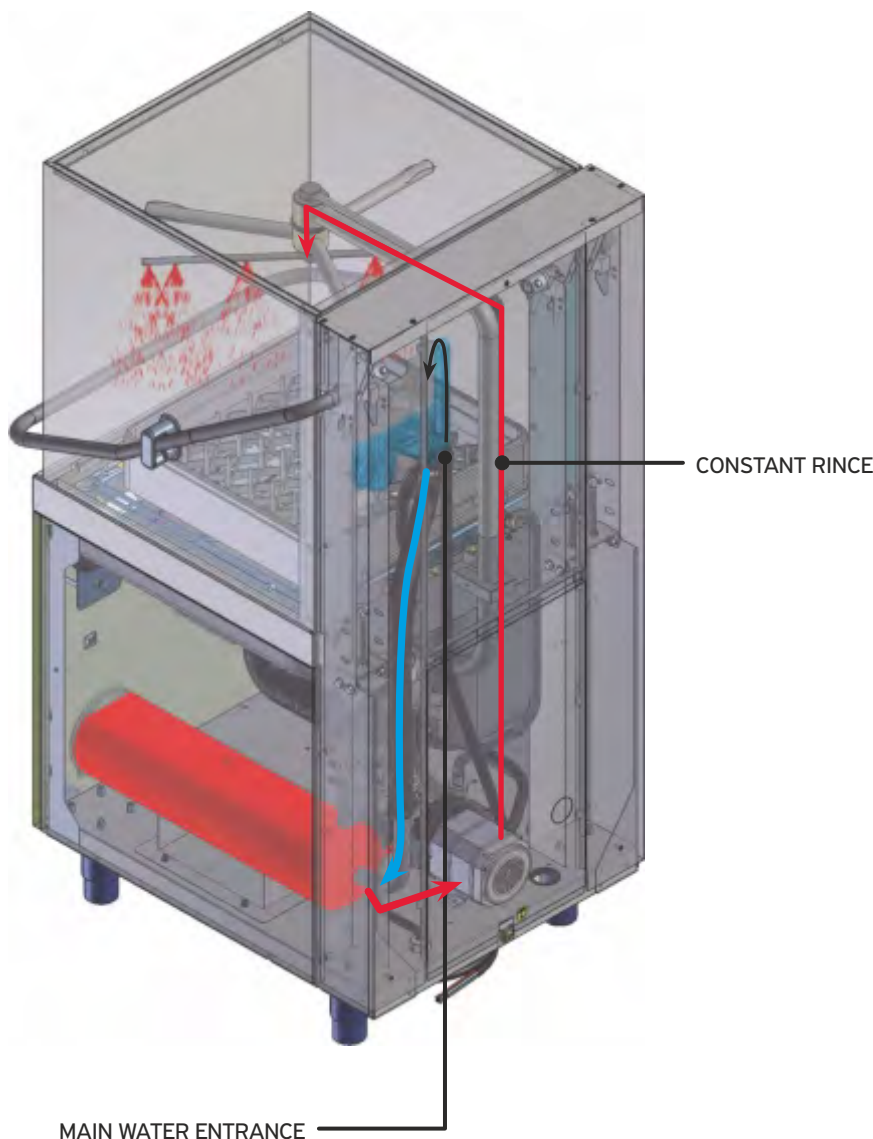

Dishwashers

UNDERCOUNTER

σειρά AS DIGITAL



100%
MADE IN
ITALY

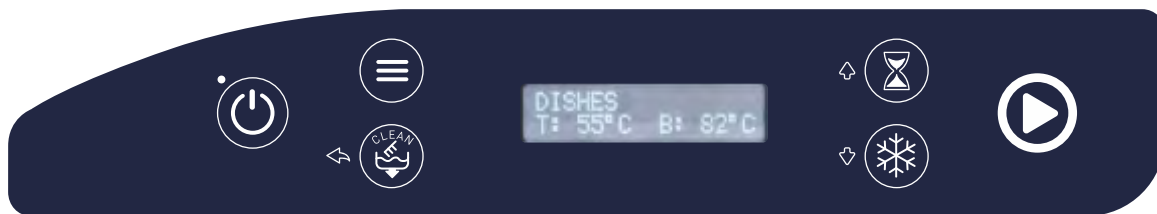

- AISI304 stainless steel construction
- Double skinned body
- Double door insulation
- Peristaltic electric rinse & detergent pumps
- Thermostop system for constant boiler water temperature before rinse starting
- Adjustable tank & boiler thermostat
- Digital Control Panel - LCD screen
- Self-cleaning program
- Green Function - Energy saving
- Soft Start System - Gradual and smooth start of the washing pump
- Self-diagnosis system
- Four washing programs
- PRS system
- SD system

AS 40.30 E PRS SD

DIGITAL PLATE/GLASS DISHWASHER

DIMENSIONS: 483x550x700 mm
BASKET SIZE: 40x40 cm
USEFUL WASHING HEIGHT: 290 mm
WASHING ARMS: Top & Bottom
RINSING ARMS: Top & Bottom
OUTPUT: 40-30-20-7 baskets/hour
CYCLE: 90'' - 120'' - 180'' - 9'
WATER CONSUMPTION: 2 lt/cycle
TANK / BOILER TEMPERATURE : 55°C / 82°C
TANK / BOILER RESISTANCE : 2.4 kW / 2.7 kW
WASH PUMP: 330 W.
TOTAL POWER / VOLTAGE: 3.030 W / 230 V-50 Hz
TANK CAPACITY: 12 lt
BOILER CAPACITY: 3 lt

INFO

Included:
Peristaltic electric rinse & detergent pump with adjustment
2 glass baskets
1 insert for saucers
1 cutlery basket

■ **3.590 €** + V.A.T.

PRS
system

SD
system



AISI
304

AISI
316
BOILER

Ø max
315 mm

H max
290 mm

UP
DOWN

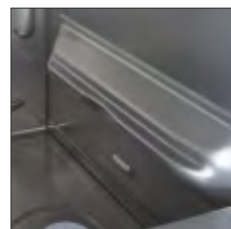

PRS
system

SD
system



AISI
304

AISI
316
BOILER

Ø max
315 mm

H max
290 mm

UP
DOWN



AS 50.35 E PRS SD

DIGITAL PLATE/GLASS DISHWASHER

DIMENSIONS: 600x633x814 mm
BASKET SIZE: 50x50 cm
USEFUL WASHING HEIGHT: 340 mm - GN 1/1
WASHING ARMS: Top & Bottom
RINSING ARMS: Top & Bottom
OUTPUT: 40-30-20-7 baskets/hour
CYCLE: 90'' - 120'' - 180'' - 9'
WATER CONSUMPTION: 2 lt/cycle
TANK / BOILER TEMPERATURE : 55°C / 82°C
TANK / BOILER RESISTANCE : 2.4 kW / 6 kW
WASH PUMP: 550 W.
TOTAL POWER / VOLTAGE: 6.550 W / 400 V-50 Hz
TANK CAPACITY: 20 lt
BOILER CAPACITY: 5.5 lt

INFO

Included:
Peristaltic electric rinse & detergent pumps with adjustment
1 glass basket
1 plate basket
1 cutlery basket

EXTRA

Kit for two baskets simultaneous washing 230€ + V.A.T.

■ **4.390 €** + V.A.T.

PRS
system

SD
system



AISI
304

AISI
316
BOILER

Ø max
315 mm

H max
290 mm

UP
DOWN



AS 60.40 E PRS SD

DIGITAL PLATE/GLASS DISHWASHER

DIMENSIONS: 600x703x850 mm
BASKET SIZE: 50x60 cm
USEFUL WASHING HEIGHT: 380mm - Tray 60x40 cm
WASHING ARMS: Top & Bottom
RINSING ARMS: Top & Bottom
OUTPUT: 40-30-20-7 baskets/hour
CYCLE: 90'' - 120'' - 180'' - 9'
WATER CONSUMPTION: 2 lt/cycle
TANK / BOILER TEMPERATURE : 55°C / 82°C
TANK / BOILER RESISTANCE : 2.4 kW / 6 kW
WASH PUMP: 680 W.
TOTAL POWER / VOLTAGE: 6.680 W / 230 V - 50 Hz
TANK CAPACITY: 22 lt
BOILER CAPACITY: 5.5 lt

INFO

Included:
Peristaltic electric rinse & detergent pumps with adjustment
1 glass basket
1 plate basket
1 cutlery basket

■ **4.590 €** + V.A.T.

Dishwashers



SD (Smart Drain System) Clean water function

SD system maintains the water tank level without using the overflow pipe, but employing an automatically actioned and electronically driven drain pump. Prior to starting to rinse with clean water, the SD system partially empties the water present in tank by draining the dirtiest water from the bottom & not from the top, as it used to be with the overflow pipe. This way all the clean water introduced during rinsing phase «regenerates» the tank water, increasing water quality. SD system is only available with PRS system. What are the benefits of SD system?

- Improved washing performance in continuous & intensive use.
- Reduction of detergent consumption.
- Energy & water saving.

STANDARD SYSTEM

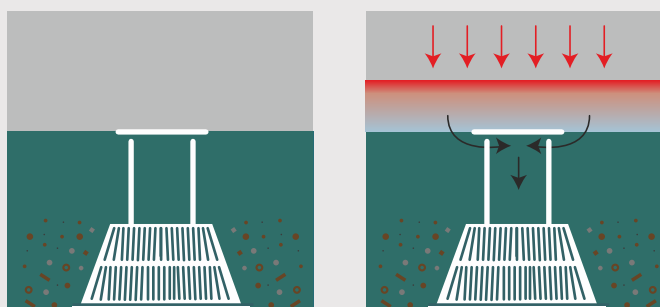

SMART DRAIN SYSTEM

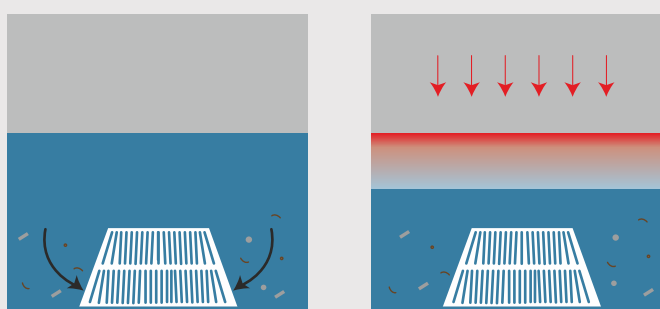

Dishwashers

AH series

ALSTARCO
made for washing

HOOD-TYPE

MP
tech

AISI
304

Ø max
450 mm

H max
425 mm

GN 1/1
530x325

LT 80

UP
DOWN



AH 800

HOOD-TYPE ANALOG DISHWASHER

DIMENSIONS: 657/760x793x1494/1969 mm

BASKET SIZE: 50x50 cm

USEFUL WASHING HEIGHT: 425 mm - GN 1/1

WASHING ARMS: Top & Bottom

RINSING ARMS: Top & Bottom

OUTPUT: 40-30 baskets/hour

CYCLE: 90" - 120"

WATER CONSUMPTION: 2.5 lt/cycle

TANK / BOILER TEMPERATURE : 55°C / 82°C

TANK / BOILER RESISTANCE : 2.8 kW / 6 kW

WASH PUMP: 750 W.

TOTAL POWER / VOLTAGE: 6.750 W / 400 V-50 Hz

TANK CAPACITY: 30 lt

BOILER CAPACITY: 8 lt

INFO

Included:

Peristaltic electric rinse aid pump with adjustment

1 glass basket

2 plate baskets

2 cutlery baskets

EXTRA

Water extraction pump 230€ + V.A.T.

Peristaltic electric detergent pump

with adjustment 90€ + V.A.T.

■ **4.380 €** + V.A.T.

Details that make the difference!



STAINLESS STEEL
WASH & RINSE ARMS

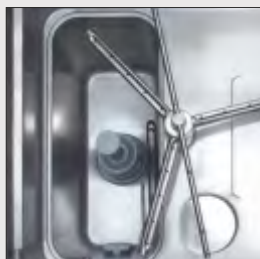

PREFORMED
WASH TANK



VERTICAL
PUMP



EASY SERVICE
ACCESS

- AISI304 stainless steel construction
- Double door insulation
- Peristaltic electric rinse aid pump

PLUS DIGITAL VERSION

- Self-cleaning program
- Green Function - Energy saving
- Soft Start System - Gradual and smooth start of the washing pump
- Self-diagnosis system

- Adjustable tank & boiler thermostat
- Energy saving insulated boiler
- Digital Control Panel - LCD screen

- Four washing programs
- Thermostop system for constant boiler water temperature before rinse starting
- PRS system
- SD system

Dishwashers

AH DIGITAL series



100%
MADE IN
ITALY

HOOD-TYPE

AH 800 E

HOOD-TYPE DIGITAL DISHWASHER

DIMENSIONS: 657/760x793x1494/1969 mm
BASKET SIZE: 50x50 cm
USEFUL WASHING HEIGHT: 425 mm - GN 1/1
WASHING ARMS: Top & Bottom
RINSING ARMS: Top & Bottom
OUTPUT: 60-30-20-7 baskets/hour
CYCLE: 60" - 120" - 180" - 9'
WATER CONSUMPTION: 2.5 lt/cycle
TANK / BOILER TEMPERATURE : 55°C / 82°C
TANK / BOILER RESISTANCE : 2.8 kW / 6 kW
WASH PUMP: 750 W.
TOTAL POWER / VOLTAGE: 6.750 W / 400 V-50 Hz
TANK CAPACITY: 30 lt
BOILER CAPACITY: 8 lt

INFO

Included:
Peristaltic electric rinse & detergent pumps with adjustment
1 glass basket
2 plate baskets
2 cutlery baskets

EXTRA

Water extraction pump 230€ + V.A.T.

PRS VERSION 5.550€ + V.A.T.

ES VERSION 8.800€ + V.A.T.

■ **5.150 €** + V.A.T.



AH 60.42 E

HOOD-TYPE DIGITAL DISHWASHER

DIMENSIONS: 657/785x793x1494/1969 mm
BASKET SIZE: 50x60 cm
USEFUL WASHING HEIGHT: 415 mm (Suitable for tray 40x60cm)
WASHING ARMS: Top & Bottom
RINSING ARMS: Top & Bottom
OUTPUT: 60-30-20-7 baskets/hour
CYCLE: 60" - 120" - 180" - 9'
WATER CONSUMPTION: 2.5 lt/cycle
TANK / BOILER TEMPERATURE : 55°C / 82°C
TANK / BOILER RESISTANCE : 4.5 kW / 9 kW
WASH PUMP: 1.300 W.
TOTAL POWER / VOLTAGE: 10.300 W / 400 V-50 Hz
TANK CAPACITY: 40 lt
BOILER CAPACITY: 8 lt

INFO

Double-skinned insulated body
Included:
Peristaltic electric rinse & detergent pumps with adjustment
1 glass basket, 2 plate baskets
2 cutlery baskets

EXTRA

Water extraction pump 230€ + V.A.T.

PRS VERSION 7.850€ + V.A.T.

ES VERSION 10.450€ + V.A.T.

■ **7.450 €** + V.A.T.



ES (Energy Saving System)

In ES system a tangential fan recycles the hot steam generated during the wash and rinse phases, making it pass through a highly efficient heat exchanger, with cold water circulating inside, provided by the water supply. The cold water supplied is introduced into the boiler at a temperature of approximately 45°C and the steam produced is used to heat the cold water (energy saving). We also avoid annoying emissions of steam with detergent in the work area, without using an external steam absorption system. ES system is only available with PRS system. What are the benefits of ES system?

- Energy & water saving.
- No need for external ventilation system.
- No steam in working area.

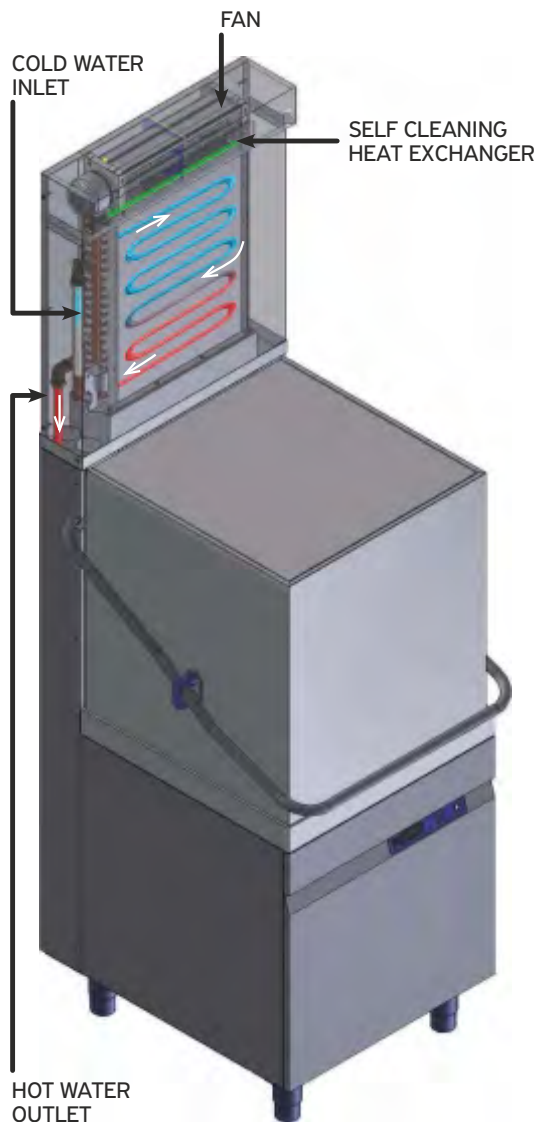

Dishwashers

AU series



100%
MADE IN
ITALY

UTENSIL



The smallest
undercounter
utensil dishwasher!



AU 60.40 E

DIGITAL UTENSIL DISHWASHER

DIMENSIONS: 600x703x850 mm
BASKET SIZE: 50x60 cm
USEFUL WASHING HEIGHT: 400 mm - tray 40x60 cm
WASHING ARMS: Top & Bottom
RINSING ARMS: Top & Bottom
OUTPUT: 30-15-10-7 baskets/hour
CYCLE: 2' - 4' - 6' - 9'
WATER CONSUMPTION: 2 lt/cycle
TANK / BOILER TEMPERATURE : 55°C / 82°C
TANK / BOILER RESISTANCE : 2.4 kW / 4.5 kW
WASH PUMP: 680 W.
TOTAL POWER / VOLTAGE: 6.750 W / 400 V-50 Hz
TANK CAPACITY: 22 lt
BOILER CAPACITY: 5 lt

INFO

Double-skinned insulated body
Included:
Peristaltic electric rinse & detergent pumps with adjustment
1 utensil basket
1 stainless steel rack for 4 trays 40x60 cm

EXTRA

Water extraction pump 230€ + V.A.T.

PRS SD VERSION 5.450€ + V.A.T.

4.600 € + V.A.T.

Details that make the difference!

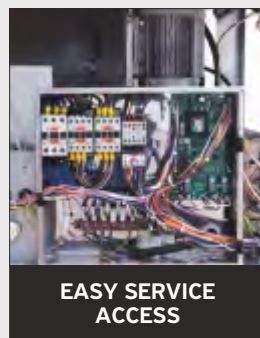
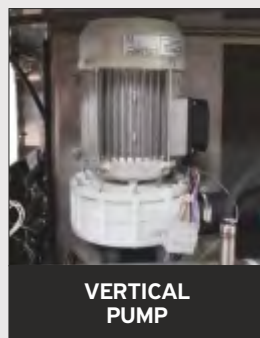

- AISI304 stainless steel construction
- Double door insulation
- Adjustable tank & boiler thermostat
- Energy saving insulated boiler

- Tank & boiler AISI316 stainless steel constructed
- Analog or digital Control Panel - LCD screen

PLUS DIGITAL VERSION

- Self-cleaning program
- Green Function - Energy saving
- Soft Start System - Gradual and smooth start of the washing pump
- Self-diagnosis system

- Four washing programs
- Thermostop system for constant boiler water temperature before rinse starting
- PRS system
- SD system



AU 55.65 EASY PRS

ANALOG UTENSIL DISHWASHER

DIMENSIONS: 706x883x1829/1997 mm
 BASKET SIZE: 56.5x69 cm
 USEFUL WASHING HEIGHT:
 650 mm - tray 40x60 cm
 WASHING ARMS: Top & Bottom
 RINSING ARMS: Top & Bottom
 OUTPUT: 20-10-7 baskets/hour
 CYCLE: 3' - 6' - 9'
 WATER CONSUMPTION: 3 lt/cycle
 TANK / BOILER TEMPERATURE : 55°C / 82°C
 TANK / BOILER RESISTANCE : 2.8 kW / 6 kW
 WASH PUMP: 1.300 W.
 TOTAL POWER / VOLTAGE: 7.300 W / 400 V-50 Hz
 TANK CAPACITY: 50 lt
 BOILER CAPACITY: 11 lt

INFO

PRS system
 Included:
 1 utensil basket

EXTRA

Water extraction pump 450€ + V.A.T.
 Peristaltic electric detergent pump 200€ + V.A.T.
 Peristaltic electric rinse aid pump 200€ + V.A.T.

■ **8.700 €** + V.A.T.



AU 65.65 PRS

ANALOG UTENSIL DISHWASHER

DIMENSIONS: 835x1023x1883/2111 mm
 BASKET SIZE: 66x81.5 cm
 USEFUL WASHING HEIGHT:
 650 mm - tray 60x80 cm
 WASHING ARMS: Top & Bottom
 RINSING ARMS: Top & Bottom
 OUTPUT: 20-10-7 baskets/hour
 CYCLE: 3' - 6' - 9'
 WATER CONSUMPTION: 3.5 lt/cycle
 TANK / BOILER TEMPERATURE : 55°C / 82°C
 TANK / BOILER RESISTANCE : 6 kW / 6 kW
 WASH PUMP: 2.300 W.
 TOTAL POWER / VOLTAGE: 8.300 W / 400 V-50 Hz
 TANK CAPACITY: 65 lt
 BOILER CAPACITY: 11 lt

INFO

Double-skinned insulated body
 PRS system
 Included:
 1 utensil basket

EXTRA

Water extraction pump 450€ + V.A.T.
 Peristaltic electric detergent pump 200€ + V.A.T.
 Peristaltic electric rinse aid pump 200€ + V.A.T.

■ **15.250 €** + V.A.T.

Dishwashers

AU series  100%
MADE IN ITALY

UTENSIL

AU 55.80 PRS

ANALOG UTENSIL DISHWASHER

DIMENSIONS: 740x876x2034/2330 mm
BASKET SIZE: 56.5x69 cm
USEFUL WASHING HEIGHT:
800 mm - tray 60x80 cm
WASHING ARMS: Top & Bottom
RINSING ARMS: Top & Bottom
OUTPUT: 20-10-7 baskets/hour
CYCLE: 3' - 6' - 9'
WATER CONSUMPTION: 3.5 lt/cycle
TANK / BOILER TEMPERATURE : 55°C / 82°C
TANK / BOILER RESISTANCE : 6 kW / 6 kW
WASH PUMP: 2.300 W.
TOTAL POWER / VOLTAGE: 8.300 W / 400 V-50 Hz
TANK CAPACITY: 65 lt
BOILER CAPACITY: 11 lt

INFO

Double-skinned insulated body
PRS system
Included:
1 utensil basket

EXTRA

Water extraction pump 450€ + V.A.T.
Peristaltic electric detergent pump 200€ + V.A.T.
Peristaltic electric rinse aid pump 200€ + V.A.T.

■ **15.250 €** + V.A.T.



AU 125.80 PRS

ANALOG UTENSIL DISHWASHER

DIMENSIONS: 1436x995x2034/2330 mm
BASKET SIZE: 126x81.5 cm
USEFUL WASHING HEIGHT:
800 mm - tray 60x80 cm
WASHING ARMS: Top & Bottom
RINSING ARMS: Top & Bottom
OUTPUT: 20-10-7 baskets/hour
CYCLE: 3' - 6' - 9'
WATER CONSUMPTION: 7 lt/cycle
TANK / BOILER TEMPERATURE : 55°C / 82°C
TANK / BOILER RESISTANCE : 9 kW / 9 kW
WASH PUMP: 2.300 W.
TOTAL POWER / VOLTAGE: 15.000 W / 400 V-50 Hz
TANK CAPACITY: 100 lt
BOILER CAPACITY: 17 lt

INFO

Double-skinned insulated body
PRS system
Included:
1 utensil basket

EXTRA

Water extraction pump 450€ + V.A.T.
Peristaltic electric detergent pump 200€ + V.A.T.
Peristaltic electric rinse aid pump 200€ + V.A.T.

■ **24.090 €** + V.A.T.



Dishwashers

AR series



TUNNEL

Details that make the difference!

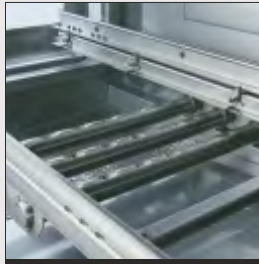

**STAINLESS STEEL
WASH & RINSE ARMS**



**BOILER INSULATION
INOX AISI316**



**VERTICAL
PUMP**



**EASY SERVICE
ACCESS**

- AISI304 stainless steel construction
- Double door insulation
- Adjustable tank & boiler thermostat
- Energy saving insulated boiler
- Tank & boiler AISI316 stainless steel constructed
- Analog or digital Control Panel - LCD screen



	AR 1200	AR 1650	AR 2000	AR 2500
DIMENSIONS	1150x770x1710/2110 mm	1550x770x1710/2110 mm	1800x770x1710/2110 mm	1800x770x1710/2110 mm
USEFUL WASHING HEIGHT	470 mm - GN 1/1	470 mm - GN 1/1	470 mm - GN 1/1	470 mm - GN 1/1
WASH PUMP	0.9 kw	2 kw	2 kw	2.35 kw
WATER CONSUMPTION	150 lt/h	165 lt/h	225 lt/h	240 lt/h
RESISTANCE TANK	9 kw	9 kw	12 kw	12 kw
RESISTANCE BOILER	9 kw	9 kw	12 kw	15 kw
TANK CAPACITY	65 lt	105 lt	105 lt	105 lt
BOILER CAPACITY	9 lt	9 lt	9 lt	2x9 lt
CYCLE	Washing - Rinsing	Washing - Rinsing	Washing - Rinsing	Washing - Rinsing
PROGRAMMES	3 Light/Standard/DIN10510	3 Light/Standard/DIN10510	3 Light/Standard/DIN10510	3 Light/Standard/DIN10510
BASKETS/HOUR	100/90/70	110/100/90	150/120/93	160/140/93
	ARR2500	AR 3000	ARR 3500	ARR 4000
DIMENSIONS	2000x770x1710/2110 mm	2400x770x1710/2110 mm	2600x770x1710/2110 mm	2600x770x1710/2110 mm
USEFUL WASHING HEIGHT	470 mm - GN 1/1	470 mm - GN 1/1	470 mm - GN 1/1	470 mm - GN 1/1
WASH PUMP	2.35 kw	2.35 kw	2.35 kw	2.35 kw
WATER CONSUMPTION	240 lt/h	345 lt/h	325 lt/h	351 lt/h
RESISTANCE TANK	12 kw	12 kw	12 kw	12 kw
RESISTANCE BOILER	15 kw	18 kw	18 kw	21 kw
TANK CAPACITY	105 lt	105 lt	105 lt	105 lt
BOILER CAPACITY	2x9 lt	2x9 lt	2x9 lt	2x9 lt
CYCLE	Washing - Double rinsing	Washing - Rinsing	Prewashing - Washing - Double rinsing	Double washing - Double rinsing
PROGRAMMES	3 Light/Standard/DIN10510	3 Light/Standard/DIN10510	3 Light/Standard/DIN10510	3 Light/Standard/DIN10510
BASKETS/HOUR	170/150/105	230/200/145	250/220/145	270/250/145

*For further information contact our sales department.

Dishwashers

AFX series  100%
MADE IN
ITALY

TUNNEL WITH BELT

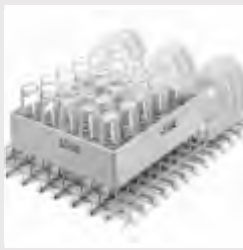

	AFX 3500	AFX 4000	AFX 6000	AFX 8000
DIMENSIONS	4500x985x1860/2200mm	5100x985x1860/2200 mm	6000x985x1860/2200 mm	7300x985x1860/2200 mm
USEFUL WASHING HEIGHT	710x450 mm	710x450 mm	710x450 mm	710x450 mm
WASH PUMP	2kw	2 kw	2 kw	2 kw
WATER CONSUMPTION	190 lt/h	230 lt/h	386 lt/h	504 lt/h
RESISTANCE TANK	14 kw	14 kw	14 kw	12 kw
RESISTANCE BOILER	10.5 kw	12 kw	18 kw	24 kw
TANK CAPACITY	100 lt	100 lt	100 lt	100 lt
BOILER CAPACITY	2x10 lt	2x10 lt	2x10 lt	2x10 lt
CYCLE	Washing - Double rinsing	Washing - Rinsing	Double washing - Double rinsing	Prewashing - Double washing - Double rinsing
PROGRAMMES	5 Max / DIN10510	5 Max / DIN10510	5 Max / DIN10510	5 Max / DIN10510
BASKETS/HOUR	3.675 / 1950	4.050 / 2.400	6.450 / 4.200	8.100 / 5.250

*For further information contact our sales department.

Accessories

BASKETS & RACKS



2462
GLASS BASKET
350x350x150 mm

■ **17 €** + V.A.T.



630 S
GLASS BASKET
380x380x150 mm

■ **18,50 €** + V.A.T.



2146
GLASS BASKET
400x400x150 mm

■ **19 €** + V.A.T.



2150
PLATES BASKET
400x400x110 mm

■ **26 €** + V.A.T.



2491
GLASS RACK
450x450x165 mm

■ **26 €** + V.A.T.



2492
PLATES RACK
450x450x106 mm

■ **28 €** + V.A.T.



2493
CUTLERY RACK
450x450x106 mm

■ **26 €** + V.A.T.



240 N
GLASS RACK
500x500x106 mm

■ **22 €** + V.A.T.



239
CUTLERY RACK
500x500x106 mm

■ **26 €** + V.A.T.



237 N
PLATES RACK
500x500x106 mm

■ **24 €** + V.A.T.



238
TRAYS RACK
500x500x106 mm

■ **31 €** + V.A.T.



5780
ROUND GLASS BASKET
Z 350x160 (h) mm

■ **24 €** + V.A.T.



5782
ROUND GLASS BASKET
Z 380x170 (h) mm

■ **25 €** + V.A.T.



5781
ROUND GLASS BASKET
Z 400x180 (h) mm

■ **27,50 €** + V.A.T.

Accessories

DIVIDERS & EXTENDERS



1878
EXTENDER
500x500x30 mm

■ 11 € + V.A.T.



1879
EXTENDER
(GLASS DIVIDER OPTION)
500x500x50 mm

■ 11 € + V.A.T.



6661
BASKET COVER
500x500x25 mm

■ 25 € + V.A.T.

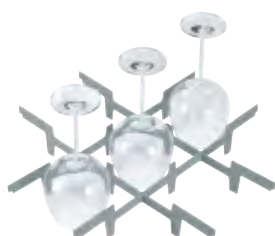

GLASS SEPARATOR
Suitable for
glass basket 50x50 cm

- 1884** 9 glasses Z 150mm
- 1880** 16 glasses Z 110mm
- 1881** 25 glasses Z 89mm
- 1882** 36 glasses Z 73mm
- 1883** 49 glasses Z 62mm

■ 11 € + V.A.T.



EXTENDER
WITH INCORPORATED GLASS DIVIDER
Suitable for
glass basket 50x50 cm

- 1009** 9 glasses Z 150mm
- 1016** 16 glasses Z 110mm
- 1025** 25 glasses Z 89mm
- 1035** 36 glasses Z 73mm
- 1049** 49 glasses Z 62mm

■ 15 € + V.A.T.



6642
SQUARE BASKET
FOR CUTLERY
113x113x89 mm

■ 3 € + V.A.T.



6643
8 COMPARTMENT
CUTLERY BASKET
485x230x146 mm

■ 22 € + V.A.T.



1877
TILTING CLIP
FOR GLASSES
Suitable for
glass basket 40x40 cm

■ 8 € + V.A.T.



187
12 SAUCERS'
RACK
290x90x75 mm

■ 8 € + V.A.T.

COMPONENTS



8395-0025
CONNECTION KIT
FOR TWO BASKETS
50x50 cm

■ **230 €** + V.A.T.

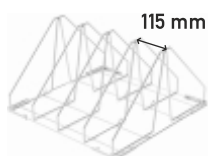

8080-0023
BASE FOR 4 GN
STAINLESS STEEL
500x500x170 mm

■ **230 €** + V.A.T.

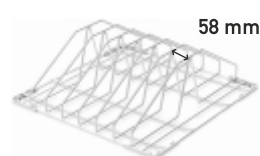

8380-0009
BASE FOR 6 GN
STAINLESS STEEL
500x500x170 mm

■ **230 €** + V.A.T.



1368
FILTER UNIT 16LT

■ **2 €** + V.A.T.



KIT 01
INSTALLATION KIT
FOR RINSE
AID PUMP

■ **14 €** + V.A.T.



PS
DRAIN PUMP
FACTORY
INSTALLED

■ **230 €** + V.A.T.



B04 REG
RINSE AID PUMP
WITH ADJUSTMENT
ELECTRIC
PERISTALTIC

■ **90 €** + V.A.T.



D3 REG
DETERGENT PUMP
WITH ADJUSTMENT
ELECTRIC
PERISTALTIC

■ **90 €** + V.A.T.



5075
DETERGENT INJECTOR
FEED-THROUGH
STAINLESS STEEL

■ **11 €** + V.A.T.



4120
3 WAYS DISTRIBUTOR

■ **2,50 €** + V.A.T.



2503
PRESSURE ATTACK

■ **6,50 €** + V.A.T.



1000
RINSE AID
INNER TUBE

■ **14 €** + V.A.T.



2000
DETERGENT
INNER TUBE

■ **14 €** + V.A.T.



61
RUBBER HOSE
TRANSPARENT

■ **1,50 €** + V.A.T.



610
RUBBER HOSE
BLUE

■ **1,50 €** + V.A.T.



IS

I C E M A K E R S

ICEMAKERS

ICEMAKERS ARISTARCO

- FULL ICE CUBE [130]
- HOLLOW ICE CUBE [137]
- GRANULAR ICE [139]
- FLAT ICE FLAKE [141]
- STORAGE BINS [142]

ICEMAKERS PLUM

- HOLLOW ICE CUBE [144]
- DICE ICE CUBE [145]
- STORAGE BINS [147]

Icemakers

FULL ICE CUBE

series CP **ALSTARCO**
ICE PLEASE!

CP 20.6

FULL ICE CUBE ICEMAKER

DIMENSIONS: 365x495x600 mm
FEET: + (0-20 mm)
OUTPUT: 20 kg (≈ 1111 ice cubes) / 24h
STORAGE CAPACITY: 6 kg
POWER / VOLTAGE: 450 W / 230V/50Hz
REFRIGERANT: R452a
COOLING SYSTEM: Air cooled / Water cooled

INFO

Ice cubes/cycle: 24
Type: Solid ice cube 18gr

EXTRA

Air filter 90€+V.A.T.

■ **1.320 €** + V.A.T.



Reduced water consumption



Energy efficiency

Reduced maintenance costs



100% made in Italy

CP 25.6

FULL ICE CUBE ICEMAKER

DIMENSIONS: 365x495x600 mm
FEET: + (0-20 mm)
OUTPUT: 25 kg (≈ 1388 ice cubes) / 24h
STORAGE CAPACITY: 6 kg
POWER / VOLTAGE: 450 W / 230V/50Hz
REFRIGERANT: R452a
COOLING SYSTEM: Air cooled / Water cooled

INFO

Ice cubes/cycle: 28
Type: Solid ice cube 18gr

EXTRA

Air filter 90€+V.A.T.

■ **1.540 €** + V.A.T.

CP 30.10

FULL ICE CUBE ICEMAKER

DIMENSIONS: 365x495x690 mm
FEET: + (0-20 mm)
OUTPUT: 30 kg (≈ 1666 ice cubes) / 24h
STORAGE CAPACITY: 10 kg
POWER / VOLTAGE: 450 W / 230V/50Hz
REFRIGERANT: R452a
COOLING SYSTEM: Air cooled / Water cooled

INFO

Ice cubes/cycle: 28
Type: Solid ice cube 18gr

EXTRA

Air filter 90€+V.A.T.

■ **1.650 €** + V.A.T.



Solid Ice Cube
18gr

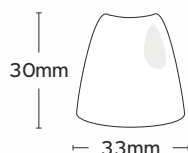

- High density, pure, crystal clear solid ice cubes
- Made entirely of stainless steel
- Maximum efficiency
- Latest technology
- Compressor Tropical
- Attractive and ergonomic design



Daily production is estimated at 21°C room temperature and 15°C water temperature

CP 40.15

FULL ICE CUBE ICEMAKER

DIMENSIONS: 500x585x685 mm
FEET: + (0-20 mm)
OUTPUT: 40 kg (≈ 2222 ice cubes) / 24h
STORAGE CAPACITY: 15 kg
POWER / VOLTAGE: 570 W / 230V/50Hz
REFRIGERANT: R452a
COOLING SYSTEM: Air cooled / Water cooled

INFO

Ice cubes/cycle: 40
Type: Solid ice cube 18gr

EXTRA

Air filter 90€+V.A.T.

■ **1.760 €** + V.A.T.

CP 50.25

FULL ICE CUBE ICEMAKER

DIMENSIONS: 500x585x795 mm
FEET: + (0-20 mm)
OUTPUT: 50 kg (≈ 2778 ice cubes) / 24h
STORAGE CAPACITY: 25 kg
POWER / VOLTAGE: 750 W / 230V/50Hz
REFRIGERANT: R452a
COOLING SYSTEM: Air cooled / Water cooled

INFO

Ice cubes/cycle: 64
Type: Solid ice cube 18gr

EXTRA

Air filter 90€+V.A.T.

■ **2.150 €** + V.A.T.



CP 45.15

FULL ICE CUBE ICEMAKER

DIMENSIONS: 500x585x685 mm
FEET: + (0-20 mm)
OUTPUT: 45 kg (≈ 2500 ice cubes) / 24h
STORAGE CAPACITY: 15 kg
POWER / VOLTAGE: 6000 W / 230V/50Hz
REFRIGERANT: R452a
COOLING SYSTEM: Air cooled / Water cooled

INFO

Ice cubes/cycle: 40
Type: Solid ice cube 18gr

EXTRA

Air filter 90€+V.A.T.

■ **2.050 €** + V.A.T.

CP 60.40

FULL ICE CUBE ICEMAKER

DIMENSIONS: 740x605x915 mm
FEET: + (40-50 mm)
OUTPUT: 60 kg (≈ 3333 ice cubes) / 24h
STORAGE CAPACITY: 40 kg
POWER / VOLTAGE: 780 W / 230V/50Hz
REFRIGERANT: R452a
COOLING SYSTEM: Air cooled / Water cooled

INFO

Ice cubes/cycle: 64
Type: Solid ice cube 18gr

EXTRA

Air filter 90€+V.A.T.

■ **2.850 €** + V.A.T.

CP 85.40

FULL ICE CUBE ICEMAKER

DIMENSIONS: 740x605x915 mm
FEET: + (40-50 mm)
OUTPUT: 85 kg (≈ 4722 ice cubes) / 24h
STORAGE CAPACITY: 40 kg
POWER / VOLTAGE: 1050 W / 230V/50Hz
REFRIGERANT: R452a
COOLING SYSTEM: Air cooled / Water cooled

INFO

Ice cubes/cycle: 64
Type: Solid ice cube 18gr

EXTRA

Air filter 90€+V.A.T.

■ **3.100 €** + V.A.T.

Icemakers

series CP **ALSTARCO**
ICE PLEASE!

FULL ICE CUBE

CP 100.60

FULL ICE CUBE ICEMAKER

DIMENSIONS: 740x605x1015 mm
FEET: + (40-50 mm)
OUTPUT: 100 kg (≈ 5556 ice cubes) / 24h
STORAGE CAPACITY: 60 kg
POWER / VOLTAGE: 1200 W / 230V/50Hz
REFRIGERANT: R452a
COOLING SYSTEM: Air cooled / Water cooled

INFO

Ice cubes/cycle: 64
Type: Solid ice cube 18gr

EXTRA

Air filter 90€+V.A.T.

■ **3.200 €** + V.A.T.

CP 130.75

FULL ICE CUBE ICEMAKER

DIMENSIONS: 840x745x1070 mm
FEET: + (40-50 mm)
OUTPUT: 130 kg (≈ 7222 ice cubes) / 24h
STORAGE CAPACITY: 75 kg
POWER / VOLTAGE: 1250 W / 230V/50Hz
REFRIGERANT: R452a
COOLING SYSTEM: Air cooled / Water cooled

INFO

Ice cubes/cycle: 108
Type: Solid ice cube 18gr

EXTRA

Air filter 90€+V.A.T.

■ **4.250 €** + V.A.T.

CP 165.75

FULL ICE CUBE ICEMAKER

DIMENSIONS: 840x745x1070 mm
FEET: + (40-50 mm)
OUTPUT: 165 kg (≈ 9167 ice cubes) / 24h
STORAGE CAPACITY: 75 kg
POWER / VOLTAGE: 1900 W / 230V/50Hz
REFRIGERANT: R452a
COOLING SYSTEM: Air cooled / Water cooled

INFO

Ice cubes/cycle: 108
Type: Solid ice cube 18gr

EXTRA

Air filter 90€+V.A.T.

■ **4.450 €** + V.A.T.



i Daily production is estimated at 21°C room temperature and 15°C water temperature

Reduced water consumption



Energy efficiency

Reduced maintenance costs



100% made in Italy

AIR FILTER



CP 165

FULL ICE CUBE ICEMAKER WITHOUT STORAGE BIN

DIMENSIONS: 865x560x810 mm
OUTPUT: 165 kg (≈ 9167 ice cubes) / 24h
POWER / VOLTAGE: 1900 W / 230V/50Hz
REFRIGERANT: R452a
COOLING SYSTEM: Air cooled / Water cooled

INFO

Ice cubes/cycle: 108
Type: Solid ice cube 18gr

Suitable storage bin:

STS 250 | STS 400 (p. 142)

EXTRA

Air filter 90€+V.A.T.

■ **4.250 €** + V.A.T.

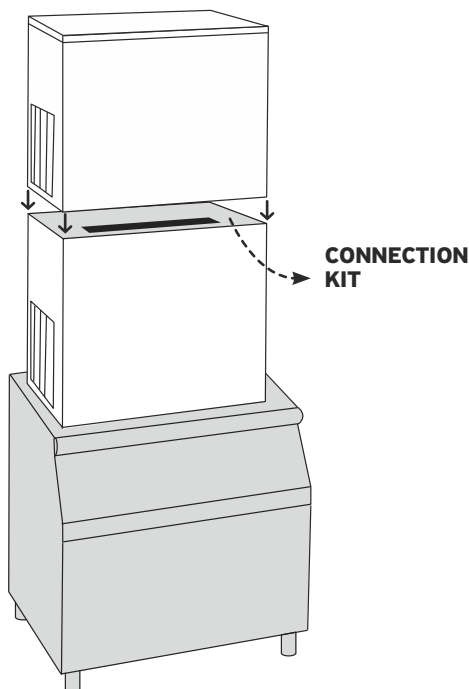

CP 300

FULL ICE CUBE ICEMAKER WITHOUT STORAGE BIN

DIMENSIONS: 1255x595x860 mm
OUTPUT: 300 kg (≈ 16667 ice cubes) / 24h
POWER / VOLTAGE: 2700 W / 230V/50Hz
REFRIGERANT: R452a
COOLING SYSTEM: Air cooled / Water cooled

INFO

Ice cubes/cycle: 108
Type: Solid ice cube 18gr

Suitable storage bin:

STS 400 (p. 142)

EXTRA

Air filter 90€+V.A.T.

■ **6.890 €** + V.A.T.

Icemakers

FULL ICE CUBE

series CS **ALSTARCO**
ICE PLEASE!

CS 25.6

FULL ICE CUBE ICEMAKER

DIMENSIONS: 365x495x600 mm
FEET: + (0-20 mm)
OUTPUT: 25 kg (≈ 625 ice cubes) / 24h
STORAGE CAPACITY: 6 kg
POWER / VOLTAGE: 450 W / 230V/50Hz
REFRIGERANT: R452a
COOLING SYSTEM: Air cooled / Water cooled

INFO

Ice cubes/cycle: 18
Type: Solid ice cube 36gr

EXTRA

Air filter 90€+V.A.T.

■ **1.540 €** + V.A.T.

CS 30.10

FULL ICE CUBE ICEMAKER

DIMENSIONS: 365x495x690 mm
FEET: + (0-20 mm)
OUTPUT: 30 kg (≈ 750 ice cubes) / 24h
STORAGE CAPACITY: 10 kg
POWER / VOLTAGE: 450 W / 230V/50Hz
REFRIGERANT: R452a
COOLING SYSTEM: Air cooled / Water cooled

INFO

Ice cubes/cycle: 18
Type: Solid ice cube 36gr

EXTRA

Air filter 90€+V.A.T.

■ **1.650 €** + V.A.T.

CS 37.15

FULL ICE CUBE ICEMAKER

DIMENSIONS: 500x585x685 mm
FEET: + (0-20 mm)
OUTPUT: 37 kg (≈ 1250 ice cubes) / 24h
STORAGE CAPACITY: 15 kg
POWER / VOLTAGE: 570 W / 230V/50Hz
REFRIGERANT: R452a
COOLING SYSTEM: Air cooled / Water cooled

INFO

Ice cubes/cycle: 24
Type: Solid ice cube 36gr

EXTRA

Air filter 90€+V.A.T.

■ **1.890 €** + V.A.T.

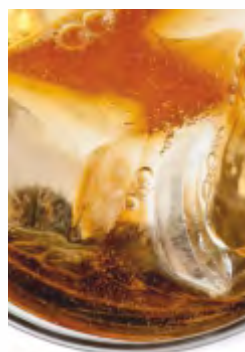

Solid Ice Cube
36gr



- High density, pure, crystal clear solid ice cubes
- Made entirely of stainless steel
- Maximum efficiency
- Latest technology
- Compressor Tropical
- Attractive and ergonomic design



Daily production is estimated
at 21°C room temperature
and 15°C water temperature

Reduced
water
consumption



Energy
efficiency

Reduced
maintenance
costs



100%
made in Italy

CS 45.15

FULL ICE CUBE ICEMAKER

DIMENSIONS: 500x585x685 mm
FEET: + (0-20 mm)
OUTPUT: 45 kg (≈ 1250 ice cubes) / 24h
STORAGE CAPACITY: 15 kg
POWER / VOLTAGE: 600 W / 230V/50Hz
REFRIGERANT: R452a
COOLING SYSTEM: Air cooled / Water cooled

INFO

Ice cubes/cycle: 24
Type: Solid ice cube 36gr

EXTRA

Air filter 90€+V.A.T.

■ **2.060 €** + V.A.T.

CS 60.40

FULL ICE CUBE ICEMAKER

DIMENSIONS: 740x605x915 mm
FEET: + (40-50 mm)
OUTPUT: 60 kg (≈ 1667 ice cubes) / 24h
STORAGE CAPACITY: 40 kg
POWER / VOLTAGE: 780 W / 230V/50Hz
REFRIGERANT: R452a
COOLING SYSTEM: Air cooled / Water cooled

INFO

Ice cubes/cycle: 36
Type: Solid ice cube 36gr

EXTRA

Air filter 90€+V.A.T.

■ **2.880 €** + V.A.T.



CS 50.25

FULL ICE CUBE ICEMAKER

DIMENSIONS: 500x585x795 mm
FEET: + (0-20 mm)
OUTPUT: 50 kg (≈ 1390 ice cubes) / 24h
STORAGE CAPACITY: 25 kg
POWER / VOLTAGE: 750 W / 230V/50Hz
REFRIGERANT: R452a
COOLING SYSTEM: Air cooled / Water cooled

INFO

Ice cubes/cycle: 24
Type: Solid ice cube 36gr

EXTRA

Air filter 90€+V.A.T.

■ **2.150 €** + V.A.T.

CS 80.40

FULL ICE CUBE ICEMAKER

DIMENSIONS: 740x605x915 mm
FEET: + (40-50 mm)
OUTPUT: 80 kg (≈ 2222 ice cubes) / 24h
STORAGE CAPACITY: 40 kg
POWER / VOLTAGE: 1050 W / 230V/50Hz
REFRIGERANT: R452a
COOLING SYSTEM: Air cooled / Water cooled

INFO

Ice cubes/cycle: 36
Type: Solid ice cube 36gr

EXTRA

Air filter 90€+V.A.T.

■ **3.120 €** + V.A.T.

CS 90.60

FULL ICE CUBE ICEMAKER

DIMENSIONS: 740x605x1015 mm
FEET: + (40-50 mm)
OUTPUT: 90 kg (≈ 2500 ice cubes) / 24h
STORAGE CAPACITY: 60 kg
POWER / VOLTAGE: 1200 W / 230V/50Hz
REFRIGERANT: R452a
COOLING SYSTEM: Air cooled / Water cooled

INFO

Ice cubes/cycle: 36
Type: Solid ice cube 36gr

EXTRA

Air filter 90€+V.A.T.

■ **3.390 €** + V.A.T.

Icemakers

series CS **ALSTARCO**
ICE PLEASE!

FULL ICE CUBE

CS 130.75

FULL ICE CUBE ICEMAKER

DIMENSIONS: 840x745x1070 mm
FEET: + (40-50 mm)
OUTPUT: 130 kg (≈ 3611 ice cubes) / 24h
STORAGE CAPACITY: 75 kg
POWER / VOLTAGE: 1250 W / 230V/50Hz
REFRIGERANT: R452a
COOLING SYSTEM: Air cooled / Water cooled

INFO

Ice cubes/cycle: 36
Type: Solid ice cube 36gr

EXTRA

Air filter 90€+V.A.T.

■ **4.200 €** + V.A.T.



Reduced water consumption



Energy efficiency

Reduced maintenance costs



100% made in Italy

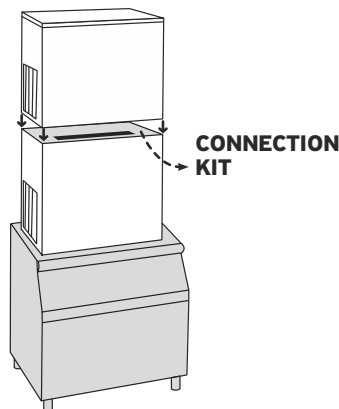

CS 140

FULL ICE CUBE ICEMAKER WITHOUT STORAGE BIN

DIMENSIONS: 865x560x810 mm
OUTPUT: 140 kg (≈ 3889 ice cubes) / 24h
POWER / VOLTAGE: 1900 W / 230V/50Hz
REFRIGERANT: R452a
COOLING SYSTEM: Air cooled / Water cooled

INFO

Ice cubes/cycle: 60
Type: Solid ice cube 36gr

Suitable storage bin:

STS 250 | STS 400 (p. 142)

EXTRA

Air filter 90€+V.A.T.

■ **4.200 €** + V.A.T.

CS 280

FULL ICE CUBE ICEMAKER WITHOUT STORAGE BIN

DIMENSIONS: 1255x595x860 mm
OUTPUT: 280 kg (≈ 7778 ice cubes) / 24h
POWER / VOLTAGE: 2700 W / 230V/50Hz
REFRIGERANT: R452a
COOLING SYSTEM: Air cooled / Water cooled

INFO

Ice cubes/cycle: 120
Type: Solid ice cube 36gr

Suitable storage bin:

STS 400 (p. 142)

EXTRA

Air filter 90€+V.A.T.

■ **6.890 €** + V.A.T.

Icemakers

HOLLOW ICE CUBE

series CV **ARSTARCO**
ICE PLEASE!



- High density, pure, crystal clear ice cubes
- Made entirely of stainless steel
- Maximum efficiency
- Latest technology
- Compressor Tropical
- Attractive and ergonomic design



Daily production is estimated at 21°C room temperature and 15°C water temperature



Reduced water consumption



Energy efficiency



Reduced maintenance costs



100% made in Italy

CV 20.5

HOLLOW ICE CUBE ICEMAKER

DIMENSIONS: 340x545x620 mm
FEET: + (0-10 mm)
OUTPUT: 20 kg (≈ 1176 ice cubes) / 24h
STORAGE CAPACITY: 5 kg
POWER / VOLTAGE: 250 W / 230V/50Hz
REFRIGERANT: R134a
COOLING SYSTEM: Air cooled / Water cooled

INFO

Ice cubes/cycle: 15
Type: Hollow ice cube 17gr

■ **1.700 €** + V.A.T.

CV 35.12

HOLLOW ICE CUBE ICEMAKER

DIMENSIONS: 450x545x690 mm
FEET: + (0-10 mm)
OUTPUT: 35 kg (≈ 2058 ice cubes) / 24h
STORAGE CAPACITY: 12 kg
POWER / VOLTAGE: 350 W / 230V/50Hz
REFRIGERANT: R134a
COOLING SYSTEM: Air cooled / Water cooled

INFO

Ice cubes/cycle: 20
Type: Hollow ice cube 17gr

■ **2.090 €** + V.A.T.

CV 25.7

HOLLOW ICE CUBE ICEMAKER

DIMENSIONS: 340x545x690 mm
FEET: + (0-10 mm)
OUTPUT: 25 kg (≈ 1470 ice cubes) / 24h
STORAGE CAPACITY: 7 kg
POWER / VOLTAGE: 250 W / 230V/50Hz
REFRIGERANT: R134a
COOLING SYSTEM: Air cooled / Water cooled

INFO

Ice cubes/cycle: 15
Type: Hollow ice cube 17gr

■ **1.850 €** + V.A.T.

CV 45.16

HOLLOW ICE CUBE ICEMAKER

DIMENSIONS: 500x600x690 mm
FEET: + (0-10 mm)
OUTPUT: 45 kg (≈ 2647 ice cubes) / 24h
STORAGE CAPACITY: 16 kg
POWER / VOLTAGE: 370 W / 230V/50Hz
REFRIGERANT: R134a
COOLING SYSTEM: Air cooled / Water cooled

INFO

Ice cubes/cycle: 35
Type: Hollow ice cube 17gr

■ **2.450 €** + V.A.T.

Icemakers

HOLLOW ICE CUBE

series CV **ALSTARCO**
ICE PLEASE!

CV 50.21

HOLLOW ICE CUBE ICEMAKER

DIMENSIONS: 500x585x880 mm
FEET: + (80-100 mm)
OUTPUT: 50 kg (≈ 2941 ice cubes) / 24h
STORAGE CAPACITY: 21 kg
POWER / VOLTAGE: 370 W / 230V/50Hz
REFRIGERANT: R134a
COOLING SYSTEM: Air cooled / Water cooled

INFO

Ice cubes/cycle: 35
Type: Hollow ice cube 17gr

■ **2.650 €** + V.A.T.



CV 60.28

HOLLOW ICE CUBE ICEMAKER

DIMENSIONS: 600x585x880 mm
FEET: + (80-100 mm)
OUTPUT: 60 kg (≈ 3529 ice cubes) / 24h
STORAGE CAPACITY: 28 kg
POWER / VOLTAGE: 570 W / 230V/50Hz
REFRIGERANT: R134a
COOLING SYSTEM: Air cooled / Water cooled

INFO

Ice cubes/cycle: 35
Type: Hollow ice cube 17gr

■ **3.150 €** + V.A.T.



Reduced
water
consumption



Energy
efficiency

Reduced
maintainance
costs



100%
made in Italy

CV 90.40

HOLLOW ICE CUBE ICEMAKER

DIMENSIONS: 800x585x880 mm
FEET: + (80-100 mm)
OUTPUT: 90 kg (≈ 5294 ice cubes) / 24h
STORAGE CAPACITY: 40 kg
POWER / VOLTAGE: 790 W / 230V/50Hz
REFRIGERANT: R134a
COOLING SYSTEM: Air cooled / Water cooled

INFO

Ice cubes/cycle: 60
Type: Hollow ice cube 17gr

■ **3.750 €** + V.A.T.



Παγάκι με τρύπα
17gr

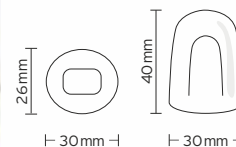

Daily production is estimated
at 21°C room temperature
and 15°C water temperature

Granular Ice

series SG **ALSTARCO**
ICE PLEASE!



Reduced water consumption



Energy efficiency

Reduced maintenance costs



100% made in Italy



- High density, pure, crystal clear ice
- Made entirely of stainless steel
- Maximum efficiency
- Latest technology
- Attractive and ergonomic design
- Vertical pump



Daily production is estimated at 21°C room temperature and 15°C water temperature

SG 100.15

GRANULAR ICEMAKER WITH STORAGE BIN

DIMENSIONS: 500x670x696 mm
FEET: + (40-50 mm)
OUTPUT: 100 kg / 24h
STORAGE CAPACITY: 15 kg
POWER / VOLTAGE: 700 W / 230V/50Hz
REFRIGERANT: R452a
COOLING SYSTEM: Air cooled / Water cooled

INFO

Type: Granular ice

EXTRA

Air filter 90€+V.A.T.

■ **3.640 €** + V.A.T.

SG 140.25

GRANULAR ICEMAKER WITH STORAGE BIN

DIMENSIONS: 500x670x796 mm
FEET: + (40-50 mm)
OUTPUT: 140 kg / 24h
STORAGE CAPACITY: 25 kg
POWER / VOLTAGE: 700 W / 230V/50Hz
REFRIGERANT: R452a
COOLING SYSTEM: Air cooled / Water cooled

INFO

Type: Granular ice

EXTRA

Air filter 90€+V.A.T.

■ **4.350 €** + V.A.T.

SG 140.60

GRANULAR ICEMAKER WITH STORAGE BIN

DIMENSIONS: 740x700x934 mm
FEET: + (40-50 mm)
OUTPUT: 140 kg / 24h
STORAGE CAPACITY: 60 kg
POWER / VOLTAGE: 700 W / 230V/50Hz
REFRIGERANT: R452a
COOLING SYSTEM: Air cooled / Water cooled

INFO

Type: Granular ice

EXTRA

Air filter 90€+V.A.T.

■ **4.600 €** + V.A.T.

Granular Ice

series SG **ALSTARCO**
ICE PLEASE!

SG 140

GRANULAR ICEMAKER WITH STORAGE BIN

DIMENSIONS: 560x525x560 mm
OUTPUT: 140 kg / 24h
POWER / VOLTAGE: 700 W / 230V/50Hz
REFRIGERANT: R452a
COOLING SYSTEM: Air cooled / Water cooled

INFO

Type: Granular ice
Suitable storage bin:
STS 150 | STS 200 | STS250 | STC140 (p. 142-143)

EXTRA

Air filter 90€+V.A.T.

■ **4.150 €** + V.A.T.



SG 300

GRANULAR ICEMAKER WITH STORAGE BIN

DIMENSIONS: 560x525x560 mm
OUTPUT: 300 kg / 24h
POWER / VOLTAGE: 1300 W / 230V/50Hz
REFRIGERANT: R452a
COOLING SYSTEM: Air cooled / Water cooled

INFO

Type: Granular ice
Suitable storage bin:
STS 150 | STS 200 | STS250 | STS400 | STC140 |
STC300 (p. 142-143)

EXTRA

Air filter 90€+V.A.T.

■ **5.690 €** + V.A.T.



Daily production is estimated
at 21°C room temperature
and 15°C water temperature

SG 600

GRANULAR ICEMAKER WITH STORAGE BIN

DIMENSIONS: 605x570x725 mm
OUTPUT: 600 kg / 24h
POWER / VOLTAGE: 2000 W / 230V/50Hz
REFRIGERANT: R452a
COOLING SYSTEM: Air cooled / Water cooled

INFO

Type: Granular ice
Suitable storage bin:
STS 200 | STS250 | STS400 | STSD500 | STC300 |
STC600 (p. 142-143)

EXTRA

Air filter 90€+V.A.T.

■ **7.170 €** + V.A.T.

Reduced
water
consumption



Energy
efficiency

Reduced
maintainance
costs



100%
made in Italy

**AIR
FILTER**

90€+V.A.T.



Flat Ice Flake

series SPS **ALSTARCO**
ICE PLEASE!



Flat Ice Flakes
thickness
1,5 mm



- Made entirely of stainless steel
- Maximum efficiency
- Latest technology
- Attractive and ergonomic design

i Daily production is estimated
at 21°C room temperature
and 15°C water temperature



Reduced
water
consumption



Energy
efficiency



Reduced
maintenance
costs



100%
made in Italy

SPS 250

FLAT FLAKE ICEMAKER

DIMENSIONS: 1015x590x765 mm
FEET: + (20-50 mm)
OUTPUT: 250 kg / 24h
POWER / VOLTAGE: 1000 W / 230V/50Hz
REFRIGERANT: R452a
COOLING SYSTEM: Air cooled

INFO
Type: Flat ice flakes

Suitable storage bin:
STS400 | STSD500 | STC600 (p. 142-143)

■ **11.950 €** + V.A.T.

SPS 1000

FLAT FLAKE ICEMAKER

DIMENSIONS: 1110x640x800 mm
FEET: + (20-50 mm)
OUTPUT: 1000 kg / 24h
POWER / VOLTAGE: 4500 W / 230V/50Hz
REFRIGERANT: R452a
COOLING SYSTEM: Air cooled

INFO
Type: Flat ice flakes

Suitable storage bin:
STS400 | STSD500 | STSD1000 | STC600 (p. 142-143)

■ **18.350 €** + V.A.T.

SPS 600

FLAT FLAKE ICEMAKER

DIMENSIONS: 1110x640x800 mm
FEET: + (20-50 mm)
OUTPUT: 600 kg / 24h
POWER / VOLTAGE: 2600 W / 230V/50Hz
REFRIGERANT: R452a
COOLING SYSTEM: Air cooled

INFO
Type: Flat ice flakes

Suitable storage bin:
STS400 | STSD500 | STSD1000 | STC600 (p. 142-143)

■ **14.330 €** + V.A.T.

SPS 1500

FLAT FLAKE ICEMAKER

DIMENSIONS: 1380x740x970 mm
FEET: + (20-50 mm)
OUTPUT: 1500 kg / 24h
POWER / VOLTAGE: 5500 W / 230V/50Hz
REFRIGERANT: R452a
COOLING SYSTEM: Air cooled

INFO
Type: Flat ice flakes

Suitable storage bin:
STSD1000 | STC600 (p. 143)

■ **25.100 €** + V.A.T.

Storage Bins

series STS **ALSTARCO**
ICE PLEASE!

STS 150

STORAGE BIN

DIMENSIONS: 569x850(1034)x1048 mm
CAPACITY: 130 kg

INFO

Suitable for:
SG140 | SG300

■ **1.860 €** + V.A.T.

STS 200

STORAGE BIN

DIMENSIONS: 769x850(1034)x1048 mm
CAPACITY: 180 kg

INFO

Suitable for:
SG140 | SG300 | SG600

■ **1.960 €** + V.A.T.

STS 250

STORAGE BIN

DIMENSIONS: 1081x824(944)x968 mm
CAPACITY: 250 kg

INFO

Suitable for:
CP165 | CS140 | SG140 | SG300 | SG600

■ **2.680 €** + V.A.T.

STS 400

STORAGE BIN

DIMENSIONS: 1235x873(1155)x1270 mm
CAPACITY: 400 kg

INFO

Suitable for:
CP165 | CP300 | CS140 | CS280 | SG140 | SG300 |
SG600 | SPS250 | SPS600 | SPS1000

■ **3.200 €** + V.A.T.

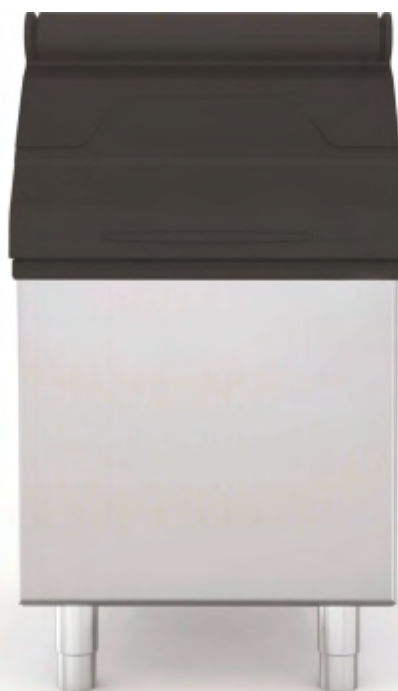

- Made entirely of stainless steel
- Maximum efficiency
- Latest technology
- Attractive and ergonomic design

Reduced water consumption



Energy efficiency

Reduced maintenance costs



100% made in Italy



STSD 500

STORAGE BIN

DIMENSIONS: 1220x1128(1410)x1427 mm
CAPACITY: 550 kg

INFO

Suitable for:
SG600 | SPS250 | SPS600 | SPS1000

■ **8.390 €** + V.A.T.



STC 140

STORAGE BIN WITH CART

DIMENSIONS: 885x1025(1169)x1343 mm
CAPACITY: 137+73 kg

INFO

Suitable for:
SG140 | Sg300

■ **7.450 €** + V.A.T.

STSD 1000

STORAGE BIN

DIMENSIONS: 1830x1470(1750)x1290 mm
CAPACITY: 550 kg

INFO

Suitable for:
SPS600 | SPS1000 | SPS1500

■ **11.740 €** + V.A.T.

STC 300

STORAGE BIN WITH CART

DIMENSIONS: 885x1267(1553)x1803 mm
CAPACITY: 318+73 kg

INFO

Suitable for:
SG300 | Sg600

■ **9.980 €** + V.A.T.

STC 600

STORAGE BIN WITH 2 CARTS

DIMENSIONS: 1753x1267(1535)x1803 mm
CAPACITY: 613+146 kg

INFO

Suitable for:
SG600 | SPS250 | SPS600 | SPS1000 | SPS1500

■ **17.200 €** + V.A.T.

Icemakers

HOLLOW ICE CUBE

plum
FOOD SERVICE SOLUTIONS

SD 31

HOLLOW ICE CUBE ICEMAKER

DIMENSIONS: 375x575x762 mm
OUTPUT: 25 kg / 24h
STORAGE CAPACITY: 15 kg
POWER / VOLTAGE: 300 W / 230V/50Hz
REFRIGERANT: R290
COOLING SYSTEM: Air cooled

INFO

Type: Hollow ice cube Z 28x39 mm, 15gr

■ **1.260 €** + V.A.T.



SD 41

HOLLOW ICE CUBE ICEMAKER

DIMENSIONS: 375x575x762 mm
OUTPUT: 35 kg / 24h
STORAGE CAPACITY: 15 kg
POWER / VOLTAGE: 320 W / 230V/50Hz
REFRIGERANT: R290
COOLING SYSTEM: Air cooled

INFO

Type: Hollow ice cube Z 28x39 mm, 15gr

■ **1.470 €** + V.A.T.



Hollow Ice Cube
15gr



Daily production is estimated
at 21°C room temperature
and 10°C water temperature

SDU 61

HOLLOW ICE CUBE ICEMAKER

DIMENSIONS: 667x637x775 mm
OUTPUT: 55 kg / 24h
STORAGE CAPACITY: 30 kg
POWER / VOLTAGE: 500 W / 230V/50Hz
REFRIGERANT: R290
COOLING SYSTEM: Air cooled

INFO

Type: Hollow ice cube Z 28x39 mm, 15gr

■ **2.790 €** + V.A.T.



Icemakers

DICE ICE CUBE

plum
FOOD SERVICE SOLUTIONS

SQ 61



SQ 61PT



SQ 100



SQU 81



Dice Ice Cube
16gr
17gr
20gr

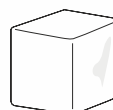

Daily production is estimated
at 21°C room temperature
and 10°C water temperature

SQ 61

DICE ICE CUBE ICEMAKER

DIMENSIONS: 500x590x850 mm
OUTPUT: 55 kg / 24h
ΑΠΟΘΗΚΗ: 18 kg
POWER / VOLTAGE: 360 W / 230V/50Hz
REFRIGERANT: R290
COOLING SYSTEM: Air cooled

INFO

Type: Dice Ice Cube 28x32x22mm 16gr

■ **1.740 €** + V.A.T.

SQ 61PT

DICE ICE CUBE ICEMAKER

DIMENSIONS: 500x590x850 mm
OUTPUT: 55 kg / 24h
ΑΠΟΘΗΚΗ: 18 kg
POWER / VOLTAGE: 300 W / 230V/50Hz
REFRIGERANT: R290
COOLING SYSTEM: Air cooled

INFO

Type: Dice Ice Cube 28x32x22mm 16gr

■ **1.830 €** + V.A.T.

SQU 81

DICE ICE CUBE ICEMAKER

DIMENSIONS: 660x640x785 mm
OUTPUT: 80 kg / 24h
ΑΠΟΘΗΚΗ: 25 kg
POWER / VOLTAGE: 420 W / 230V/50Hz
REFRIGERANT: R404a
COOLING SYSTEM: Air cooled

INFO

Type: Dice Ice Cube 28x32x22mm 16gr

■ **2.940 €** + V.A.T.

SQ 100

DICE ICE CUBE ICEMAKER

DIMENSIONS: 660x685x920 mm
OUTPUT: 95 kg / 24h
ΑΠΟΘΗΚΗ: 36 kg
POWER / VOLTAGE: 580 W / 230V/50Hz
REFRIGERANT: R404a
COOLING SYSTEM: Air cooled

INFO

Type: Dice Ice Cube 28x32x22mm 16gr

■ **2.600 €** + V.A.T.

Icemakers

DICE ICE CUBE

plum
FOOD SERVICE SOLUTIONS

SQ 130

DICE ICE CUBE ICEMAKER

DIMENSIONS: 660x685x920 mm
OUTPUT: 130 kg / 24h
STORAGE CAPACITY: 36 kg
POWER / VOLTAGE: 580 W / 230V/50Hz
REFRIGERANT: R290
COOLING SYSTEM: Air cooled

INFO

Type: Dice Ice 32x32x22 mm 17 gr

■ **3.240 €** + V.A.T.



SQ 231

DICE ICE CUBE ICEMAKER WITHOUT STORAGE BIN

DIMENSIONS: 760x830x620 mm
OUTPUT: 225 kg / 24h
POWER / VOLTAGE: 1240 W / 230V/50Hz
REFRIGERANT: R290
COOLING SYSTEM: Air cooled

INFO

Type: Dice Ice 38x38x22 mm 20 gr

Suitable storage bin:

BIN200 | BIN360

■ **4.650 €** + V.A.T.



SQ 231 + BIN 200

SQ 501

DICE ICE CUBE ICEMAKER WITHOUT STORAGE BIN

DIMENSIONS: 760x830x795 mm
OUTPUT: 455 kg / 24h
POWER / VOLTAGE: 2300 W / 230V/50Hz
REFRIGERANT: R404a
COOLING SYSTEM: Air cooled

INFO

Type: Dice Ice 38x38x22 mm 20 gr

Suitable storage bin:

BIN200 | BIN360

■ **6.450 €** + V.A.T.





BIN 200

STORAGE BIN

DIMENSIONS: 760x830x1 100 mm

CAPACITY: 170 kg

INFO

Suitable for:
SQ231 | Sq501

■ **1.170 €** + V.A.T..

BIN 360

STORAGE BIN

DIMENSIONS: 1 227x973x1 245 mm

CAPACITY: 350 kg

INFO

Suitable for:
SQ501 | SQ231
Connection kit required

EXTRA

CONNECTION KIT 200 € + V.A.T.

■ **1.990 €** + V.A.T..

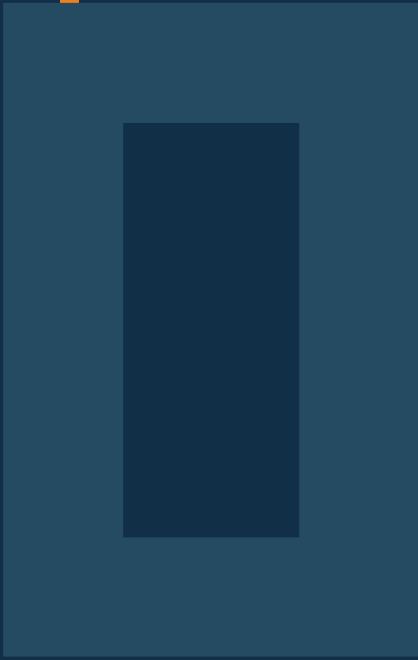

I

N

O

X

INOX

GREASE COLLECTORS [150]

HAND SINKS HACCP [151]

WASTE CONTAINERS [151]

GLASSWARE CABINETS [152]

RACKS [152]

CABINETS [153]

WORKING TABLES [154]

TABLES WITH SINK [156]

REFRIGERATED COUNTERS [159]

COOLING CABINETS [160]

FREEZING CABINETS [161]

GASTRONORME CONTAINERS [162]

TABLES WITH SINK [156]

REFRIGERATED COUNTERS [159]

COOLING CABINETS [160]

FREEZING CABINETS [161]

GASTRONORME CONTAINERS [162]

Grease collectors



OWS 30

GREASE COLLECTOR 30 lt

DIMENSIONS: 568x318x312 mm
CAPACITY: 30 lt

INFO

Stainless steel construction
Input & output diameter Ø 50 mm

■ **190 €** + V.A.T.

OWS 60

GREASE COLLECTOR 60 lt

DIMENSIONS: 647x376x400 mm
CAPACITY: 60 lt

INFO

Stainless steel construction
Input & output diameter Ø 50 mm

■ **254 €** + V.A.T.

OWS 180

GREASE COLLECTOR 180 lt

DIMENSIONS: 823x521x627 mm
CAPACITY: 180 lt

INFO

Stainless steel construction
Input & output diameter Ø 50 mm

■ **395 €** + V.A.T.

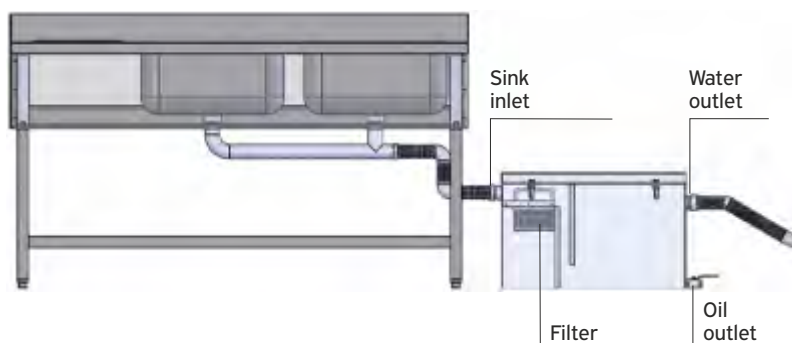

Hand sinks Haccp



700430

WALL MOUNTED HAND SINK HACCP

DIMENSIONS: 400x340x585 mm (200+385 mm)

INFO

Stainless steel construction
Thermomix valve
Knee operated
Full hydraulic equipment

■ **220 €** + V.A.T.



800430

FLOOR MOUNTED HAND SINK HACCP

DIMENSIONS: 400x510x878 mm (850+28 mm)

INFO

Stainless steel construction
Thermomix valve
Foot operated
Full hydraulic equipment

■ **420 €** + V.A.T.

Waste containers



900904

WASTE CONTAINER

DIMENSIONS: Ø 380x630 mm
CAPACITY: 60 lt

INFO

Stainless steel construction
Rubber castors

■ **140 €** + V.A.T.



900470

WASTE CONTAINER

DIMENSIONS: 700x400x770 mm
CAPACITY: 120 lt

INFO

Stainless steel construction
Rubber castors

■ **320 €** + V.A.T.

Glassware cabinets

501240

GLASSWARE CABINET

DIMENSIONS: 1200x400x650 mm
DOORS: 2

■ **380 €** + V.A.T.



INFO

Stainless steel construction
Durable shelf
Stainless steel sliding doors

501440

GLASSWARE CABINET

DIMENSIONS: 1400x400x650 mm
DOORS: 2

■ **400 €** + V.A.T.

501540

GLASSWARE CABINET

DIMENSIONS: 1500x400x650 mm
DOORS: 2

■ **420 €** + V.A.T.

Racks

VE 412SR

INOX RACK

DIMENSIONS: 1200x500x1550 mm
SHELVES: 4 stable

■ **420 €** + V.A.T.

VE 415SR

INOX RACK

DIMENSIONS: 1500x500x1550 mm
SHELVES: 4 stable

■ **460 €** + V.A.T.



INFO

Stainless steel construction
Easy to assemble

Cabinets



247085

CABINET

DIMENSIONS: 1400x700x850 mm
DOORS: 2

INFO

Stainless steel construction
Durable shelf
Stainless steel sliding doors

■ **680 €** + V.A.T.

267085

CABINET

DIMENSIONS: 1600x700x850 mm
DOORS: 2

INFO

Stainless steel construction
Durable shelf
Stainless steel sliding doors

■ **840 €** + V.A.T.

287085

CABINET

DIMENSIONS: 1800x700x850 mm
DOORS: 2

INFO

Stainless steel construction
Durable shelf
Stainless steel sliding doors

■ **870 €** + V.A.T.

Working tables



601070

WORKING TABLE

DIMENSIONS: 1 000x700x850 mm

INFO

Stainless steel construction
Durable shelf
Easy to assemble

■ **290 €** + V.A.T.

601270

WORKING TABLE

DIMENSIONS: 1 200x700x850 mm

INFO

Stainless steel construction
Durable shelf
Easy to assemble

■ **310 €** + V.A.T.

601470

WORKING TABLE

DIMENSIONS: 1 400x700x850 mm

INFO

Stainless steel construction
Durable shelf
Easy to assemble

■ **340 €** + V.A.T.

Inox mirror working tables



VEG 044	450x450x650 mm	■ 135 € + V.A.T.
VEG 064	600x450x650 mm	■ 140 € + V.A.T.
VEG 074	750x450x650 mm	■ 150 € + V.A.T.
VEG 094	900x450x650 mm	■ 160 € + V.A.T.
VEG 124	1200x450x650 mm	■ 170 € + V.A.T.
VEG 066	600x600x650 mm	■ 160 € + V.A.T.
VEG 076	700x600x650 mm	■ 180 € + V.A.T.
VEG 096	900x600x650 mm	■ 200 € + V.A.T.
VEG 126	1200x600x650 mm	■ 220 € + V.A.T.
VE 044	450x450x800 mm	■ 135 € + V.A.T.
VE 064	600x450x800 mm	■ 145 € + V.A.T.
VE 074	750x450x800 mm	■ 155 € + V.A.T.
VE 094	900x450x800 mm	■ 165 € + V.A.T.
VE 124	120x450x800 mm	■ 185 € + V.A.T.
VE 046	450x600x800 mm	■ 175 € + V.A.T.
VE 066	600x600x800 mm	■ 200 € + V.A.T.
VE 076	750x600x800 mm	■ 230 € + V.A.T.
VE 096	900x600x800 mm	■ 250 € + V.A.T.
VE 126	1200x600x800 mm	■ 270 € + V.A.T.

PLUS Inox mirror

INFO Easy to assemble

Tables with sink

607095

TABLE WITH SINGLE SINK

DIMENSIONS: 600x700x950 mm
SINK DIMENSIONS: 400x500x250 mm
SINKS: 1

INFO

Stainless steel construction
Durable shelf
Backsplash
Easy to assemble

■ 495 € + V.A.T.



1207095

TABLE WITH SINGLE SINK

DIMENSIONS: 1200x700x950 mm
SINK DIMENSIONS: 1060x500x250 mm
SINKS: 1

INFO

Stainless steel construction
Durable shelf
Backsplash
Easy to assemble

■ 690 € + V.A.T.



107095 L

TABLE WITH SINGLE SINK

DIMENSIONS: 1000x700x950 mm
SINK DIMENSIONS: 400x500x250 mm
SINKS: 1

INFO

Stainless steel construction
Durable shelf
Backsplash
Easy to assemble

■ 630 € + V.A.T.



107095 R

TABLE WITH SINGLE SINK

DIMENSIONS: 1000x700x950 mm
SINK DIMENSIONS: 400x500x250 mm
SINKS: 1

INFO

Stainless steel construction
Durable shelf
Backsplash
Easy to assemble

■ 630 € + V.A.T.





127095 L

TABLE WITH SINGLE SINK

DIMENSIONS: 1200x700x950 mm
SINK DIMENSIONS: 500x500x250 mm
SINKS: 1

INFO

Stainless steel construction
Durable shelf
Backsplash
Easy to assemble

■ 650 € + V.A.T.



127095 R

TABLE WITH SINGLE SINK

DIMENSIONS: 1200x700x950 mm
SINK DIMENSIONS: 500x500x250 mm
SINKS: 1

INFO

Stainless steel construction
Durable shelf
Backsplash
Easy to assemble

■ 650 € + V.A.T.



167095 L

TABLE WITH DOUBLE SINK

DIMENSIONS: 1600x700x950 mm
SINK DIMENSIONS: 400x500x250 mm
SINKS: 2

INFO

Stainless steel construction
Durable shelf
Backsplash
Easy to assemble

■ 730 € + V.A.T.



167095

TABLE WITH DOUBLE SINK

DIMENSIONS: 1600x700x950 mm
SINK DIMENSIONS: 400x500x250 mm

INFO

Stainless steel construction
Durable shelf
Backsplash
Easy to assemble

■ 730 € + V.A.T.

Inox mirror tables with sink



VE 2096

TABLE WITH DOUBLE SINK

DIMENSIONS: 900x600x800 mm
SINK DIMENSIONS: 360x410x230 mm
SINKS: 2

■ 525 € + V.A.T.

VE 2106

TABLE WITH DOUBLE SINK

DIMENSIONS: 1000x600x800 mm
SINK DIMENSIONS: 410x460x230 mm
SINKS: 2

■ 545 € + V.A.T.

VE 2126

TABLE WITH DOUBLE SINK

DIMENSIONS: 1200x600x800 mm
SINK DIMENSIONS: 360x410x230 mm
SINKS: 2

■ 565 € + V.A.T.

PLUS
Backsplash • Inox mirror

INFO
Easy to assemble • Full hydraulic equipment included

Refrigerated counters



312100

REFRIGERATED COUNTER

DIMENSIONS: 1360x700x860 mm
CAPACITY: 260 lt
DOORS: 2
GRIDS: 2 (53x32,5 cm) plastic laminated
COOLING/DEFROST: Ventilated / Automatic
REFRIGERANT: R290
TEMPERATURE: +1 / 8°C
POWER: 180 Watt - 230 V

INFO

Stainless steel construction
Self reversed doors up to 90°
Stainless steel adjustable feet
Right side compressor
60 mm insulation

■ **1.790 €** + V.A.T.



313100

REFRIGERATED COUNTER

DIMENSIONS: 1795x700x860 mm
CAPACITY: 406 lt
DOORS: 3
GRIDS: 3 (53x32,5 cm) plastic laminated
COOLING/DEFROST: Ventilated / Automatic
REFRIGERANT: R290
TEMPERATURE: +1 / 8°C
POWER: 270 Watt - 230 V

INFO

Stainless steel construction
Self reversed doors up to 90°
Stainless steel adjustable feet
Right side compressor
60 mm insulation

■ **2.090 €** + V.A.T.



314100

REFRIGERATED COUNTER

DIMENSIONS: 2230x700x860 mm
CAPACITY: 550 lt
DOORS: 4
GRIDS: 4 (53x32,5 cm) plastic laminated
COOLING/DEFROST: Ventilated / Automatic
REFRIGERANT: R290
TEMPERATURE: +1 / 8°C
POWER: 310 Watt - 230 V

INFO

Stainless steel construction
Self reversed doors up to 90°
Stainless steel adjustable feet
Right side compressor
60 mm insulation

■ **2.490 €** + V.A.T.

Cooling cabinets

220600

COOLING CABINET

DIMENSIONS EXT.: 680x810x2010 mm

DIMENSIONS INT.: 564x680x1394 mm

CAPACITY: 535 lt

DOORS: 1

GRIDS: 3

COOLING: Ventilated

DEFROSTING: Automatic

REFRIGERANT: R290

TEMPERATURE: +1 / 8°C

POWER: 300 Watt - 230 V

INFO

Stainless steel construction

Grids plastic laminated

Stainless steel adjustable feet

60 mm insulation

■ **2.095 €** + V.A.T.



211200

COOLING CABINET

DIMENSIONS EXT.: 1340x810x2010 mm

DIMENSIONS INT.: 1120x680x1394 mm

CAPACITY: 1156 lt

DOORS: 2

GRIDS: 3+3

COOLING: Ventilated

DEFROSTING: Automatic

REFRIGERANT: R290

TEMPERATURE: +1 / 8°C

POWER: 380 Watt - 230 V

INFO

Stainless steel construction

Grids plastic laminated

Stainless steel adjustable feet

60 mm insulation

■ **2.790 €** + V.A.T.



Freezing cabinets



100600

FREEZING CABINET

DIMENSIONS EXT.: 680x810x2010 mm
DIMENSIONS INT.: 564x680x1394 mm
CAPACITY: 507 lt
DOORS: 1
GRIDS: 3
COOLING: Ventilated
DEFROSTING: Automatic
REFRIGERANT: R290
TEMPERATURE: 0 / -18°C
POWER: 585 Watt - 230 V

INFO

Stainless steel construction
Grids plastic laminated
Stainless steel adjustable feet
60 mm insulation

■ **2.195 €** + V.A.T.



101200

FREEZING CABINET

DIMENSIONS EXT.: 1340x810x2010 mm
DIMENSIONS INT.: 1120x68x1394 mm
CAPACITY: 1156 lt
DOORS: 2
GRIDS: 3+3
COOLING: Ventilated
DEFROSTING: Automatic
REFRIGERANT: R290 TEMPERATURE: 0 / -18°C
POWER: 760 Watt - 230 V

INFO

Stainless steel construction
Grids plastic laminated
Stainless steel adjustable feet
60 mm insulation

■ **2.960 €** + V.A.T.

Gastronorme containers

CODE	DESCRIPTION	THICKNESS	LT	PRICE
------	-------------	-----------	----	-------

INOX AISI304 53x65 cm

GN 2120	GN 2/1 20 mm depth	0,70 mm	5,00	41,00 € + V.A.T.
GN 2140	GN 2/1 40 mm depth	0,70 mm	10,00	44,50 € + V.A.T.
GN 2165	GN 2/1 65 mm depth	0,80 mm	18,50	53,50 € + V.A.T.
GN 21100	GN 2/1 100 mm depth	0,80 mm	28,50	60,00 € + V.A.T.
GN 21150	GN 2/1 150 mm depth	0,80 mm	42,50	98,00 € + V.A.T.
GN 21200	GN 2/1 200 mm depth	0,80 mm	57,50	105,00 € + V.A.T.

INOX AISI304 53x32,5 cm

GN 1120	GN 1/1 20 mm depth	0,60 mm	2,50	19,50 € + V.A.T.
GN 1140	GN 1/1 40 mm depth	0,60 mm	5,00	20,50 € + V.A.T.
GN 1165	GN 1/1 65 mm depth	0,60 mm	9,00	23,00 € + V.A.T.
GN 11100	GN 1/1 100 mm depth	0,60 mm	14,00	28,50 € + V.A.T.
GN 11150	GN 1/1 150 mm depth	0,60 mm	21,00	39,00 € + V.A.T.
GN 11200	GN 1/1 200 mm depth	0,70 mm	28,00	50,00 € + V.A.T.

INOX AISI304 35,4x32,5 cm

GN 2320	GN 2/3 20 mm depth	0,60 mm	1,50	15,50 € + V.A.T.
GN 2340	GN 2/3 40 mm depth	0,60 mm	3,00	17,00 € + V.A.T.
GN 2365	GN 2/3 65 mm depth	0,60 mm	5,50	22,00 € + V.A.T.
GN 23100	GN 2/3 100 mm depth	0,60 mm	9,00	25,00 € + V.A.T.
GN 23150	GN 2/3 150 mm depth	0,60 mm	13,00	35,00 € + V.A.T.
GN 23200	GN 2/3 200 mm depth	0,70 mm	18,00	45,50 € + V.A.T.

INOX AISI304 32,5x26,5 cm

GN 1220	GN 1/2 20 mm depth	0,60 mm	1,25	12,50 € + V.A.T.
GN 1240	GN 1/2 40 mm depth	0,60 mm	2,00	14,50 € + V.A.T.
GN 1265	GN 1/2 65 mm depth	0,60 mm	4,00	16,00 € + V.A.T.
GN 12100	GN 1/2 100 mm depth	0,60 mm	6,50	19,50 € + V.A.T.
GN 12150	GN 1/2 150 mm depth	0,60 mm	5,50	26,00 € + V.A.T.
GN 12200	GN 1/2 200 mm depth	0,70 mm	12,50	36,50 € + V.A.T.

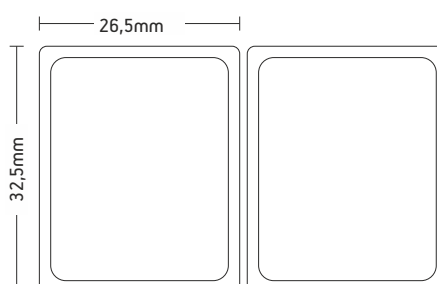
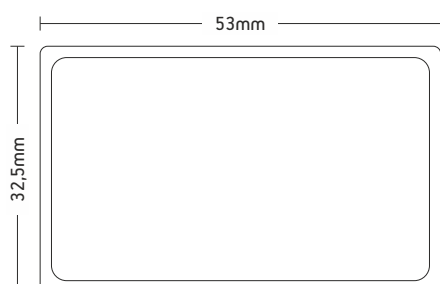
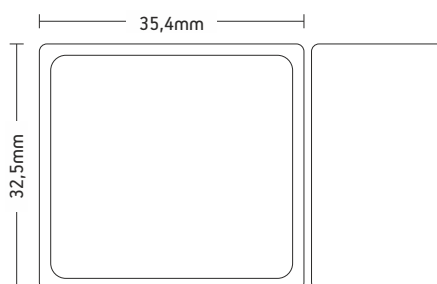
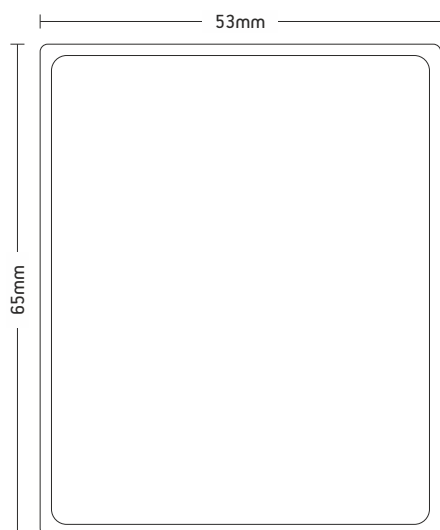



CODE	DESCRIPTION	THICKNESS	LT	PRICE
------	-------------	-----------	----	-------

INOX AISI304 53x65 cm

GN 1320	GN 1/3 20 mm depth	0,60 mm	0,75	10,30 € + V.A.T.
GN 1340	GN 1/3 40 mm depth	0,60 mm	1,50	12,00 € + V.A.T.
GN 1365	GN 1/3 65 mm depth	0,60 mm	2,50	13,00 € + V.A.T.
GN 13100	GN 1/3 100 mm depth	0,60 mm	4,00	16,00 € + V.A.T.
GN 13150	GN 1/3 150 mm depth	0,60 mm	5,70	25,00 € + V.A.T.
GN 13200	GN 1/3 200 mm depth	0,70 mm	7,80	34,00 € + V.A.T.



INOX AISI304 53x32,5 cm

GN 1420	GN 1/4 20 mm depth	0,60 mm	0,50	9,80 € + V.A.T.
GN 1440	GN 1/4 40 mm depth	0,60 mm	1,20	11,50 € + V.A.T.
GN 1465	GN 1/4 65 mm depth	0,60 mm	1,80	12,50 € + V.A.T.
GN 14100	GN 1/4 100 mm depth	0,60 mm	2,80	15,00 € + V.A.T.
GN 14150	GN 1/4 150 mm depth	0,70 mm	4,00	21,80 € + V.A.T.
GN 14200	GN 1/4 200 mm depth	0,70 mm	5,50	32,00 € + V.A.T.



INOX AISI304 35,4x32,5 cm

GN 1665	GN 1/6 65 mm depth	0,60 mm	0,10	8,50 € + V.A.T.
GN 16100	GN 1/6 100 mm depth	0,60 mm	1,60	10,30 € + V.A.T.
GN 16150	GN 1/6 150 mm depth	0,70 mm	2,40	21,80 € + V.A.T.
GN 16200	GN 1/6 200 mm depth	0,70 mm	3,40	28,50 € + V.A.T.

INOX AISI304 32,5x26,5 cm

GN 1965	GN 1/9 65 mm depth	0,70 mm	0,60	8,00 € + V.A.T.
GN 19100	GN 1/9 100 mm depth	0,70 mm	1,00	13,00 € + V.A.T.



INOX AISI304

GNL 21	LID GN 2/1	0,70 mm		38,00 € + V.A.T.
GNL 11	LID GN 1/1	0,60 mm		20,00 € + V.A.T.
GNL 23	LID GN 2/3	0,60 mm		16,50 € + V.A.T.
GNL 12	LID GN 1/2	0,60 mm		12,00 € + V.A.T.
GNL 13	LID GN 1/3	0,60 mm		10,00 € + V.A.T.
GNL 14	LID GN 1/4	0,60 mm		8,50 € + V.A.T.
GNL 16	LID GN 1/6	0,60 mm		6,80 € + V.A.T.
GNL 19	LID GN 1/9	0,60 mm		5,80 € + V.A.T.

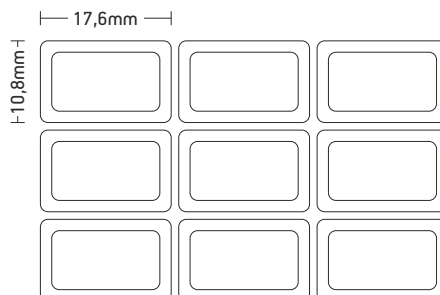
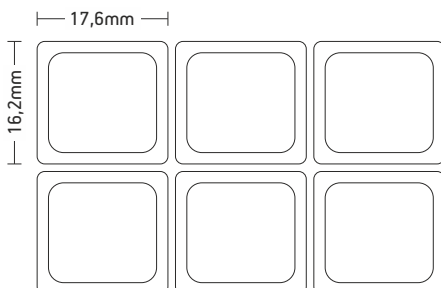
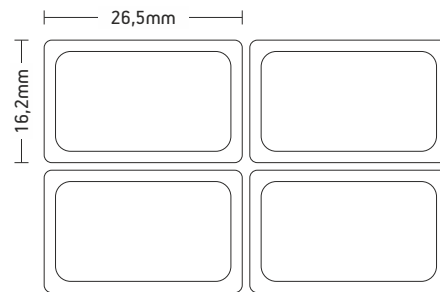
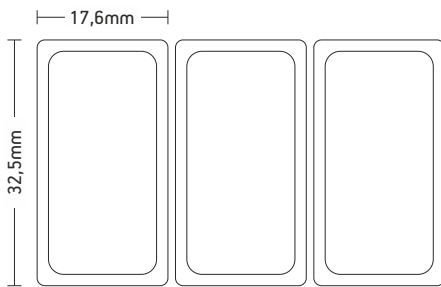

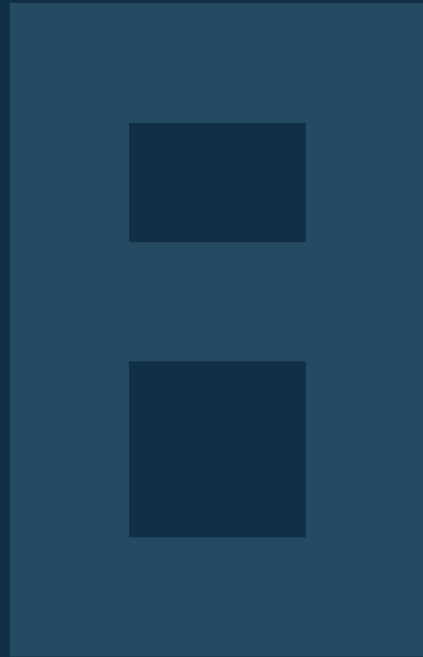
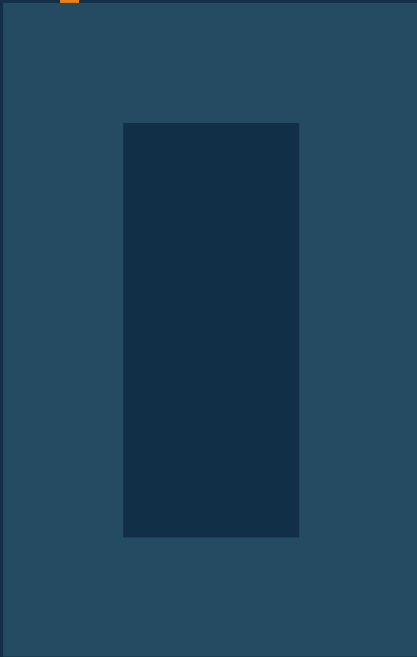

DEEP FREEZERS

BLAST CHILLERS SHOCK FREEZERS



Blast chillers / Shock freezers

MX 3.10 C

BLAST CHILLER / SHOCK FREEZER

CAPACITY: 3 GN 1/1 or 3 GN 2/3
BLAST CHILLING AT 90': +90°C → +3°C 10 kg
DEEP FREEZING AT 240': +90°C → -18°C 5 kg
DIMENSIONS EXT.: 655x715x510/530 mm
INSULATION: 50 mm
LEVELS DISTANCE: 65 mm
POWER: 0.9 kw / 230V / 5 A
REFRIGERANT: R452a

INFO

Cooling capacity 1.16 Kw *Evaporation temperature -10°C

■ **4.100 €** + V.A.T.



MXT 5.20

BLAST CHILLER / SHOCK FREEZER

CAPACITY: 5 GN 1/1 or 5 trays 40x60 cm
BLAST CHILLING AT 90': +90°C → +3°C 20 kg
DEEP FREEZING AT 240': +90°C → -18°C 12 kg
DIMENSIONS EXT.: 798x700x835/865 mm
INSULATION: 70 mm
LEVELS DISTANCE: 65 mm
POWER: 1.3 kw / 230V / 7 A
REFRIGERANT: R452a

INFO

Cooling capacity 1.75 Kw *Evaporation temperature -10°C

■ **6.600 €** + V.A.T.



MXT 7.30

BLAST CHILLER / SHOCK FREEZER

CAPACITY: 7 GN 1/1 or 7 λαμαρίνες 40x60 cm
BLAST CHILLING AT 90': +90°C → +3°C 30 kg
DEEP FREEZING AT 240': +90°C → -18°C 18 kg
DIMENSIONS EXT.: 798x815x995/1025 mm
INSULATION: 70 mm
LEVELS DISTANCE: 65 mm
POWER: 1.5 kw / 230V / 8.5 A
REFRIGERANT: R452a

INFO

Cooling capacity 3.2 Kw *Evaporation temperature -10°C

■ **7.800 €** + V.A.T.





MXT 10.35

BLAST CHILLER / SHOCK FREEZER

CAPACITY: 10 GN 1/1 or 10 trays 40x60 cm
 BLAST CHILLING AT 90': +90°C → +3°C 35 kg
 DEEP FREEZING AT 240': +90°C → -18°C 18 kg
 DIMENSIONS EXT.: 798x808x1480/1520 mm
 INSULATION: 70 mm
 LEVELS DISTANCE: 65 mm
 POWER: 1.6 kw / 230V / 9 A
 REFRIGERANT: R452a

INFO

Cooling capacity 3.2 kW *Evaporation temperature -10°C

■ **9.390 €** + V.A.T.

MXT 14.50

BLAST CHILLER / SHOCK FREEZER

CAPACITY: 14 GN 1/1 or 14 trays 40x60 cm
 BLAST CHILLING AT 90': +90°C → +3°C 50 kg
 DEEP FREEZING AT 240': +90°C → -18°C 30 kg
 DIMENSIONS EXT.: 798x808x1860/1900 mm
 INSULATION: 70 mm
 LEVELS DISTANCE: 65 mm
 POWER: 3 kw / 230V / 11 A
 REFRIGERANT: R452a

INFO

Cooling capacity 3.9 kW *Evaporation temperature -10°C

■ **13.850 €** + V.A.T.

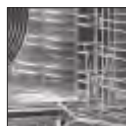

High quality AISI 304 18/10 stainless steel. Scotch Brite external, mirror internal.

Certified Italian high performances refrigerating units.

Special fans suitable for low temperature with speed adjusting system.

Inner rounded angles and curved bottom for easy cleaning.

Oversized powerful condenser.

Anticorrosion cataphoresis coated evaporators to ensure high reliability.



C O O K I N G

COUNTERTOP ELECTRIC STOVES [170]
COUNTERTOP GAS STOVES [171]
COUNTERTOP ELECTRIC FRYERS [172]
BAIN MARIE & NEUTRALS [173]
ELECTRIC GRIDDLE PLATES [174]
CHROME PLATED ELECTRIC GRIDDLE PLATES [175]
GAS GRIDDLE PLATES [176]
CHROME PLATED GAS GRIDDLE PLATES [177]
ELECTRIC WATER GRILLS [178]
ELECTRIC & GAS RANGES WITH OVEN [178]
FLOOR MOUNTED GAS FRYERS [179]
FLOOR MOUNTED ELECTRIC & GAS PASTA COOKERS [180]
ELECTRIC & GAS TILTING BRATT PANS [180]
FLOOR MOUNTED INDUCTION COOKERS [181]
GAS FREE STANDING RANGES [181]

KITCHEN EQUIPMENT SERIES 70

Stoves

COUNTERTOP ELECTRIC STOVES

kitchen equipment
series 70

made in
POLAND



9705000

ELECTRIC STOVE

DIMENSIONS: 400x700x250 mm
POWER: 2 x 2,6 Kw/400V
PLATES: Electric
PLATE DIAMETER: 220 mm

■ 795 € + V.A.T.



9706000

ELECTRIC STOVE

DIMENSIONS: 800x700x250 mm
POWER: 4 x 2,6 Kw/400V
PLATES: Electric
PLATE DIAMETER: 220 mm

■ 1.170 € + V.A.T.



9707000

ELECTRIC STOVE

DIMENSIONS: 1200x700x250 mm
POWER: 6 x 2,6 Kw/400V
PLATES: Electric
PLATE DIAMETER: 220 mm

■ 1.540 € + V.A.T.



9705500

ELECTRIC STOVE

DIMENSIONS: 400x700x250 mm
POWER: 2 x 2,5 Kw/400V
PLATES: Ceramic
PLATE DIAMETER: 225 mm

■ 1.030 € + V.A.T.



9706500

ELECTRIC STOVE

DIMENSIONS: 800x700x250 mm
POWER: 4 x 2,5 Kw/400V
PLATES: Ceramic
PLATE DIAMETER: 225 mm

■ 1.800 € + V.A.T.



Stoves

COUNTERTOP GAS STOVES

stalga
professional catering equipment



9705230

GAS STOVE

DIMENSIONS: 400x700x250 mm

POWER: 1x3,5 + 1x7 Kw

BURNERS: Gas

INFO

Pilot flame

Anti leakage safety device

■ **1.045 €** + V.A.T.



9706330

GAS STOVE

DIMENSIONS: 800x700x250 mm

POWER: 2x5 + 2x7 Kw

BURNERS: Gas

INFO

Pilot flame

Anti leakage safety device

■ **1.720 €** + V.A.T.



9707230

GAS STOVE

DIMENSIONS: 1200x700x250 mm

POWER: 1x3,5 + 2x5 + 2x7 + 1x9 Kw

BURNERS: Gas

INFO

Pilot flame

Anti leakage safety device

■ **2.245 €** + V.A.T.

Fryers

COUNTERTOP ELECTRIC FRYERS

kitchen equipment
series 70

made in
POLAND



9725000

ELECTRIC FRYER

DIMENSIONS: 400x700x250 mm
CAPACITY: 10 lt
POWER: 9 Kw / 400 V
BASKET DIMENSIONS: 210x350x110 mm

INFO

Cold zone system
Oil tap
Safety thermostat

■ **1.955 €** + V.A.T.



9725500

ELECTRIC FRYER

DIMENSIONS: 400x700x250 mm
CAPACITY: 15 lt
POWER: 15 Kw / 400 V
BASKET DIMENSIONS: 210x350x110 mm

INFO

Cold zone system
Oil tap
Safety thermostat

■ **2.270 €** + V.A.T.



9726000

ELECTRIC FRYER

DIMENSIONS: 800x700x250 mm
CAPACITY: 2x10 lt
POWER: 18 Kw / 400 V
BASKET DIMENSIONS: 210x350x110 mm

INFO

Cold zone system
Oil tap
Safety thermostat

■ **3.085 €** + V.A.T.

9724500

ADJUSTABLE FRIES HEATER

DIMENSIONS: 400x700x440 mm
CAPACITY: GN 1/1
POWER: 1 Kw / 230 V

■ **1.515 €** + V.A.T.





9720000

BAIN MARIE

DIMENSIONS: 400x700x250 mm

CAPACITY: GN1/1-150 mm

POWER: 0,8 Kw / 230V

INFO

Oil tap

■ **1.035 €** + V.A.T.



9721000

BAIN MARIE

DIMENSIONS: 800x700x250 mm

CAPACITY: GN1/1-150 mm

POWER: 1,6 Kw / 230V

INFO

Oil tap

■ **1.555 €** + V.A.T.



9700210

NEUTRAL

DIMENSIONS: 400x700x250 mm

INFO

Full extension drawer

■ **550 €** + V.A.T.



9700410

NEUTRAL

DIMENSIONS: 800x700x250 mm

INFO

Full extension drawer

■ **700 €** + V.A.T.

Griddle Plates

ELECTRIC

kitchen equipment
series 70

 made in
POLAND



9730100

ELECTRIC GRIDDLE PLATE

DIMENSIONS: 400x700x250 mm
POWER: 4 Kw/400V
SURFACE: Smooth

INFO

Grease drawer
Safety thermostat

■ **1.375 €** + V.A.T.



9730200

ELECTRIC GRIDDLE PLATE

DIMENSIONS: 400x700x250 mm
POWER: 4 Kw/400V
SURFACE: Ribbed

INFO

Grease drawer
Safety thermostat

■ **1.600 €** + V.A.T.



9731100

ELECTRIC GRIDDLE PLATE

DIMENSIONS: 800x700x250 mm
POWER: 8,1 Kw/400V
SURFACE: Smooth

INFO

Grease drawer
Safety thermostat

■ **2.175 €** + V.A.T.

9731200

ELECTRIC GRIDDLE PLATE

DIMENSIONS: 800x700x250 mm
POWER: 8,1 Kw/400V
SURFACE: Ribbed

INFO

Grease drawer
Safety thermostat

■ **2.325 €** + V.A.T.



9731300

ELECTRIC GRIDDLE PLATE

DIMENSIONS: 800x700x250 mm
POWER: 8,1 Kw/400V
SURFACE: ½ Smooth & ½ Ribbed

INFO

Grease drawer
Safety thermostat

■ **2.325 €** + V.A.T.



Chromium Griddle Plates



ELECTRIC

NEW



9736100

CHROME PLATED ELECTRIC GRIDDLE

DIMENSIONS: 400x700x250 mm
POWER: 4 Kw/400V
SURFACE: Smooth chrome plated

INFO

Grease drawer
Safety thermostat

■ **1.595 €** + V.A.T.

NEW



9736200

CHROME PLATED ELECTRIC GRIDDLE

DIMENSIONS: 400x700x250 mm
POWER: 4 Kw/400V
SURFACE: Ribbed chrome plated

INFO

Grease drawer
Safety thermostat

■ **1.790 €** + V.A.T.

NEW



9737100

CHROME PLATED ELECTRIC GRIDDLE

DIMENSIONS: 800x700x250 mm
POWER: 8,1 Kw/400V
SURFACE: Smooth chrome plated

INFO

Grease drawer
Safety thermostat

■ **2.455 €** + V.A.T.

NEW



9737200

CHROME PLATED ELECTRIC GRIDDLE

DIMENSIONS: 800x700x250 mm
POWER: 8,1 Kw/400V
SURFACE: Ribbed chrome plated

INFO

Grease drawer
Safety thermostat

■ **2.710 €** + V.A.T.

NEW



9737300

CHROME PLATED ELECTRIC GRIDDLE

DIMENSIONS: 800x700x250 mm
POWER: 8,1 Kw/400V
SURFACE: 1/2 smooth & 1/2 ribbed chrome plated

INFO

Grease drawer
Safety thermostat

■ **2.710 €** + V.A.T.

Griddle Plates

GAS

kitchen equipment
series 70

made in
POLAND



9730130

GAS GRIDDLE PLATES

DIMENSIONS: 400x700x250 mm
POWER: 6,5 Kw
SURFACE: Smooth

INFO

Grease drawer
Safety thermostat

■ **1.720 €** + V.A.T.



9730230

GAS GRIDDLE PLATES

DIMENSIONS: 400x700x250 mm
POWER: 6,5 Kw
SURFACE: Ribbed

INFO

Grease drawer
Safety thermostat

■ **1.735 €** + V.A.T.



9731130

GAS GRIDDLE PLATES

DIMENSIONS: 800x700x250 mm
POWER: 13 Kw
SURFACE: Smooth

INFO

Grease drawer
Safety thermostat

■ **3.030 €** + V.A.T.



9731230

GAS GRIDDLE PLATES

DIMENSIONS: 800x700x250 mm
POWER: 13 Kw
SURFACE: Ribbed

INFO

Grease drawer
Safety thermostat

■ **3.030 €** + V.A.T.



9731330

GAS GRIDDLE PLATES

DIMENSIONS: 800x700x250 mm
POWER: 13 Kw
SURFACE: ½ smooth & ½ ribbed

INFO

Grease drawer
Safety thermostat

■ **3.030 €** + V.A.T.

Chromium Griddle Plates

GAS

NEW



9736130

CHROME PLATED GAS GRIDDLE

DIMENSIONS: 400x700x250 mm
POWER: 6,5 kW
SURFACE: Smooth chrome plated

INFO

Grease drawer
Safety thermostat

■ **1.970 €** + V.A.T.

NEW



9736230

CHROME PLATED GAS GRIDDLE

DIMENSIONS: 400x700x250 mm
POWER: 6,5 kW
SURFACE: Ribbed chrome plated

INFO

Grease drawer
Safety thermostat

■ **2.070 €** + V.A.T.

NEW



9737130

CHROME PLATED GAS GRIDDLE

DIMENSIONS: 800x700x250 mm
POWER: 13 kW
SURFACE: Smooth chrome plated

INFO

Grease drawer
Safety thermostat

■ **3.730 €** + V.A.T.

NEW



9737230

CHROME PLATED GAS GRIDDLE

DIMENSIONS: 800x700x250 mm
POWER: 13 kW
SURFACE: Ribbed chrome plated

INFO

Grease drawer
Safety thermostat

■ **3.730 €** + V.A.T.

NEW



9737330

CHROME PLATED GAS GRIDDLE

DIMENSIONS: 800x700x250 mm
POWER: 13 kW
SURFACE: ½ smooth & ½ ribbed chrome plated

INFO

Grease drawer
Safety thermostat

■ **3.730 €** + V.A.T.

Water Grills

ELECTRIC

NEW



9732000

ELECTRIC WATER GRILL

DIMENSIONS: 400x700x250 mm
POWER: 4.08 Kw

INFO
Safety thermostat

■ **2.190 €** + V.A.T.

kitchen equipment
series 70

made in
POLAND



NEW



9733000

ELECTRIC WATER GRILL

DIMENSIONS: 800x700x250 mm
POWER: 8.16 Kw

INFO
Safety thermostat

■ **3.590 €** + V.A.T.

Ranges with ovens

ELECTRIC & GAS



9715000

ELECTRIC RANGE WITH ELECTRIC OVEN

DIMENSIONS: 800x700x850 mm
PLATES: Electric, 4x2.6 kW
OVEN: Electric, 7 kW
TOTAL POWER: 17.4 kW / 400 V
PLATE DIAMETER: 220 mm

OVEN DIMENSIONS: 660x445x285 mm

INFO
Oven suitable for GN 1/1 & 40x60 cm trays
Oven cooking modes:
Static
Air flow
Humidity injection

■ **3.020 €** + V.A.T.



9710330

GAS RANGE WITH GAS OVEN

DIMENSIONS: 800x700x850 mm
PLATES: Gas, 2x5 kW & 2x7 kW
OVEN: Gas, 6 kW
TOTAL POWER: 30 kW

OVEN DIMENSIONS: 660x545x285 mm

INFO
Oven suitable for GN 2/1
Oven cooking modes:
Static

■ **2.990 €** + V.A.T.



9715330

GAS RANGE WITH ELECTRIC OVEN

DIMENSIONS: 800x700x850 mm

PLATES: Gas, 2x5 kW & 2x7 kW

OVEN: Electric 7 kW

TOTAL POWER: 30 kW

OVEN DIMENSIONS: 660x445x285 mm

INFO

Oven suitable for GN 1/1

Oven cooking modes:

Static

Air flow

Humidity injection

■ **3.430 €** + V.A.T.

Fryers

FLOOR MOUNTED GAS FRYERS



9725130

GAS FRYER SINGLE

DIMENSIONS: 400x700x850 mm

CAPACITY: 17 lt

POWER: 15 kW

BASKET DIMENSIONS: 310x300x120 mm

INFO

Pilot flame

Anti leakage safety device

■ **2.910 €** + V.A.T.

9725230

GAS FRYER DOUBLR

DIMENSIONS: 400x700x850 mm

CAPACITY: 2x7 lt

POWER: 12 kW

BASKET DIMENSIONS: 130x300x120 mm

INFO

Pilot flame

Anti leakage safety device

■ **4.120 €** + V.A.T.

Pasta cookers

FLOOR MOUNTED ELECTRIC & GAS

kitchen equipment
series 70

made in
POLAND



9745000

ELECTRIC PASTA COOKER

DIMENSIONS: 400x700x850 mm

CAPACITY: 25 lt

POWER: 6 kW / 400 V

INFO

Water drain

Safety thermostat

Baskets not included

COMBINATIONS

Basket GN 1/3 x 2 pcs

Basket GN 1/6 x 4 pcs

Basket 1x GN 1/3 + 2 x GN 1/6

■ **2.160 €** + V.A.T.

9745130

GAS PASTA COOKER

DIMENSIONS: 400x700x850 mm

CAPACITY: 25 lt

POWER: 9.1 kW

INFO

Water drain

Safety thermostat

Baskets not included

COMBINATIONS

Basket GN 1/3 x 2 pcs

Basket GN 1/6 x 4 pcs

Basket 1x GN 1/3 + 2 x GN 1/6

■ **2.740 €** + V.A.T.

BASKETS CODES

9799920 GN 1/3

9799930 GN 1/6



Tilting bratt pans

ELECTRIC & GAS

9740000

ELECTRIC TILTING BRATT PAN

DIMENSIONS: 800x700x850 mm

CAPACITY: 58 lt

POWER: 10.8 kW / 400 V

INFO

Manual tilting

■ **4.500 €** + V.A.T.

9740030

GAS TILTING BRATT PAN

DIMENSIONS: 800x700x850 mm

CAPACITY: 58 lt

POWER: 17 kW

INFO

Manual tilting

■ **4.600 €** + V.A.T.

Induction cookers

FLOOR MOUNTED

9705100

INDUCTION COOKER

DIMENSIONS: 400x700x850 mm
POWER: 7 kW / 400 V
PLATES: 2 induction
PLATE DIAMETER: 250 mm

■ **4.090 €** + V.A.T.

NEW



9706100

INDUCTION COOKER

DIMENSIONS: 800x700x850 mm
POWER: 14 kW / 400 V
PLATES: 4 induction
PLATE DIAMETER: 250 mm

■ **7.200 €** + V.A.T.

Gas ranges

FREE STANDING

979533

FREE STANDING GAS RANGE

DIMENSIONS: 800x700x850 mm
POWER: 2x5 + 2x7 kW
BURNERS: Gas

INFO

Pilot flame
Anti leakage safety device

■ **1.980 €** + V.A.T.



979623

FREE STANDING GAS RANGE

DIMENSIONS: 1200x700x850 mm
POWER: 1x3,5 + 2x5 + 2x7 + 1x9 kW
BURNERS: Gas

INFO

Pilot flame
Anti leakage safety device

■ **2.820 €** + V.A.T.





S T O R I N G



DOORS [184]
REFRIGERATION SYSTEMS [188]
COLD ROOMS [189]
COLD ROOM SHELVES [190]

DOORS/COLD ROOM/SHELVES

STORING
DOORS \ COLD ROOMS \ SHELVES

183



Doors

HINGED & SLIDING



Standard characteristics

- Door insulation made of high density polyurethane 40 kg/m³
- Door lining made of laminated metal sheet 0.5 mm thick
- CSI safety latch with lock certified to EN 179:2008
- Heavy duty 3D adjustable hinges
- Insulated case
- High quality rubber door seals
- Single door/ Double door
- Inox version
- Wide variety of available RAL
- Custom dimensions
- Thermal resistance in rubber door seal or door frame (freezer version)

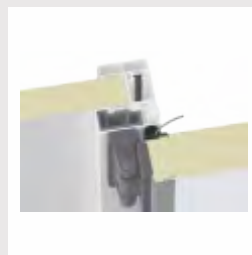

TYPE	TEMPERATURE	THICKNESS	THERMAL RESISTANCE	MEAT RAIL PASSAGE
500 TN	Cooling (+0°C)	68 mm	-	-
GV5	Cooling (+0°C)	68 mm	-	-
603 LWT	Freezing (-20°C)	92 mm	Rubber door seal	-
604 LWT	Freezing (-25°C)	121 mm	Rubber door seal	-
740 LWT	Freezing (-30°C)	121 mm	Door frame	-
745 LWT	Freezing (-40°C)	121 mm	Door frame & rubber seal	-
750 LWT	Freezing (-45°C)	151 mm	Door frame & rubber seal	-

since 1942

MTH

 100% MADE IN ITALY



Standard characteristics

- Door insulation made of high density polyurethane 40 kg/m³
- Door lining made of laminated metal sheet 0.5 mm thick
- Lever type handle or fixed depending on the version
- Thermally insulated door frame
- High quality rubber door seals
- Single door/ Double door
- Inox version
- Wide variety of available RAL
- Custom dimensions
- Thermal resistance in rubber door seal or door frame (freezer version)
- Door automation



TYPE	TEMPERATURE	THICKNESS	THERMAL RESISTANCE	MEAT RAIL PASSAGE
360 LS/FLS	Cooling (+0°C)	68 mm	-	-
480 PT	Cooling (+0°C)	68 mm	-	-
480 TN	Cooling (-5°C)	92 mm	Rubber door seal	-
480 LT	Freezing (-20°C)	92 mm	Rubber door seal	-
480 LTB	Freezing (-25°C)	121 mm	Rubber door seal	-
480 LWT	Freezing (-30°C)	121 mm	Door frame & rubber seal	-
485 LWT	Freezing (-40°C)	121 mm	Door frame & rubber seal	-
490 LWT	Freezing (-45°C)	151 mm	Door frame & rubber seal	-

Cold Room Doors

SEMI-INSULATING

since 1942

MTH



100% MADE IN ITALY



Standard characteristics

VA E VIENI

- Door insulation made of high density polyurethane 40 kg/m³
- Door lining made of laminated sheet 0.5 mm thick
- Hinges with stop at 90°
- High quality rubber door seals
- Single door/ Double door
- Stainless steel protection on the lower part of the door 30 cm high
- Oblo window 25x75 cm
- Inox or polyethylene version
- Wide variety of available RAL
- Custom dimensions

SERVICE DOOR

- Door insulation made of high density polyurethane 40 kg/m³
- Door lining made of laminated sheet 0.5 mm thick
- Aluminum door frame
- High quality rubber door seals
- Single door/ Double door
- Inox version
- Wide variety of available RAL
- Custom dimensions

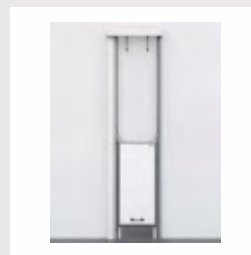
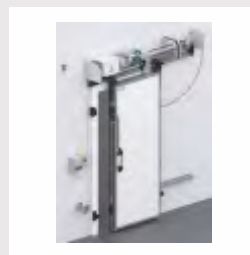

TYPE	TEMPERATURE	THICKNESS	THERMAL RESISTANCE	MEAT RAIL PASSAGE
CA	Cooling (+0°C)	92 mm	-	-
480 PGV	Cooling (+0°C)	68 mm	-	-
450 GV	Cooling (+0°C)	92 mm	-	-
240 AM	Cooling (+0°C)	68 mm	-	-
240 S	Cooling (+0°C)	68 mm	-	-
VERTICAL TN	Cooling (-5°C)	92 mm	-	-
VERTICAL LWT	Freezing (-40°C)	121 mm	Door frame	-

Hygienic Profiles

since 1942



 100% MADE IN ITALY

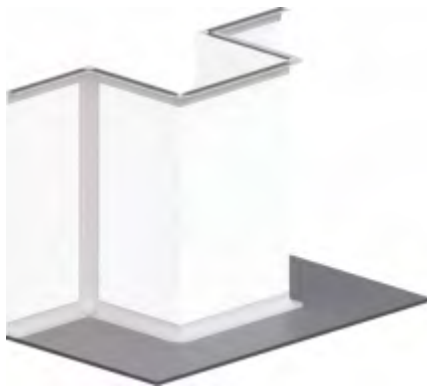

Hygienic profiles and components, suitable for industrial refrigeration, food industry, pharmaceutical warehouses. Complete range of products, ideal for compliance with sanitary regulations. The sanitary corners are used in order to avoid any kind of contamination and to facilitate the cleaning of each area.

12 CEL 500	Sanitary corner PVC 35x35 Length 4000 mm White RAL 9010		
12 CEL 501	Corner profile PVC 30x30 Length 4000 mm		
12 CEL 502	Rounded sanitary corner PVC Length 4000 mm White RAL 9010		
12 CEL 550	Trihedral internal corner White RAL 9010		
12 CEL 551	Dihedral external corner White RAL 9010		
12 CEL 552	Sanitary corner end cap White RAL 9010		

Refrigerants

MONOBLOCK UNITS / AN EMISSION DAYS / MOTORS

since 1942

MTH



100% MADE IN ITALY



Cold Rooms

MODULAR

 100% MADE IN ITALY

Modular cold rooms
cooling & freezing

Panel: 8cm / 10cm / 12cm / 14cm
Dimensional development every 20cm!



Multi-door cabinets
cooling & freezing

STORING
DOORS \ COLD ROOMS \ SHELVES

189

Shelves

COLD ROOM SHELVES

Light Version // M



dimensions

SHELF WIDTH
30 / 40 / 45 / 60 cm

SHELF LENGTH
3.2 cm





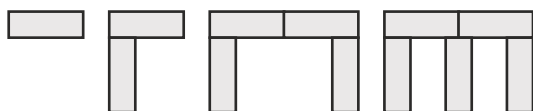

UPRIGHT HEIGHT
155 / 165 / 185 / 205 cm

ADJUSTABLE SHELF HEIGHT
every 15 cm

compositions



technical characteristics

- 
AL+PP +AISI 304 Certified anodised aluminium alloy frame and polypropylene staves
- 
EN AW-6060 Suitable for direct food contact
- 
 Adjustable feet
- 
 Certified weight strength (Eurocode 9) with load capacity **130 – 240 kg** per shelf
- 
 Open-faced corner compositions
- 
 Stable and resistant
- 
HACCP Haccp Standards



SHELF WITH POLYPROPYLENE PERFORATED STAVES

Single perforated stave ideal for 30, 40 and 45 cm shelves

Double perforated stave ideal for 60 cm shelves

SHELF WITH STAINLESS STEEL M-1 AISI 304 COVER

HANGING BARS FOR SALAMI

Available with 2, 3 or 4 bars

134 M

135 M 136 M

Shelves

COLD ROOM SHELVES

Strong Version // M



dimensions

SHELF WIDTH

30 / 40 / 45 / 60 / 70 / 75 /
80 / 85 / 90 cm

SHELF LENGTH

9 cm

UPRIGHT HEIGHT







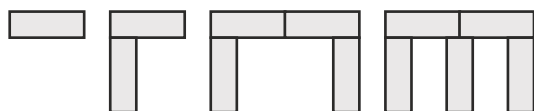

150 / 180 / 200 cm

ADJUSTABLE SHELF HEIGHT
every 15 cm

compositions



technical characteristics

- | | | | |
|-----------------------------------------------------------------------------------|--------------------------------------------------------------------------|-----------------------------------------------------------------------------------|------------------------------------------------------------------------------------------------|
|  | <p>Certified anodised aluminium alloy frame and polypropylene staves</p> |  | <p>Open-faced corner compositions</p> |
|  | <p>Suitable for direct food contact</p> |  | <p>Stable and resistant</p> |
|  | <p>Adjustable feet</p> |  | <p>Haccp Standards</p> |
|  | <p>Easy and quick assembly</p> |  | <p>Certified weight strength (Eurocode 9) with load capacity 175 – 725 kg per shelf</p> |

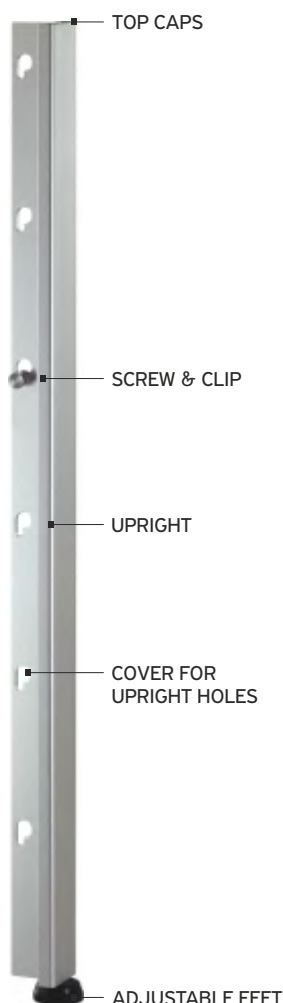

SHELF WITH POLYPROPYLENE STAVES

Single perforated stave ideal for 30, 40 and 45 cm shelves

Double perforated stave ideal for 60, 70, 75, 80, 85 and 90 cm

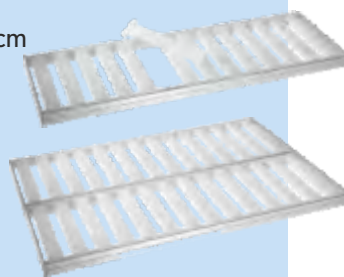

SHELF WITH POLYPROPYLENE PERFORATED STAVES

Q

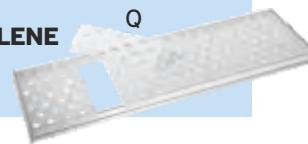

SHELF WITH STAINLESS STEEL AISI 304 COVER

P-1 / Q-1

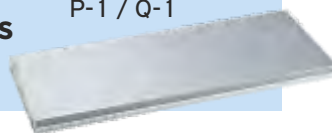

HANGING BARS FOR SALAMI MATURATION

Available with 2, 3 or 4 bars

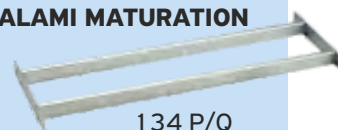

134 P/Q



135 P/Q



136 P/Q



271 Athens Avenue, 124 61 Chaidari, Greece

T +30 210.58.10.600 **F** +30 210.58.10.610 **E** info@ventus.com.gr **S** www.ventus.com.gr